

METRICAL AND PROSODIC STRUCTURE
IN OPTIMALITY THEORY

(Revised November 2001)

BRETT HYDE

METRICAL AND PROSODIC STRUCTURE
IN OPTIMALITY THEORY

by

BRETT D. HYDE

A Dissertation submitted to
the Graduate School-New Brunswick
Rutgers, The State University of New Jersey
in partial fulfillment of the requirements

for the degree of

Doctor of Philosophy

Graduate Program in Linguistics

written under the direction of

Alan Prince

and approved by

New Brunswick, New Jersey

January, 2001

ABSTRACT OF THE DISSERTATION

Metrical and Prosodic Structure in Optimality Theory

by BRETT D. HYDE

Dissertation Director:

Alan Prince

This dissertation examines four components of a theory of metrical stress— the prosodic hierarchy, the system of prosodic prominence, the metrical grid, and the slope category system— and investigates how Optimality Theoretic constraints restrict or facilitate interaction between them. The proposal is comprehensive in that it examines each of the basic types of stress alternation— binary, ternary, and unbounded— both in weight-sensitive and weight-insensitive systems. The proposal’s focus, however, is the discrepancy between the wide range of binary patterns that standard accounts predict and the much smaller range of patterns that are actually attested. Of particular concern is the standard account’s over-generation of iambic patterns. In pursuit of greater restrictiveness, the proposed approach departs from the structural assumptions of current approaches in several ways. The proposed account insists on strict succession (or exhaustive parsing), tolerates improper bracketing, makes violable the foot-stress relationship, and allows prosodic categories to share entries on the metrical grid. The proposal also departs from the standard account in the division of labor between symmetrical constraints, such as Alignment, and asymmetrical constraints, such as NonFinality. Although Alignment still figures prominently in the proposed account, constraints like NonFinality play a more central role in establishing basic typologies. Given the structural assumptions, this shift in emphasis results in a different, and much smaller, range of predicted patterns.

DEDICATION AND ACKNOWLEDGMENT

*This dissertation is dedicated to my wife Haydee
and to the memory of our son Dee Alan.*

There are many who deserve recognition for their part in the completion of this dissertation. Foremost are Mario Pellicciaro, my classics professor from Washington and Lee University, and Alan Prince, the chair of my dissertation committee at Rutgers University. My interest in linguistics began with Mario's analysis of ancient Greek and Latin accent patterns in an introductory classics course and grew during his presentation of transformational grammar in an introductory course on linguistic theory. My interest in metrical stress theory, in particular, was solidified while attending Alan's seminar soon after I arrived at Rutgers. It is mostly due to his constant bar-raising that the proposals in this dissertation have transformed from a handful of ideas into a theory of metrical stress.

This dissertation has also benefited from the input of my committee: Akin Akinlabi and Bruce Tesar from Rutgers University and Laura Benua from the University of Maryland. Each read through numerous failed drafts before I reached the final version. While their criticism of wrong turns was helpful, their praise of promising points was even more so.

I was fortunate in having fellow students at Rutgers willing to discuss the analyses included (and some not included) in this dissertation. Ed Keer, Eric Bakovic, and Nicole Nelson each supplied especially valuable comments and criticisms. I was also fortunate in receiving extensive comments on earlier drafts from the University of Massachusetts' Paul de Lacy. Fortunately for the quality of the dissertation, most of the ideas he criticized did not survive to the final version. Comments on ideas that became components of the final version have come from audiences at Rutgers University, the University of Massachusetts,

the University of Maryland, and the University of North Carolina at Chapel Hill. These have also proved valuable.

Others deserve recognition for roles that were less direct but significant. For their guidance and support during my time at Rutgers, I am indebted to the linguistics department faculty. In addition to the members of my committee, I am especially indebted to Maria Bittner and Ken Safir. I thank both for believing, contrary to all available evidence, that I could make a contribution to linguistic theory. My new colleagues at Washington University, Bill Bechtel and Adele Abrahamsen, have shown extraordinary concern over the completion of this dissertation and over me personally.

Lastly and most importantly, I wish to acknowledge my parents, Dee and Helen Hyde. Their love and support over these past several years, as well as at every other time in my life, has been thoroughly and completely unconditional.

TABLE OF CONTENTS

TITLE PAGE	i
ABSTRACT OF THE DISSERTATION	ii
DEDICATION AND ACKNOWLEDGMENT	iii
TABLE OF CONTENTS	v
INTRODUCTION	1
CHAPTER ONE: ODD SYLLABLES AND ASYMMETRIES	4
1.1 The Standard Account	5
1.2 Two Observations	14
1.3 The Proposal	16
1.3.1 Minimal Alternation	17
1.3.1.1 Strict Succession	18
1.3.1.2 Foot-Head Alignment	19
1.3.1.3 Feet and Stress	22
1.3.1.4 Intersecting Feet	24
1.3.2 Maximal Alternation	28
1.3.2.1 Prosodic Word Alignment	29
1.3.3 NonFinality	34
1.3.3.1 The Double Offbeat Pattern	34
1.3.3.2 The Internal Ternary Pattern	38
1.3.4 Initial Gridmark	41
1.3.4.1 The Double Downbeat Pattern	41
1.3.4.2 The Edge Ternary Pattern	45
1.4 Summary	48

CHAPTER TWO: THREE SYSTEMS	50
2.1 The Prosodic Hierarchy	50
2.1.1 The Traditional Configuration	51
2.1.2 The Intersecting Configuration	52
2.1.3 Overcoming Pathologies	54
2.1.4 Foot Binarity	58
2.1.5 Summary	63
2.2 Prosodic Prominence	64
2.3 The Metrical Grid	69
2.4 Prosodic Hierarchy-Prosodic Prominence Interaction	72
2.4.1 The Weight-to-Head Constraint	74
2.4.2 The Lapse Condition	77
2.5 Metrical Grid-Prosodic Prominence Interaction	81
2.6 Prosodic Hierarchy-Metrical Grid Interactions	86
2.6.1 Gridmark Mapping	86
2.6.2 The Base Level	87
2.6.3 Higher Levels	90
2.6.4 Relativization to Prosodic Heads	93
2.6.5 Summary	94
2.7 Some Objections Countered	95
2.7.1 Restrictiveness	95
2.7.2 Interpretation	98
2.8 Summary	103

CHAPTER THREE: ALIGNMENT CONSTRAINTS	104
3.1 The Locations of Foot-Heads	104
3.1.1 Basic Properties and Restrictions	105
3.1.2 Foot-Head Alignment	110
3.1.2.1 Minimal Alternation: Nengone and Araucanian	113
3.1.2.2 Even-Parity Forms	115
3.1.2.3 Odd-Parity Forms	120
3.1.3 Prosodic Word Alignment	128
3.1.3.1 Maximal Alternation: Maranungku and Suruwaha	130
3.1.3.2 Odd-Parity Forms	133
3.1.3.2.1 Location of Foot-Heads	133
3.1.3.2.2 Foot-Type and Directionality	137
3.1.3.3 Even-Parity Forms	139
3.1.4 Direct Restrictions	144
3.2 Prosodic Word-Head Alignment	148
3.3 Gridmark Alignment	154
3.3.1 Alignment of Mora-Level Gridmarks	155
3.3.1.1 Monopositional and Bipositional Mapping	157
3.3.2 Alignment of Foot-Level Gridmarks	160
3.3.2.1 Interactions	163
3.3.2.1.1 Minimal Structure	164
3.3.2.1.2 Directionality	169
3.3.2.2 Unbounded Stress Systems: Tinrin and Uzbek	172
3.3.2.3 A Ternary Pattern: Chugach	178
3.3.3 Restrictions on Gridmark Alignment	184
3.4 Summary	188

CHAPTER FOUR: ASYMMETRICAL CONSTRAINTS	191
4.1 The Slope Category System	192
4.2 NonFinality	196
4.2.1 Syllabic NonFinality in the Prosodic Word	198
4.2.1.1 Binary NonFinality Patterns	199
4.2.1.1.1 Constraint Interactions	203
4.2.1.1.2 Stressed Final Iamb	210
4.2.1.1.3 Stressless Final Iamb: Choctaw and Pintupi	215
4.2.1.1.4 Stressed Final Trochee: Aguaruna and Piro	219
4.2.1.1.5 Predicting Asymmetries	224
4.2.1.1.6 Summary	230
4.2.1.2 Unbounded NonFinality Patterns: Yawelmani	231
4.2.2 Syllabic NonFinality within the Foot	234
4.2.2.1 Trochees	237
4.2.2.2 Minimality	241
4.2.3 Summary	243
4.3 Initial Gridmark	243
4.3.1 Constraint Interactions	247
4.3.2 Gridmark Sharing: Minimal Alternation	256
4.3.3 Clash Configuration: Passamaquoddy	259
4.3.4 Stressless Second Foot: Garawa	261
4.3.5 Predicting Asymmetries	264
4.3.6 Summary	266
4.3.7 Chimalapa Zoque	267
4.4 Window Constraints	272
4.4.1 Window Constraints in the Prosodic Word Domain	273

4.4.2	Trisyllabic Stress Windows	274
4.4.2.1	Trisyllabic Windows at the Right Edge	279
4.4.2.2	Trisyllabic Windows at the Left Edge	284
4.4.3	Influencing Footing Directionality	287
4.4.4	Influencing Syllable Weight	293
4.5	Summary	301
CHAPTER FIVE: WEIGHT-SENSITIVITY		303
5.1	Weight to Stress	305
5.1.1	Hixkaryana	306
5.1.2	Moraic Windows in the Foot	309
5.1.3	Combined Effects	312
5.1.4	Cahuilla	315
5.1.5	Summary	322
5.2	Stress to Weight	322
5.2.1	Moraic NonFinality within the Prosodic Word	323
5.2.1.1	Constraint Interactions	326
5.2.1.2	A Mixed System: Wergaia	330
5.2.2	Moraic NonFinality within the Foot	334
5.2.2.1	Constraints Interactions	336
5.2.2.2	Iambic Lengthening: Choctaw	340
5.2.3	NonFinality within the Syllable	343
5.2.3.1	Constraint Interactions	346
5.2.3.2	Iambic Lengthening: Hixkaryana	348
5.2.3.3	Trochaic Lengthening: Chimalapa Zoque	354
5.3	Unbounded Stress Systems	357
5.3.1	Defaults to Same Side	357

5.3.1.1 Leftward Default: Murik	362
5.3.1.2 Rightward Default: Aguacatec	366
5.3.1.3 Western Cheremis	370
5.3.1.4 Latin	373
5.3.1.5 Summary	383
5.3.2 Defaults to Opposite Side	383
5.3.2.1 Constraint Interactions	389
5.3.2.2 Rightward Default: Kwakwala	394
5.3.2.3 Leftward Default: Selkup	398
5.3.2.4 Classical Arabic	401
5.3 Summary	404
CONCLUSION	406
REFERENCES	409

INTRODUCTION

This proposal develops a set of assumptions that form the basis for a general account of metrical stress in Optimality Theory. The approach is based on the *Generalized Alignment* framework of McCarthy and Prince 1993b, so that some of what will be explored in the following pages is familiar. As alignment by itself, however, is not a comprehensive theory of stress, being only as successful as the theory's supporting assumptions, the proposed approach will make several crucial departures from the standard account.¹

To indicate at the outset the scale of the proposed departures, I will mention three in particular that challenge fundamental assumptions of the standard account. The first departure is to abandon weak layering. The theory will demand strict succession at all levels of the prosodic hierarchy, but it will be particularly crucial that the parsing of syllables into feet be universally exhaustive. The second departure is to abandon the insistence on proper bracketing. Categories on the same level of the prosodic hierarchy will be allowed to intersect:

(1) Intersecting Feet



In general terms, the intersecting configuration is one in which two prosodic categories of the same level share one (or more) of their immediate constituents, as the two feet in (1) share a syllable. The third departure is to relax the one-to-one correspondence between feet and stress. I will argue that it is necessary to allow feet to share a stress, as seen in the intersecting configuration of (2a) below, and that it is even necessary to allow feet to remain stressless, as seen in (2b) below.

¹ In discussing stress patterns as an example of alignment, McCarthy and Prince (1993b) utilize several background assumptions in rendering the illustration. Among these assumptions are a principle of exact foot binarity, the toleration of weak layering, a principle of proper bracketing, and a one-to-one correspondence between feet and stress. The first two are discussed, but not extensively. The third and fourth are discussed not at all, but implicitly assumed, as in most other work dealing with prosodic structure. As these assumptions have been adopted, in whole or in part, along with alignment, in most subsequent work, I will refer to this approach as the “standard account”.

(2) Shared Stress and Stressless

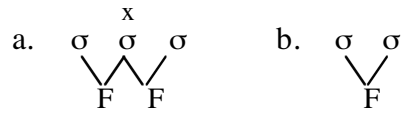

We will find that these assumptions, taken together with others to be encountered as we proceed, restrict the theory to a different and much smaller range of stress patterns than are possible under current approaches.

The presentation of the proposal proceeds as follows. In Chapter 1, I will first examine the typology predicted by the standard account, compare it with the actually attested typology, and highlight the areas in which the standard account falls short. I will then outline the core principles of the proposed account and indicate briefly how they will overcome the problems that the standard approach encounters. Chapter 2 examines in fuller detail three distinguishable systems within the theory: the prosodic hierarchy, prosodic prominence, and the metrical grid. First I will explore the conditions and constraints that determine the internal properties of these systems, and then the conditions and constraints that either restrict or facilitate interaction between them. Examples of the topics to be addressed in this chapter are binarity, proper and improper bracketing, headedness, and clash. In Chapter 3, I will examine alignment constraints for several types of structure— including prosodic categories, prosodic heads, and gridmark entries. The stress systems to be analyzed in this chapter include part of the binary alternation typology introduced in Chapter 1, weight-insensitive unbounded stress systems, and systems with ternary alternation.

Chapter 4 introduces a fourth system, the slope category system, to the grammar. Its primary function is to govern the minimal and maximal distances that can occur between gridmark entries and the edges of prosodic categories. In Chapter 4, I discuss three types of constraints based on the slope category system and examine how these constraints can ensure stress on certain initial elements of a domain, ban stress from certain final elements, or limit stress to windows at domain edges. The types of phenomena that I will analyze in these terms include the remainder of the typology established in Chapter 1, traditional Non-

Finality and extrametricality effects, stress windows, and trisyllabic shortening. Chapter 5 continues discussion of the slope category system, shifting focus to the system's role in producing weight-sensitivity. The types of phenomena that will be accounted for include quantity sensitivity, obligatory branching, iambic lengthening, and trochaic lengthening. Particular attention will be given to weight-sensitive unbounded stress systems.

CHAPTER ONE

ODD SYLLABLES AND ASYMMETRIES

Given an approach based on binary footing, much of the theory of metrical stress reduces to a theory of how to treat the odd, leftover syllable of odd-parity forms. Once binary feet become the standard, there is little that the theory needs to say about even-parity forms, aside from specifying the type of foot, iambic or trochaic, used in parsing:

(1) Parsing Even-Parity Forms

a. Trochaic

$$\begin{array}{c} x \quad x \quad x \\ (\sigma \sigma)(\sigma \sigma)(\sigma \sigma) \end{array}$$

b. Iambic

$$\begin{array}{c} x \quad x \quad x \\ (\sigma \sigma)(\sigma \sigma)(\sigma \sigma) \end{array}$$

Even-parity forms, as (1) demonstrates, can be exhaustively parsed into binary feet. Since there are no odd syllables, the question of how they should be footed (or not footed) does not arise. Also due to the lack of odd syllables is the absence of parsing directionality effects. It is impossible to determine whether the footing begins at the left edge in the forms above or at the right edge, as the result would be the same from either direction. The only difference between the two forms is that the (a) feet are trochaic and the (b) feet are iambic.

Most variation between metrical stress systems occurs in their odd-parity forms, which cannot, under standard assumptions, be exhaustively parsed into binary feet:

(2) Parsing Odd-Parity Forms

a. Non-Footing

$$(\sigma \sigma)(\sigma \sigma)(\sigma \sigma)\sigma$$

b. Monosyllabic Foot

$$(\sigma \sigma)(\sigma \sigma)(\sigma \sigma)(\sigma)$$

Arising in these forms is the issue of whether to leave the odd syllable unfooted, as in (2a), to parse it as a degenerate foot, as in (2b), or to treat it in some other fashion. Also arising is the issue of where to position the leftover syllable:

(3) Position of the Odd Syllable

a. Leftmost

$$\begin{array}{c} \sigma (\sigma \sigma)(\sigma \sigma)(\sigma \sigma) \\ (\sigma)(\sigma \sigma)(\sigma \sigma)(\sigma \sigma) \end{array}$$

b. Rightmost

$$\begin{array}{c} (\sigma \sigma)(\sigma \sigma)(\sigma \sigma)\sigma \\ (\sigma \sigma)(\sigma \sigma)(\sigma \sigma)(\sigma) \end{array}$$

The odd syllable might be to the left of the binary feet, as in (3a), to the right of the binary feet, as in (3b), or somewhere in between.

Both the structural realization of the odd syllable and the position it occupies have a substantial impact on the resulting stress pattern. The location of a monosyllabic foot is standardly a stressed position, and the location of an unfooted syllable is standardly an unstressed position. Varying the location of these different types in relation to iambs and trochees produces a large number of different possible patterns. Although there are numerous complexities, including the influence of syllable weight, morphological boundaries, and Nonfinality, I will initially set these factors aside and focus on the problems of simple directionality.

1.1 The Standard Account

Since the decisions made by a theory of metrical stress are largely decisions about what to do with leftover syllables, the theory's assumptions in this regard will be pivotal in determining its success or failure. Currently, the standard approach is one where the theory allows two possible structural realizations. Either the odd syllable remains unfooted or it is parsed as a monosyllabic foot, the options illustrated in (2). The standard account makes these options available through the violability of a constraint like Parse-Syll (McCarthy and Prince 1993b), "all syllables are parsed into feet", and the violability of a constraint like Ft-Bin (McCarthy and Prince 1993b), "all feet are binary". If Ft-Bin ranks above Parse-Syll, odd syllables are left unfooted, but if Parse-Syll ranks above Ft-Bin, odd syllables are parsed as degenerate feet.¹

¹ At least, this is apparently the desired effect of the ranking. The standard formulation of the Ft-Bin constraint actually leads to the harmonic bounding of forms with monosyllabic feet by forms with ternary feet. In competition between a candidate with a monosyllabic foot and a candidate with a ternary foot, both of which deviate from Ft-Bin to the same degree, ternary feet will always be preferred by alignment constraints over monosyllabic feet.

The position of the odd syllable is determined by foot alignment constraints,² constraints that are symmetrical by definition, being freely available with either leftward or rightward directional specifications. An unfooted syllable or degenerate foot can occur to the left or right in a form depending on alignment directionality. As Crowhurst and Hewitt (1995) demonstrate, however, the two types react differently to directional specifications. Unfooted syllables occur at the edge opposite the direction of foot alignment, as (4a) illustrates, and degenerate feet occur at the same edge as the direction of foot alignment, as (4b) illustrates:

(4) Effects of Alignment on Odd Syllables

	Align (Ft, L, PrWd, L)	Align (Ft, R, PrWd, R)
a. Unfooted	(σ σ)(σ σ)(σ σ) σ	σ (σ σ)(σ σ)(σ σ)
b. Footed	(σ)(σ σ)(σ σ)(σ σ)	(σ σ)(σ σ)(σ σ)(σ)

In other words, leftward foot alignment places unfooted syllables at the right edge but places degenerate feet at the left edge. Rightward foot alignment places unfooted syllables at the left edge but places degenerate feet at the right edge.

Another option would have an unfooted syllable (but not a monosyllabic foot³) in an intermediate position. As McCarthy and Prince 1993b demonstrates, this is accomplished by aligning one edge of a prosodic word with a single foot and aligning all remaining feet in the opposite direction:

(5) Conflicting Directionality

a. Align (PrWd, L, Ft, L) >> Align (Ft, R, PrWd, R) (σ σ) σ (σ σ)(σ σ)	b. Align (PrWd, R, Ft, R) >> Align (Ft, L, PrWd, L) (σ σ)(σ σ) σ (σ σ)
--	--

² Familiarity with the *Generalized Alignment* framework and the properties of alignment constraints— quantificational properties, symmetrical directionality, gradient violability— as outlined in McCarthy and Prince 1993b is assumed in the discussion that follows.

³ Both edges of a prosodic word will always be aligned with a foot in forms with exhaustive parsing, so prosodic word alignment can have no effect on the relative positions of disyllabic and monosyllabic feet, leaving foot alignment to determine these positions. The effects of conflicting prosodic word and foot alignment, therefore, are only exhibited in forms with partial parsing, where the alignment of the prosodic word is not assured.

In (5a), the left edge of the prosodic word is aligned with a single foot and all remaining feet are aligned toward the right edge. The unfooted syllable occurs immediately after the initial foot. In (5b), the right edge of the prosodic word is aligned with a single foot and all remaining feet are aligned toward the left edge. The unfooted syllable occurs immediately prior to the final foot.

Given the standardly assumed one-to-one correspondence between feet and stress, their ability to position leftover syllables gives foot alignment constraints substantial control over surface stress patterns. In theories where foot alignment directionality is independent of the determination of foot-type, also standardly assumed, each of the foot patterns produced by alignment will be available in both iambic and trochaic versions. If alignment can position an unfooted syllable at the left edge of an odd-parity form in trochaic systems, then it can position an unfooted syllable at the left edge of an odd-parity form in iambic systems, and if alignment can position a degenerate foot at the right edge of an odd-parity form in trochaic systems, then it can position a degenerate foot at the right edge of an odd-parity form in iambic systems. In other words, the standard account predicts that every foot pattern that occurs with trochees will occur with iambs as well, and every foot pattern that occurs with iambs will occur with trochees as well.

The twelve basic stress patterns predicted by the standard approach, then, can be demonstrated by combining the six foot patterns in (4) and (5) with both iambic and trochaic foot-types. The examples in (6) illustrate the four predicted odd-parity patterns involving unfooted syllables with simple alignment.

(6) Stress Patterns with Unfooted Syllables

a. Leftward Alignment
with Trochees

x x x
(σσ)(σσ)(σσ)σ

b. Rightward Alignment
with Trochees

x x x
σ(σσ)(σσ)(σσ)

c. Leftward Alignment
with Iambs

x x x
(σσ)(σσ)(σσ)

d. Rightward Alignment
with Iambs

x x x
σ(σσ)(σσ)(σσ)

Notice that aligning trochees leftward, as illustrated in (a), produces a gridmark pattern that is the mirror image of that produced by aligning iambs rightward, as illustrated in (d). In (a), every odd-numbered syllable is stressed except the final, and in (d), every odd-numbered syllable is stressed except the initial. Likewise, aligning trochees rightward, as illustrated in (b), produces a gridmark pattern that is the mirror image of that produced by aligning iambs leftward, as illustrated in (c). In both (b) and (c), every even-numbered syllable is stressed.

The examples in (7) illustrate the four predicted odd-parity patterns involving degenerate feet.

(7) Stress Patterns with Monosyllabic Feet

a. Leftward Alignment
with Trochees

x x x x
(σ)(σσ)(σσ)(σσ)

b. Rightward Alignment
with Trochees

x x x x
(σσ)(σσ)(σσ)(σ)

c. Leftward Alignment
with Iambs

x x x x
(σ)(σσ)(σσ)(σσ)

d. Rightward Alignment
with Iambs

x x x x
(σσ)(σσ)(σσ)(σ)

The leftward alignment of trochees in (a) again produces a gridmark pattern that is the mirror image of that produced by the rightward alignment of iambs in (d). In (a), every even-numbered syllable and the initial syllable are stressed, and in (d), every even-numbered syllable and the final syllable are stressed. Likewise, the rightward alignment of trochees in (b) produces a gridmark pattern that is the mirror image of that produced by the leftward alignment of iambs in (c). In both (b) and (c), every odd-numbered syllable is stressed.

Finally, the examples in (8) illustrate the four predicted odd-parity patterns involving conflicting alignment.

(8) Stress Patterns with Conflicting Directionality

a. Final Foot and
Leftward Alignment
with Trochees

x x x
(σ σ)(σ σ) σ (σ σ)

b. Initial Foot and
Rightward Alignment
with Trochees

x x x
(σ σ) σ (σ σ)(σ σ)

c. Final Foot and
Leftward Alignment
with Iambs

x x x
(σ σ)(σ σ) σ (σ σ)

d. Initial Foot and
Rightward Alignment
with Iambs

x x x
(σ σ) σ (σ σ)(σ σ)

In trochaic systems, aligning the right edge of the prosodic word with a single foot and aligning all remaining feet to the left, as illustrated in (a), produces a gridmark pattern that is the mirror image of that produced in iambic systems by aligning the left edge of the prosodic word with a single foot and aligning all remaining feet to the right, as illustrated in (d). In (a), stress occurs on the penult and every odd-numbered syllable except the antepenult, and in (d), stress occurs on the peninitial syllable and every odd-numbered syllable except the post-peninitial syllable. In trochaic systems, aligning the left edge of the prosodic word with a single foot and aligning all remaining feet to the right, as illustrated in (b), produces a gridmark pattern that is the mirror image of that produced in iambic systems by aligning the right edge of the prosodic word with a single foot and aligning all remaining feet to the left, as illustrated in (c). In (b), stress occurs on the initial syllable and every even-numbered syllable except the peninitial, and in (c), stress occurs on the ultima and every even-numbered syllable except the penult.

When we match the odd-parity patterns of (6-8) to their appropriate even-parity patterns, we get the types of alternations summarized in (9) below. In (9), the patterns are organized in pairs based on iambic and trochaic mirror images, rather than on the types of alignment that produce them. The first two types, minimal and maximal alternation, are the

patterns conforming to Prince's (1983) Perfect Grid. They exhibit strict binary alternation, containing neither clash configurations nor lapse of entries. The difference between the two types is that minimal alternation has the fewest entries possible while still conforming to the Perfect Grid, and maximal alternation has the most entries possible while still conforming to the Perfect Grid. The distinguishing characteristic of the double offbeat type is the two adjacent stressless syllables that occur at one edge or the other in odd-parity forms, at the right edge in the trochaic pattern and at the left edge in the iambic pattern. In the internal ternary type, the pair of stressless syllables moves inward, occurring prior to the penult in the trochaic pattern and after the peninitial syllable in the iambic pattern. The distinguishing characteristic of the double downbeat type is the pair of adjacent stressed syllables that occur at one edge or the other in odd-parity forms, at the left edge in the trochaic pattern and at the right edge in the iambic pattern. Finally, the distinguishing characteristic of the edge ternary type, like the double offbeat and internal ternary types, involves a pair of adjacent stressless syllables; however, in this case the pair occurs after the initial syllable in the trochaic pattern and prior to the ultima in the iambic pattern.

(9) Predicted Typology

Minimal Alternation

x x x	x x x
(σ σ)(σ σ)(σ σ)	(σ σ)(σ σ)(σ σ)
x x x	x x x
σ (σ σ)(σ σ)(σ σ)	(σ σ)(σ σ)(σ σ) σ

Maximal Alternation

x x x	x x x
(σ σ)(σ σ)(σ σ)	(σ σ)(σ σ)(σ σ)
x x x x	x x x x
(σ σ)(σ σ)(σ σ)(σ)	(σ)(σ σ)(σ σ)(σ σ)

Double Offbeat

x x x	x x x
(σ σ)(σ σ)(σ σ)	(σ σ)(σ σ)(σ σ)
x x x	x x x
(σ σ)(σ σ)(σ σ) σ	σ (σ σ)(σ σ)(σ σ)

Internal Ternary

x x x	x x x
(σ σ)(σ σ)(σ σ)	(σ σ)(σ σ)(σ σ)
x x x	x x x
(σ σ)(σ σ) σ (σ σ)	(σ σ) σ (σ σ)(σ σ)

Double Downbeat

x x x	x x x
(σ σ)(σ σ)(σ σ)	(σ σ)(σ σ)(σ σ)
x x x x	x x x x
(σ)(σ σ)(σ σ)(σ σ)	(σ σ)(σ σ)(σ σ)(σ)

Edge Ternary

x x x	x x x
(σ σ)(σ σ)(σ σ)	(σ σ)(σ σ)(σ σ)
x x x	x x x
(σ σ) σ (σ σ)(σ σ)	(σ σ)(σ σ) σ (σ σ)

As (9) demonstrates, the typology predicted by the standard account is perfectly symmetrical. Every trochaic pattern in the column on the left has a mirror image iambic pattern in the column on the right. The empirical realities, however, seem to be much different.

Although it is well known that iambic systems do not exhibit the same range of directional footing options as trochaic systems (for discussion, see Kager 1993 and Hayes

1995), it is important to be clear about where the differences lie. Based on the survey in Hayes 1995, as well as my own investigation, the attested typology of metrical stress systems corresponding to that predicted by the standard account appears to be as given in (10) and (11). Table (10) shows the types where the trochaic version has an attested mirror image iambic version, and (11) shows the types where the trochaic version does not have an attested mirror image iambic version. With each of the attested patterns, I have listed one or more example languages.

(10) Symmetrically Attested Patterns

Minimal Alternation

x x x
σ σ σ σ σ σ

x x x
σ σ σ σ σ σ

x x x
σ σ σ σ σ σ

x x x
σ σ σ σ σ σ

Cavinena (Key 1968)
Nengone (Tryon 1967)
Warao (Osborn 1966)
Yakan (Behrens 1975)

Araucanian
(Echeverria and Contreras 1965)

Maximal Alternation

x x x
σ σ σ σ σ σ

x x x
σ σ σ σ σ σ

x x x x
σ σ σ σ σ σ

x x x x
σ σ σ σ σ σ

Icelandic (Arnason 1980, 1985)
Maranungku (Tryon 1970)
Ningil (Manning and Sagers 1977)

Suruwaha (Everett 1996)
Weri (Boxwell and Boxwell 1966)

(11) Asymmetrically Attested Patterns

Double Offbeat

x x x
σ σ σ σ σ σ

x x x
σ σ σ σ σ σ

x x x
σ σ σ σ σ σ σ

x x x
σ σ σ σ σ σ σ

Pintupi (Hansen and Hansen 1969)
Wangkumara
(McDonald and Wurm 1979)

Unattested

Internal Ternary

x x x
σ σ σ σ σ σ

x x x
σ σ σ σ σ σ

x x x
σ σ σ σ σ σ σ

x x x
σ σ σ σ σ σ σ

Piro (Matteson 1965)
Polish (Rubach and Booij 1985)

Unattested

Double Downbeat

x x x
σ σ σ σ σ σ

x x x
σ σ σ σ σ σ

x x x x
σ σ σ σ σ σ σ

x x x x
σ σ σ σ σ σ σ

Maithili (Jha 1940-1944, 1958)
Passamaquoddy (LeSourd 1993)

Unattested

Edge Ternary

x x x
σ σ σ σ σ σ

x x x
σ σ σ σ σ σ

x x x
σ σ σ σ σ σ σ

x x x
σ σ σ σ σ σ σ

Garawa (Furby 1974)
Indonesian (Cohn 1989)

Unattested

A comparison between the tables in (9) and (10, 11), demonstrates where the standard account's symmetrical typology is incorrect. Of the twelve patterns predicted, only eight are actually attested. The missing patterns are the four iambic patterns of (11), which, when considered in terms of the standard approach, are the left-aligned pattern where degenerate feet are not allowed, the right-aligned pattern where they are, and both patterns with complex alignment.

Overall, the distribution can be summarized in terms of the Perfect Grid. The patterns which conform to the Perfect Grid— minimal and maximal alternation— are symmetrically attested, occurring in both their trochaic and iambic versions. The patterns which do not conform to the Perfect Grid— double offbeat, double downbeat, internal ternary, and edge ternary— are asymmetrically attested, occurring only in their trochaic versions.

1.2 Two Observations

Uncovering possible explanations for the distribution of the patterns in (10, 11) will be one of the proposal’s central tasks. The structures that the standard account posits, however, tend to obscure the connections between patterns that would help bring these explanations to light, so before outlining the proposed assumptions and their implementation, it will be helpful first to make some observations concerning the standard structures. Consider, for example, the foot pattern in (12), the pattern for the odd-parity forms of both trochaic minimal alternation (attested) and the iambic double offbeat pattern (unattested).

(12) Footing of Trochaic Minimal Alternation and Iambic Double Upbeat

$$\sigma (\sigma \sigma) (\sigma \sigma) (\sigma \sigma)$$

Although the footing itself is easily obtained under the standard approach (being a simple case of rightward foot alignment with an unfooted syllable) the pattern is actually available only to trochaic systems and not to iambic systems. Several other similar comparisons— rightward alignment with a degenerate foot and conflicting alignment— are possible.

Two different conclusions might be reached here. First, foot patterns are not so independently determined as the standard account would lead us to believe. Under the standard approach, it is possible to position feet solely on the basis of alignment directionality. In actuality, however, the availability of certain foot patterns seems to depend on the type of foot involved. The second conclusion would take an opposite perspective— that the foot-types are not as independently determined as the standard account would lead us to believe. Restrictions on foot-type cannot be explained either by a symmetrical inventory of possible

feet, a parameter of left or right-headedness, or opposing left-headed and right-headed constraints. The attested typology would lead us to believe, rather, that there are more ways to obtain a trochaic foot-type than there are to obtain an iambic foot-type. The proposed account will take the view that both conclusions are correct in the sense that foot-type is connected to alignment directionality but that there are actually more ways to obtain trochees than iambs.

A second observation concerning the standard structures is that there are so many differences between them. The standard approach offers more structural distinction than is necessary to determine the differences in stress patterns. All that is needed to denote the presence or absence of stress is the presence or absence of an appropriate gridmark entry, but in the standard account, odd syllables that are stressless must also be unfooted. If we were to reconsider the absolute correspondence between feet and stress, however, we might parse both the trochaic minimal alternation pattern of (10) and the double downbeat pattern of (11), for example, with the footing in (13), where exhaustive parsing holds and odd syllables are sometimes stressless but not unfooted.

(13) Stressless Feet

a. Minimal Alternation

$$\begin{array}{c} x \quad x \quad x \\ (\sigma)(\sigma\sigma)(\sigma\sigma)(\sigma\sigma) \end{array}$$

b. Double Downbeat

$$\begin{array}{c} x \quad x \quad x \quad x \\ (\sigma)(\sigma\sigma)(\sigma\sigma)(\sigma\sigma) \end{array}$$

A similar contrast can be made between the odd-parity forms of the maximal alternation and double offbeat patterns. The conclusion to be reached here is that rethinking our assumptions about the relationship between feet and stress may allow the theory to have exhaustive parsing and decrease the structural dissimilarities between forms, making the stressed-unstressed distinction closer to the one that is minimally necessary.

1.3 The Proposal

Against the background of these observations, we can begin to introduce the proposed account's basic components. The theory proposed here, like the standard theory, is based on alignment, but it differs from the standard account in limiting the patterns that alignment can produce symmetrically. In the above paragraphs, I mentioned three assumptions that I consider to be standard in current approaches: the independent specification of foot-type and foot alignment directionality, the limitation of the structural options for odd syllables to non-parsing and parsing as monosyllabic feet, and the one-to-one correspondence between feet and stress. The proposed account will deny all three.

The format of this introduction is not to lay out the theory's components all at once, but to outline some of the consequences and motivations of the individual principles as we proceed step by step through an examination of the attested typology. I will take each pattern one at a time, beginning with the symmetrically attested patterns, minimal and maximal alternation. I consider minimal and maximal alternation, in a sense, to be the proposal's core patterns, with the remaining patterns being variations on these two core types. The strategy is to establish a high degree of restrictiveness at the outset and then to gradually relax these limitations. Initially, I will place such restrictions on the theory of alignment and its supporting mechanisms that the grammar will be able to produce the minimal alternation patterns and only the minimal alternation patterns. Then I will loosen these restrictions so that the maximal alternation patterns, but only the maximal alternation patterns, will be added. The restrictions will then be further loosened to obtain the trochaic double offbeat pattern, and so on through the typology.

1.3.1 Minimal Alternation

The minimal alternation patterns, which exhibit strict alternation of stress but with the fewest possible stressed syllables, are repeated in (14) below. These form the first of the typology's two symmetrically attested types.

(14) Minimal Alternation

a. Trochaic (Attested)

$$\begin{array}{cccccc} x & & x & & x & \\ \sigma & \sigma & \sigma & \sigma & \sigma & \sigma \end{array}$$

$$\begin{array}{cccccc} x & & x & & x & \\ \sigma & \sigma & \sigma & \sigma & \sigma & \sigma \end{array}$$

b. Iambic (Attested)

$$\begin{array}{cccccc} & x & & x & & x \\ \sigma & \sigma & \sigma & \sigma & \sigma & \sigma \end{array}$$

$$\begin{array}{cccccc} & x & & x & & x \\ \sigma & \sigma & \sigma & \sigma & \sigma & \sigma \end{array}$$

Minimal alternation is illustrated in (15) using Warao (Osborn 1966) for trochaic systems and in (16) using Araucanian (Echeverria and Contreras 1965) for iambic systems.

(15) Warao

Even	yàpurùkitàneháse	<i>verily to climb</i>
Odd	enàhoròahàkutái	<i>the one who caused him to eat</i>

(16) Araucanian

Even	elúmuyù	<i>give us</i>
Odd	elúaènew	<i>he will give me</i>

The goal in this part of the discussion is to develop an alignment-based theory that is restricted to exactly the minimal alternation patterns.

The first two steps toward this goal limit the theory to two patterns, one iambic and one trochaic. They are eliminating the possibility of weak layering with a non-violable demand for strict succession (see Selkirk 1984, Nespor and Voegel 1986, and Ito and Mester 1992 for background and discussion) and exchanging foot alignment for foot-head alignment (see Green 1993 for a precedent). Two additional steps transform the patterns obtained by the above restrictions into the minimal alternation patterns. They are reformulating the correspondence between feet and stress (see Hayes 1987, Tyhurst 1987, Hung 1993, 1994, and Crowhurst 1996 for precedents) and introducing the possibility of improper

bracketing (see Liberman 1975, Selkirk 1984, Nespor and Voegel 1986, Ito and Mester 1992, and Kenstowicz 1995 for background and discussion).

1.3.1.1 Strict Succession

The first move away from the standard approach is to demand strict succession between prosodic categories. The proposal will remove Parse-Syll from the grammar as a violable constraint and replace it as a non-violable condition on Gen. Making Parse-Syll non-violable, limits the theory to the following two foot patterns (setting aside the possibility of ternary and unbounded feet): one exhibiting leftward foot alignment and one exhibiting rightward foot alignment. In either case, the odd syllable of odd-parity forms is footed:

(17) Footing Options under Strict Succession

- | | |
|----------------------------|----------------------------|
| a. Leftward Alignment | b. Rightward Alignment |
| (σ σ)(σ σ)(σ σ) | (σ σ)(σ σ)(σ σ) |
| (σ)(σ σ)(σ σ)(σ σ) | (σ σ)(σ σ)(σ σ)(σ) |

With each of the foot patterns in (17) being available in both iambic and trochaic versions, the theory at this stage is able to produce, but is also limited to, the four stress patterns below:

(18) Stress Patterns under Strict Succession

- | | |
|--|--|
| a. Leftward Alignment
with Trochees | b. Rightward Alignment
with Trochees |
| x x x
(σ σ)(σ σ)(σ σ) | x x x
(σ σ)(σ σ)(σ σ) |
| x x x x
(σ)(σ σ)(σ σ)(σ σ) | x x x x
(σ σ)(σ σ)(σ σ)(σ) |
| c. Leftward Alignment
with Iambs | d. Rightward Alignment
with Iambs |
| x x x
(σ σ)(σ σ)(σ σ) | x x x
(σ σ)(σ σ)(σ σ) |
| x x x x
(σ)(σ σ)(σ σ)(σ σ) | x x x x
(σ σ)(σ σ)(σ σ)(σ) |

In (18), every form exhibits exhaustive parsing, as demanded by Strict Succession. Examples (a, b) are trochaic patterns, (a) exhibiting leftward alignment and (b) exhibiting right-

ward alignment. Examples (c, d) are iambic patterns, (c) exhibiting leftward alignment and (d) exhibiting rightward alignment.

1.3.1.2 Foot-Head Alignment

Recall the observation above that foot-type and parsing directionality cannot be so independent as the standard account might lead us to believe. In demonstrating how the proposed approach limits the independence of these variables it is useful to make an observation concerning the examples in (18). I described these examples above in terms of independently specified foot-types and directions of alignment. There were two types of feet, trochees and iambs, and two types of alignment, left and right. Trochees could be left-aligned or right-aligned, and iambs could be left-aligned or right-aligned.

A second way to think about these specifications is in terms of agreement and conflict. There are two patterns where the head's position within the foot matches the direction of alignment: left-aligned, left-headed feet, as in (18a), and right-aligned, right-headed feet, as in (18d). There are also two patterns where the head's position within the foot is opposite the direction of alignment: right-aligned, left-headed feet, as in (18b), and left-aligned, right-headed feet, as in (18c). Although the conflict-agreement view of foot-type and alignment offers no practical difference when considering the patterns in (18), it does offer the general possibility of establishing dependencies between the position of the head within the foot and alignment directionality. In the proposed account, agreement and conflict between foot-type and alignment will be an important theme. Agreement will be considered the “default” case in the sense that this will be the situation preferred by the alignment constraints the theory is based on. Introducing conflict in various ways, especially in ways that prefer trochaic feet over iambic feet, will be crucial in obtaining key asymmetrically attested patterns.

The second move away from the standard approach, then, is to change the referents of alignment constraints so that the type of foot— iambic or trochaic— can be specified simultaneously with foot alignment directionality. In other words, we want to create an imme-

diate connection between the head’s position within the foot and the directionality of foot alignment. A straightforward way to accomplish this is through constraints aligning the heads of feet within prosodic words, and the proposed account, therefore, replaces the standard Align (Ft, PrWd) constraints with the following Align (Ft-Hd, PrWd) constraints:

(19) Foot-Head Alignment Constraints

Hds-Right or Align (Ft-Hd, R, PrWd, R): The right edge of every foot-head is aligned with the right edge of some prosodic word.

Hds-Left or Align (Ft-Hd, L, PrWd, L): The left edge of every foot-head is aligned with the left edge of some prosodic word.

Foot-head alignment constraints, in many respects, have the same effects as foot alignment constraints. For example, they influence the position of feet within a prosodic word:

(20) Position of the Foot

a. Hds-Left

b. Hds-Right

x
(σ σ) σ σ σ σ

σ σ σ σ (σ σ)
x

In (20a), an example of optimal leftward foot-head alignment, the foot occurs at the left edge of the prosodic word, and in (20b), an example of optimal rightward foot-head alignment, the foot occurs at the right edge of the prosodic word. Since the head of a foot must be inside the foot, the foot-head will drag the boundary of the foot with it towards the designated edge. Unlike the Align Ft constraints, however, the Align Ft-Hd constraints also influence the head’s position within the foot. In (20a), leftward foot-head alignment produces a trochee at the left edge of the prosodic word, and in (20b), rightward foot-head alignment produces an iamb at the right edge. If the head were moved rightward within the foot in (20a)— if the foot were an iamb instead of a trochee— then it would be misaligned and would result in a violation of Hds-Left. If the head were moved leftward within the foot in (20b)— if the foot were a trochee instead of an iamb— then it would be misaligned and result in a violation of Hds-Right.

The latter phenomenon is even more clearly visible in exhaustively parsed even-parity forms, where footing directionality is not evident, but foot-head alignment still determines the head's position within the foot:

(21) Position of the Head within the Foot

a. Hds-Left

$$\begin{array}{c} x \quad x \quad x \\ (\sigma \sigma)(\sigma \sigma)(\sigma \sigma) \end{array}$$

b. Hds-Right

$$\begin{array}{c} x \quad x \quad x \\ (\sigma \sigma)(\sigma \sigma)(\sigma \sigma) \end{array}$$

By forcing heads of feet to the right or left within the prosodic word, foot-head alignment also force the heads to be right or left within the foot itself. In (21a), demonstrating the leftward alignment of foot-heads within the prosodic word, the feet are trochaic, but in (21b), demonstrating the rightward alignment of foot-heads within the prosodic word, the feet are iambic.

With the substitution of Align Ft-Hd constraints for Align Ft constraints, we have now limited the theory to the patterns from (18) where the head's position within the foot matches the direction of alignment. These patterns are repeated in (22), where the trochees of (a) exhibit leftward foot alignment, and the iambs of (b) exhibit rightward foot alignment.

(22) Matching Head Position and Foot Alignment

a. Hds-Left

$$\begin{array}{c} x \quad x \quad x \\ (\sigma \sigma)(\sigma \sigma)(\sigma \sigma) \end{array}$$

$$\begin{array}{c} x \quad x \quad x \quad x \\ (\sigma)(\sigma \sigma)(\sigma \sigma)(\sigma \sigma) \end{array}$$

b. Hds-Right

$$\begin{array}{c} x \quad x \quad x \\ (\sigma \sigma)(\sigma \sigma)(\sigma \sigma) \end{array}$$

$$\begin{array}{c} x \quad x \quad x \quad x \\ (\sigma \sigma)(\sigma \sigma)(\sigma \sigma)(\sigma) \end{array}$$

The next task is to associate the foot patterns of (22) with the stress patterns of minimal alternation. In the standard account, the minimal alternation patterns were obtained using partial parsing, so that odd syllables would remain unfooted and stressless. This approach is clearly not possible in the proposed account given the insistence on strict succession. As we saw in the second observation of Section 1.2 above, however, it may be possible to obtain the stress patterns of partial parsing with the foot patterns of exhaustive parsing.

1.3.1.3 Feet and Stress

Obtaining the stress patterns of partial parsing with the foot patterns of exhaustive parsing might seem to require just two components. The first is a modification of the theory that will allow feet to be stressless. This can be accomplished in Optimality Theory simply by making the relation between feet and gridmarks violable, as in the constraint in (23).

(23) MapGridmark

Each foot corresponds to a foot-level gridmark

The MapGridmark constraint governs the relationship between feet and the metrical grid. It demands that all feet have foot-level gridmarks, but since it is violable, this demand may not always be met.

Having formulated the constraint in this way, it is crucial that the theory separate the notion of *head* from that of *gridmark*. The head of the foot is the foot's most prominent syllable, but a syllable being given the designation "head" does not necessarily mean that it will be stressed through association with a gridmark entry. The importance of this separation with respect to the violability of MapGridmark is that output candidates can have stressless— but not headless— feet, a situation that has crucial implications for foot-head alignment. Align Ft-Hd refers to heads of feet and not to the gridmarks that may be associated with them. The fact that a foot lacks a gridmark does not mean that it lacks a head and is, therefore, not subject to foot-head alignment constraints. The separation of heads from gridmarks will also have implications for other aspects of the proposal. For example, the split makes it necessary to decide whether standard principles like clash avoidance, lapse avoidance, and Weight to Stress refer to gridmarks or to heads. As we shall see below and in the next chapter, clash will refer to gridmarks, and lapse and Weight to Stress will refer to heads.

The second component to the analysis is a mechanism that can cause feet to be stressless by forcing MapGridmark to be violated. One such mechanism is clash avoidance

(see Liberman and Prince 1977 and Prince 1983 for discussion), incorporated into the violable constraint below:

(24) *Clash (adapted from Prince 1983)

For any two gridmark entries on level n ($n \neq 0$) there is an intervening entry on level $n - 1$.

When two adjacent feet occur in a configuration where their gridmarks would be in clash, a highly ranked *Clash constraint can prevent one of the feet from associating with a gridmark. This allows the theory to obtain the desired minimal alternation patterns with the configurations in (25). (Base level gridmarks are not shown.)

(25) Minimal Alternation from Clash Avoidance

a. Hds-Left

$$\begin{array}{c} x \quad x \quad x \\ (\sigma \sigma)(\sigma \sigma)(\sigma \sigma) \\ \\ x \quad x \quad x \\ (\sigma)(\sigma \sigma)(\sigma \sigma)(\sigma \sigma) \end{array}$$

b. Hds-Right

$$\begin{array}{c} x \quad x \quad x \\ (\sigma \sigma)(\sigma \sigma)(\sigma \sigma) \\ \\ x \quad x \quad x \\ (\sigma \sigma)(\sigma \sigma)(\sigma \sigma)(\sigma) \end{array}$$

In (25), exhaustive parsing obtains the stress pattern of minimal alternation by allowing the degenerate foot to remain stressless. Since the *Clash constraint is highly ranked, and since stressing the degenerate foot would result in clash, leaving a gridmark off the degenerate foot is an option for clash avoidance.

Simple as this approach would be, it is not quite adequate for two reasons. First, *Clash and MapGridmark are both constraints and freely rerankable. If *Clash does not rank highly enough— if it does not rank above MapGridmark— all feet will retain their gridmarks, meaning that the theory would also symmetrically predict the asymmetrically attested double downbeat pattern. In other words, the forms of (22) are still with us, and we have not really transformed them into the minimal alternation pattern. Second, leaving a gridmark off the degenerate foot is not the only option for avoiding clash. Leaving a gridmark off the foot adjacent to the degenerate foot, as in (26), would also suffice.

(26) Edge Ternary Patterns from Clash Avoidance

a. Hds-Left

$$\begin{array}{c} x \quad x \quad x \\ (\sigma\sigma)(\sigma\sigma)(\sigma\sigma) \\ x \quad x \quad x \\ (\sigma)(\sigma\sigma)(\sigma\sigma)(\sigma\sigma) \end{array}$$

b. Hds-Right

$$\begin{array}{c} x \quad x \quad x \\ (\sigma\sigma)(\sigma\sigma)(\sigma\sigma) \\ x \quad x \quad x \\ (\sigma\sigma)(\sigma\sigma)(\sigma\sigma)(\sigma) \end{array}$$

The theory thus symmetrically predicts the asymmetrically attested edge ternary patterns as well.

The theory as it stands produces the minimal alternation pattern because the demands of *Clash and MapGridmark conflict in odd-parity forms, and the grammar can resolve this conflict in a way that obtains the desired configuration. The grammar can also resolve this conflict, however, in ways that make possible additional, undesired patterns. Although, as we shall see below, the violability of the foot-stress relationship must be maintained, another option for clash avoidance will be made available to the grammar.

The second option for clash avoidance is based on the possibility of allowing feet to share a gridmark. MapGridmark as reformulated in (27) below makes it clear that a one-to-one correspondence between feet and stress is not required. All that is required is that a foot-level gridmark occur somewhere within the domain of each foot.

(27) MapGridmark (Reformulated)

A foot-level gridmark is realized within the domain of every foot.

Notice that the reformulated MapGridmark does not demand that the part of the foot corresponding to the gridmark be the head of the foot. I will assume, however, that there is an inviolable condition working in the reverse direction that says that gridmarks must correspond to the heads of feet. I will develop this condition, the Gridmark-to-Head condition, more fully in Chapter 2.

1.3.1.4 Intersecting Feet

To take advantage of the reformulated MapGridmark constraint, it is necessary to abandon the assumption of proper bracketing. Feet must be allowed to intersect, as illustrated in (28).

(28) Intersecting Feet



The intersecting configuration is one where two categories of the same level share a constituent from the next level down, as the two feet in (28) share a syllable. If a gridmark occurs over the syllable in the intersection, as illustrated in (29), then both feet satisfy MapGridmark simultaneously.

(29) Gridmark Sharing

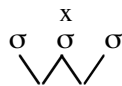

Both feet in the (29) configuration satisfy MapGridmark because the gridmark occurs within the intersection, meaning that the gridmark occurs within the domain of both feet.

The possibility of intersection provides the grammar with a second option for the treatment of the odd syllables in odd-parity forms. To see how this option helps to obtain the minimal alternation patterns while excluding others, it is helpful to examine it from a derivational standpoint. Say that we want to parse an odd-parity string of syllables using Right to Left trochaic iteration. Binary iteration takes us to the point illustrated in (30).

(30) Trochaic Right to Left Iteration

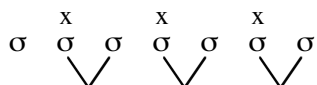

First, the seventh and sixth syllables are grouped together in a foot and a gridmark placed over the leftmost. The fifth and fourth are then grouped together, and the third and second, with a gridmark over the leftmost syllable of each foot. At this point, all that remains is the odd, leftover syllable. Given the assumption of strict succession, it must be parsed. If we parse it as a degenerate foot and associate it with a gridmark, a clash configuration will result, but if we parse it as a degenerate foot and do not associate it with a gridmark, then the foot-gridmark relationship will be violated.

Improper bracketing avoids both problems. The odd syllable is footed by extending the foot forward so that it includes a syllable of the adjacent foot:

(31) Clash Avoidance through Intersection

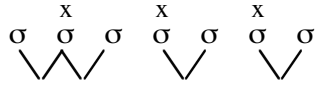

In (31), what would otherwise have been a degenerate foot is extended forward into the adjacent foot so that the two share a syllable. In sharing a syllable, the two feet also share the gridmark that occurs over this syllable. This allows the grammar to foot the odd syllable in a way that neither violates the foot-gridmark relationship nor results in clash.

In Optimality Theoretic terms, improper bracketing allows the grammar to produce an output candidate that harmonically bounds those where clash occurs or the foot-gridmark relationship is violated. This is demonstrated using odd-parity forms with leftward foot-head alignment in (32). (I utilize the notation of Hammond 1984 in this and the following examples. Vertical association lines denote head syllables, and slanting association lines denote non-head syllables.)

(32) Harmonic Bounding by Intersecting Configuration

	σσσσσσ	Hds-Left	MapGM	*Clash
a.	$\begin{array}{cccc} & x & & x & & x \\ \sigma & \sigma & \sigma & \sigma & \sigma & \sigma \\ & / & \backslash & / & \backslash & / \end{array}$	$\begin{array}{c} * \quad * * * \\ * * * * * \end{array}$		
b.	$\begin{array}{cccc} & x & & x & & x \\ \sigma & \sigma & \sigma & \sigma & \sigma & \sigma \\ & / & \backslash & / & \backslash & / \end{array}$	$\begin{array}{c} * \quad * * * \\ * * * * * \end{array}$	* !	
c.	$\begin{array}{cccc} x & & x & & x & \\ \sigma & \sigma & \sigma & \sigma & \sigma & \sigma \\ & / & \backslash & / & \backslash & / \end{array}$	$\begin{array}{c} * \quad * * * \\ * * * * * \end{array}$	* !	
d.	$\begin{array}{cccc} x & x & x & x \\ \sigma & \sigma & \sigma & \sigma & \sigma & \sigma \\ & / & \backslash & / & \backslash & / \end{array}$	$\begin{array}{c} * \quad * * * \\ * * * * * \end{array}$		* !

Notice that each of the candidates in (32) is exhaustively footed. They also all do equally well with respect to foot-head alignment, since the heads of feet occur in the same positions in each form. Candidate (a) represents the option of using intersected feet to parse the odd syllable. The syllable in the intersection occurs with a gridmark, meaning that a gridmark occurs within the domain of both feet and that both feet satisfy MapGridmark. The configuration also avoids clash, as there are no two gridmark entries that would not have an intervening entry one level down. Candidates (b, c) represent the option of parsing the odd syllable with a degenerate foot. Both avoid clash by leaving one foot stressless— the degenerate foot in candidate (b) and the foot adjacent to the degenerate foot in candidate (c). The absence of gridmarks, however, causes these feet to violate MapGridmark. Since candidate (a) fares as well on foot-head alignment and *Clash as candidates (b, c) but does better on MapGridmark, candidate (a) harmonically bounds (b, c). Candidate (d) represents the option of parsing the odd syllable with a degenerate foot and maintaining a unique stress for each foot to satisfy MapGridmark. The gridmarks of the degenerate and adjacent foot are in a clash configuration, however, and incur a violation of *Clash. Since candidate (a) fares as well on foot-head alignment and MapGridmark as candidate (d) but does better on *Clash, candidate (a) harmonically bounds (d). As the reasoning is much the same for the iambic mirror images produced by rightward foot-head alignment, I omit the additional tableau.

Tolerating improper bracketing, then, truly restricts the theory to two stress patterns, one iambic and one trochaic, and both corresponding to minimal alternation:

(33) Proposed Minimal Alternation Structures

a. Hds-Left

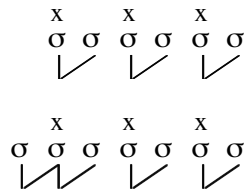

b. Hds-Right

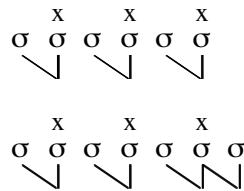

Given our current set of assumptions and constraints, all other configurations are either not possible as output candidates or are harmonically bounded by the structures in (33). We

have now obtained the high degree of restrictiveness that we sought as our initial target, and we can begin to loosen these restrictions so that other attested patterns will be added to the predicted typology.

1.3.2 Maximal Alternation

The maximal alternation patterns, which exhibit strict alternation of stress with the greatest possible number of stressed syllables, are repeated with their proposed structures in (34). They are the second of the two symmetrically attested types from the typology.

(34) Proposed Maximal Alternation Structures

a. Trochaic

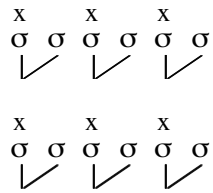

b. Iambic

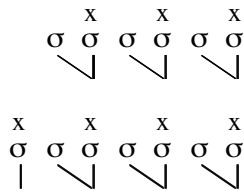

Maximal alternation is illustrated using Icelandic (Arnason 1980, 1985) in (35) for trochaic systems and using Weri (Boxwell and Boxwell 1966) in (36) for iambic systems.

(35) Icelandic

Even	rábbabàri	<i>rhubarb</i>
Odd	bíogràfià	<i>biography</i>

(36) Weri

Even	uľ̀amít	<i>mist</i>
Odd	àkunètepáľ	<i>times</i>

Under our current set of assumptions and constraints, these patterns are not obtainable, since they will always be outperformed by the minimal alternation structures of (33). Although none of the structures in (33) or (34) would have violations of *Clash or MapGrid-mark, one of the structures in (33) will always do better on foot-head alignment than the structures in (34). Under Strict Succession, the (33a) structure has the best leftward foot-head alignment possible given the length of the forms, and the (33b) structure has the best

rightward foot head alignment possible given the length of the forms. The structures of (34) have neither optimal leftward nor rightward foot-head alignment, and so there would be no basis under any ranking to choose the structures of (34) over those of (33).

Notice, however, that the structures posited for maximal alternation in (34), the same as those that would be posited in the standard approach, are such that the head's position within the foot conflicts with the direction of foot alignment. Trochees are aligned rightwardly, and iambs are aligned leftwardly. The maximal alternation patterns, then, can be reintroduced to the typology by producing, in a symmetrical fashion, conflict between the head's position within the foot and foot alignment directionality.

1.3.2.1 Prosodic Word Alignment

In the standard account, as discussed above, there are two possible alignment relationships between feet and prosodic words: alignment of feet with prosodic word edges and alignment of prosodic word edges with feet. A similar situation is possible for alignment relationships between foot-heads and prosodic words, meaning that the following two constraints are also available to the grammar:

(37) Prosodic Word Alignment Constraints

PrWd-R or Align (PrWd, R, Ft-Hd, R): The right edge of every prosodic word is aligned with the right edge of some foot-head.

PrWd-L or Align (PrWd, L, Ft-Hd, L): The left edge of every prosodic word is aligned with the left edge of some foot-head.

The existence of these constraints reintroduces conflicting directionality to the theory.

As we saw in Section 1.1 above, ranking an Align (PrWd, Ft) constraint over an Align (Ft, PrWd) constraint of the opposite directionality produces a situation in the standard account where one foot occurs at the edge of prosodic word alignment with all others being oriented in the direction of foot alignment. Similarly, ranking an Align (PrWd, Ft-Hd) constraint over an Align (Ft-Hd, PrWd) constraint of the opposite directionality produces a

configuration where one foot-head occurs at the edge of prosodic word alignment with all others being oriented toward the edge of foot-head alignment. This is illustrated in the even-parity forms below:

(38) Conflicting Directionality

a. PrWd- L >> Hds-Right

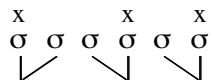

b. PrWd-R >> Hds-Left

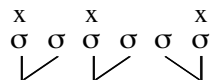

In (38a), the ranking PrWd-L >> Hds-Right produces a configuration where a trochee at the left edge is followed by a string of iambs. The foot at the left edge must be a trochee to satisfy leftward prosodic word alignment, but the remaining feet must be iambs to best satisfy rightward foot-head alignment. In (38b), the ranking PrWd-R >> Hds-Left produces a configuration where an iamb at the right edge is preceded by a string of trochees. The foot at the right edge must be an iamb in order to satisfy rightward prosodic word alignment, but the remaining feet must be trochees in order to best satisfy leftward foot-head alignment.

As far as I am aware, the types of configurations in (38) are both unattested, and if we are to make an extensive use of head-oriented alignment constraints, this particular result must be eliminated. The approach I will adopt is to posit a condition similar to the Lapse constraint of Selkirk 1984.⁴ Note, however, that the condition proposed below refers neither to gridmarks nor to stressed syllables but to the heads of feet.

(39) Lapse Condition

For every two adjacent syllables, one must be a foot-head.

Like Strict Succession, I take the Lapse Condition to be a non-violable restriction on the Gen. component of the grammar, so that forms which violate it cannot be considered as output candidates. The condition targets iambic-trochaic mixtures like those in (38) where a

⁴ For other related but more recent proposals, see Kager 1994, Green 1995, and Green and Kenstowicz 1995.

trochee is followed by an iamb, since it is in this type of configuration where two non-head syllables would be adjacent.

With the adoption of the Lapse Condition, ranking an Align (PrWd, Ft-Hd) constraint over an Align (Ft-Hd, PrWd) constraint of the opposite directionality produces the types of even-parity forms seen in (40), where the position of the head within the foot matches the directionality of the Align PrWd constraint rather than the Align Ft-Hd constraint.

(40) Restricting the Conflicting Directionality

a. PrWd- L >> Hds-Right

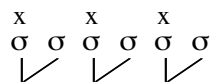

b. PrWd-R >> Hds-Left

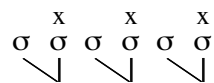

In (40a), the Lapse Condition and the ranking PrWd-L >> Hds-Right produces a string of trochees. Since there must be a foot-head at the left edge of the prosodic word to satisfy PrWd-L, the initial foot must be a trochee. The remaining feet would better satisfy Hds-Right if they were iambs, but since the Lapse Condition bans structures where iambs follow trochees, these feet must remain trochaic. In (40b), the Lapse Condition and the ranking PrWd-Right >> Hds-Left produces a string of iambs. The final foot must be iambic in order to satisfy PrWd-R. The remaining feet would better satisfy Hds-Left if they were trochaic, but since the Lapse Condition bans structures where iambs are preceded by trochees, these feet must remain iambic.

The most interesting effect of the Lapse Condition, however, is exhibited by odd-parity forms. The position of the head within the foot is still determined by the higher ranking Align (PrWd, Ft-Hd) constraint, but the footing directionality will be determined by the lower ranked Align (Ft-Hd, PrWd) constraint. This is illustrated for the ranking PrWd-R >> Hds-Left in the tableau in (41).

(41) PrWd-R >> Hds-Left

	$\sigma\sigma\sigma\sigma\sigma\sigma$	PrWd-R	Hds-Left
a.	$\begin{array}{cccccc} & x & & x & & x & & x \\ \sigma & \sigma & \sigma & \sigma & \sigma & \sigma & \sigma & \sigma \\ & \diagdown & & \diagdown & & \diagdown & & \diagdown \end{array}$		<p>** *** ***** (12)</p>
b.	$\begin{array}{cccccc} & x & & x & & x & & \sigma \\ \sigma & \sigma & \sigma & \sigma & \sigma & \sigma & \sigma & \sigma \\ & \diagdown & & \diagdown & & \diagdown & & \diagdown \end{array}$		<p>* *** ***** *****!*** (15)</p>
c.	$\begin{array}{cccccc} & x & & x & & x & & \sigma \\ \sigma & \sigma & \sigma & \sigma & \sigma & \sigma & \sigma & \sigma \\ \diagup & \diagup & & \diagup & & \diagup & & \diagup \end{array}$	*!	<p>* *** ***** (9)</p>

Candidate (a) has a foot-head at the right edge of the prosodic word, all others being aligned as far to the left as possible without violating the Lapse Condition. The foot-head at the right edge allows it to satisfy PrWd-R, but neither its rightward nor leftward foot-head alignment are optimal. Candidate (b) exhibits the best possible rightward foot-head alignment. Although the foot-head at the right edge allows (b) to satisfy PrWd-R, its leftward foot-head alignment is not optimal, being even worse than that of candidate (a). Since it does better on leftward foot-head alignment, candidate (a) prevails over (b). Candidate (c) exhibits the best possible leftward foot-head alignment, but it does not have a foot-head at its right edge, leading to a violation of PrWd-R. Since prosodic word alignment is the higher ranked constraint, candidate (a) prevails over (c) as well.

Although PrWd-R and the Lapse Condition demand right-headed feet in (41), Hds-Left demands that the heads of these feet occur as far to the left in the prosodic word as possible, giving a configuration of iambs with leftward footing directionality. Since the reasoning is much the same for the mirror image trochaic pattern, I will omit the additional tableau.

The addition of the Align (PrWd, Ft-Hd) constraints and the Lapse Condition to the grammar have introduced the possibility for symmetrical conflict between the position of the head within the foot and the direction of foot alignment and have allowed the theory to add

the maximal alternation patterns to the already obtained minimal alternation patterns. At this point, then, the proposed account is limited to exactly the four stress patterns of the symmetrically attested portion of the typology— the iambic and trochaic patterns of both minimal and maximal alternation. The grammar produces minimal alternation patterns when the directional specifications of foot-head alignment and prosodic word alignment match, or when foot-head alignment ranks above prosodic word alignment. The grammar produces maximal alternation patterns when prosodic word alignment ranks over foot-head alignment and the directional specifications of the two do not match. This is summarized in the table below:

(42) Predicted Typology

Minimal Alternation

a. Hds-Left, PrWd-L

or

Hds-Left >> PrWd-R

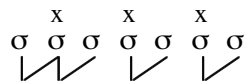
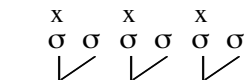

b. Hds-Right, PrWd-R

or

Hds-Right >> PrWd-L

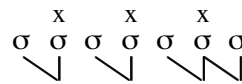
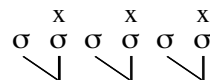

Maximal Alternation

c. PrWd-L >> Hds-Right

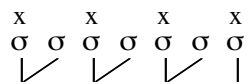
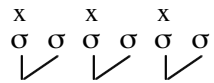

d. PrWd-R >> Hds-Left

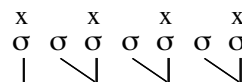
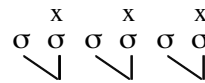

Having limited the theory to the patterns of the symmetrically attested portion of the typology, we now turn to the asymmetrically attested portion, consisting of the double offbeat, double downbeat, edge ternary, and internal ternary patterns.

1.3.3 NonFinality

As mentioned earlier, I consider the symmetrically attested patterns of the typology—minimal and maximal alternation—to be the core patterns produced by the theory, with others being variations on these core types. These patterns are core types in the sense that the theory’s alignment constraints, in conjunction with the theory’s primary assumptions, are oriented towards producing just these configurations. The remainder of the patterns are variations on the core patterns in the sense that they will have much the same footing as the core patterns but will be associated with the metrical grid in different ways.

Unlike the Alignment constraints, which are symmetrical in nature, the constraints that will be added to the theory to obtain the remaining patterns are asymmetrical in nature. The first of these constraints is NonFinality. Although I will advance a more general theory of NonFinality effects in Chapter 4, for now we will use the following individual formulation:

(43) NonFinality

Stress may not occur on the final syllable of a prosodic word.

This constraint, based loosely on the NonFinality constraint of Prince and Smolensky 1993, simply demands that the final syllable of a prosodic word be stressless.

1.3.3.1 The Double Offbeat Pattern

In the proposed account, double offbeat patterns can be considered to be gridmark variations on maximal alternation footing. Unlike the maximal alternation patterns, which have strictly alternating stress, double offbeat patterns have two adjacent unstressed syllables occurring at one edge or the other in odd-parity forms. The pattern is attested for trochaic systems by Pintupi (Hansen and Hansen 1969), for example:

(44) Pintupi

Even	tjámulìmpatjùŋku	<i>our relation</i>
Odd	tíliřìŋulàmpatju	<i>the fire for our benefit flared up</i>

The mirror image in iambic systems is unattested.

To illustrate how NonFinality helps to obtain the correct asymmetrical prediction for double offbeat patterns, it is helpful to contrast the odd-parity forms of this type to those of maximal alternation:

(45) Maximal Alternation vs. Double Offbeat

Maximal Alternation

a. Trochaic

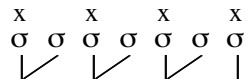

b. Iambic

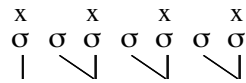

Double Offbeat

c. Trochaic

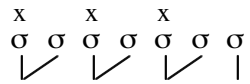

d. Iambic



The difference between the trochaic maximal alternation pattern (45a) and the trochaic double offbeat pattern (45c) is the presence of stress on the final syllable of the odd-parity form in (45a) and the absence of stress in the same position in (45c). The difference between the iambic maximal alternation pattern (45b) and the iambic double offbeat pattern (45d) is the presence of stress on the initial syllable of the odd-parity form in (45b) and the absence of stress in the same position in (45d).

The asymmetry in attestation can be traced in the proposed account to the asymmetry of NonFinality. Because NonFinality can ban stress from the final syllable of a prosodic word but cannot ban stress from the initial syllable, the constraint has the ability to distinguish between trochaic maximal alternation and double offbeat patterns, as (46) illustrates, but not between iambic maximal alternation and double offbeat patterns, as (47) illustrates:

(46) Violations of NonFinality: Trochaic Systems

σσσσσσσ	NonFinality
a. $\begin{array}{cccc} & x & & x & & x & & x \\ \sigma & \sigma & \sigma & \sigma & \sigma & \sigma & \sigma & \sigma \end{array}$	*
b. $\begin{array}{cccc} & x & & x & & x & & \\ \sigma & \sigma & \sigma & \sigma & \sigma & \sigma & \sigma & \sigma \end{array}$	

(47) Violations of NonFinality: Iambic Systems

σσσσσσσ	NonFinality
a. $\begin{array}{cccc} & x & & x & & x & & x \\ \sigma & \sigma & \sigma & \sigma & \sigma & \sigma & \sigma & \sigma \end{array}$	*
b. $\begin{array}{cccc} & & & x & & x & & x \\ \sigma & \sigma & \sigma & \sigma & \sigma & \sigma & \sigma & \sigma \end{array}$	*

In (46), the trochaic maximal alternation pattern (a) violates NonFinality, but the trochaic double offbeat pattern (b) does not. As NonFinality prefers the configuration in (b) over the configuration in (a), it can be used to distinguish between them. In (47), both iambic patterns, maximal alternation in (a) and double offbeat in (b), violate NonFinality. As the constraint has no preference for one over the other, it cannot be used to distinguish between them.

The proposed account can obtain the trochaic double offbeat pattern by using the alignment ranking of trochaic maximal alternation— PrWd-L >> Hds-Right— to establish the pattern of foot parsing and the position of the heads within the feet and by using the ranking NonFinality >> MapGridmark to force the final degenerate foot of odd-parity forms to be stressless. This last part of the ranking is illustrated in the tableau in (48).

(48) NonFinality >> MapGridmark

	σσσσσσ	NonFinality	MapGM
a.	$\begin{array}{cccccc} & x & & x & & x \\ \sigma & \sigma & \sigma & \sigma & \sigma & \sigma & \sigma \\ & \swarrow & & \swarrow & & \swarrow & \end{array}$		*
b.	$\begin{array}{cccccc} & x & & x & & x & & x \\ \sigma & \sigma & \sigma & \sigma & \sigma & \sigma & \sigma & \sigma \\ & \swarrow & & \swarrow & & \swarrow & & \end{array}$	*!	

In (48), the foot patterns of the (a) and (b) candidates are identical, being those obtained by the alignment ranking PrWd-L >> Hds-Right. Each candidate has a final degenerate foot preceded by a string of left-headed disyllabic feet. Each foot of the (b) candidate has a gridmark within its domain, but since this circumstance means that the final syllable is stressed, (b) incurs a violation of NonFinality. In the (a) candidate, each of the disyllabic feet is associated with a gridmark, but the final degenerate foot is not, leading to a violation of MapGridmark. Since NonFinality is the higher ranked constraint, (a) is the winner.

Both the trochaic maximal alternation pattern and the double offbeat pattern have the same footing, but they differ in how the grammar associates this footing with the metrical grid. When MapGridmark ranks above NonFinality, the final degenerate foot of odd-parity forms will be stressed, resulting in the maximal alternation pattern. When NonFinality ranks above MapGridmark, the final degenerate foot of odd-parity forms will not be stressed, resulting in the double offbeat pattern. Since the crucial difference between the iambic maximal alternation and double offbeat patterns is the presence or absence of initial stress, NonFinality cannot be used to distinguish between them. This would require the presence of a reverse constraint, like “NonInitial”, a constraint that is crucially absent from the theory.

1.3.3.2 The Internal Ternary Pattern

The distinguishing characteristic of internal ternary patterns is that trochaic systems have a dactyl preceding penultimate stress in odd-parity forms and iambic systems have an anapest following peninitial stress in odd-parity forms. The internal ternary configuration is exhibited in trochaic systems by Piro (Matteson 1965), for example:

(49) Piro

Even	pèṭṣìṭṣhìmatlóna	<i>they say they stalk it</i>
Odd	rùslunòtinitkána	<i>their voices already changed</i>

The mirror image in iambic systems is unattested.

Like double offbeat patterns, I consider the internal ternary patterns to also be variations on maximal alternation. With internal ternary patterns, however, the difference in gridmark mapping is not the result of a stressless foot but of a slight adjustment in the type of footing. This is illustrated more clearly in comparing the proposed footing of odd-parity forms for maximal alternation and internal ternary patterns in (50) below.

(50) Maximal Alternation vs. Internal Ternary

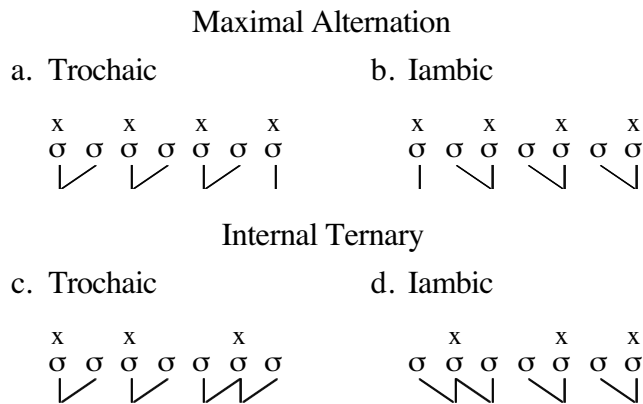

The difference between maximal alternation and internal ternary footing in trochaic systems is that the head of the final degenerate foot in the maximal alternation form (a) moves back by one syllable in the internal ternary form (c) so that the final foot is a trochee. With stress occurring in the intersection of the final two feet, rather than on the penult and the ultima, the gridmark configuration of the trochaic internal ternary pattern emerges. The difference in

iambic systems is that the head of the initial degenerate foot of the maximal alternation form (b) moves forward by one syllable in the internal ternary form (d) so that the initial foot is an iamb. With stress occurring in the intersection of the initial two feet, rather than on the initial and post-peninitial syllables, the gridmark configuration of the iambic internal ternary pattern emerges.

The key to obtaining the asymmetrical attestation of internal ternary patterns is a constraint that will allow the grammar to prefer trochees over degenerate feet (or even iambs) at the right edge of a form but that will not allow the grammar to prefer iambs over degenerate feet (or even trochees) at the left edge of a form. In other words, we want a constraint that distinguishes between internal ternary and maximal alternation patterns for trochaic systems but not for iambic systems. As (51) and (52) demonstrate, NonFinality is just such a constraint:

(51) Violations of NonFinality: Trochaic Systems

σσσσσσσ	NonFinality
a. $\begin{array}{cccc} & x & & x & & x & & x \\ \sigma & \sigma & \sigma & \sigma & \sigma & \sigma & \sigma & \sigma \end{array}$	*
b. $\begin{array}{cccc} & x & & x & & & & x \\ \sigma & \sigma & \sigma & \sigma & \sigma & \sigma & \sigma & \sigma \end{array}$	

(52) Violations of NonFinality: Iambic Systems

σσσσσσσ	NonFinality
a. $\begin{array}{cccc} & x & & x & & x & & x \\ \sigma & \sigma & \sigma & \sigma & \sigma & \sigma & \sigma & \sigma \end{array}$	*
b. $\begin{array}{cccc} & & & x & & x & & x \\ \sigma & \sigma & \sigma & \sigma & \sigma & \sigma & \sigma & \sigma \end{array}$	*

In (51), the trochaic maximal alternation pattern (a) violates NonFinality, but the trochaic internal ternary pattern (b) does not. As NonFinality prefers the configuration in (b) over the configuration in (a), it can thus be used to distinguish between them. In (52), both iam-

bic patterns, maximal alternation in (a) and internal ternary in (b), violate NonFinality. As the constraint has no preference for one over the other, it cannot be used to distinguish between them.

To obtain the trochaic internal ternary pattern, we can use the same alignment ranking— PrWd-L >> Hds-Right— as for the maximal alternation pattern, but to force the final foot of odd-parity forms to be a trochee instead of a monosyllable, NonFinality must rank above Hds-Right:

(53) NonFinality >> Hds-Right

	σσσσσσ	NonFinality	Hds-Right
a.	$\begin{array}{ccccccc} & x & & x & & & x \\ \sigma & \sigma & \sigma & \sigma & \sigma & \sigma & \sigma \\ & \swarrow & & \swarrow & & \swarrow & \swarrow \end{array}$		<p>* * * * *</p> <p>(13)</p>
b.	$\begin{array}{ccccccc} & x & & x & & x & x \\ \sigma & \sigma & \sigma & \sigma & \sigma & \sigma & \sigma \\ & \swarrow & & \swarrow & & \swarrow & \end{array}$	* !	<p>** * * * *</p> <p>(12)</p>

In (53), the (a) candidate is parsed using a string of trochees with the final two in an intersecting configuration. The (b) candidate is parsed using a string of trochees followed by a monosyllabic foot. The position of the head in its final foot causes (a) to have one more alignment violation than (b), but it also allows (a) to satisfy NonFinality where (b) does not. Since NonFinality is the higher ranked constraint, (a) is the winner.

The grammar produces the trochaic internal ternary pattern, then, as a variation on maximal alternation through the minimal compromise of rightward foot-head alignment to accommodate NonFinality. There can be no mirror image iambic pattern as there is no “NonInitial” constraint to compromise leftward foot-head alignment. The theory is thus able to predict the asymmetrically attested edge ternary patterns because it has one more way to obtain a trochaic foot than it does to obtain an iambic foot.

1.3.4 Initial Gridmark

The second type of asymmetrical constraint that will be introduced to the theory is the Initial Gridmark constraint. This constraint, too, will receive a more generalized treatment in Chapter 4, but for now we can use the following individual formulation:

(54) Initial Gridmark

A foot-level gridmark occurs over the initial syllable.

Initial Gridmark is the opposite of NonFinality in two ways. First, it applies to the initial element of a domain rather than the final, and second, it demands stress rather than stresslessness. The significance of Initial Gridmark to the theory is that its satisfaction can reintroduce the potential for conflict— to this point negated by the possibility of intersection— between *Clash and MapGridmark. Since the effects of Initial Gridmark are limited to the left edge of a form, however, the potential conflict is reintroduced only at the left edge and not at the right edge.

1.3.4.1 The Double Downbeat Pattern

The distinguishing characteristic of the double downbeat pattern is that it has two adjacent stressed syllables at one edge or the other in odd-parity forms. This pattern is attested in trochaic systems by Passamaquoddy (LeSourd 1993), for example:

(55) Passamaquoddy

Even	wícohkémal	<i>he helps the other</i>
Odd	wícóhkekémo	<i>he helps out</i>

In iambic systems the pattern is unattested.

In the proposed account, the double downbeat pattern can be considered to be a variation on how gridmarks are associated with minimal alternation footing. This can be seen in comparing the proposed structure of double downbeat odd-parity forms with that of minimal alternation odd-parity forms:

(56) Minimal Alternation vs. Double Downbeat

Minimal Alternation

a. Trochaic

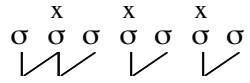

b. Iambic

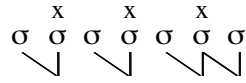

Double Downbeat

c. Trochaic

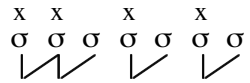

d. Iambic

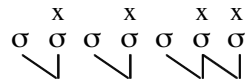

Double downbeat and minimal alternation patterns both exhibit simple leftward foot-head alignment with an intersection⁵ at the left edge in the trochaic versions and simple rightward foot-head alignment with an intersection at the right edge in the iambic versions. The two types, however, differ slightly on how this footing is related to the metrical grid. The trochaic double downbeat configuration (56c) has the same stress pattern as the minimal alternation configuration (56a), except that the initial syllable of (56c) is stressed where the initial syllable of (56a) is unstressed. The iambic double downbeat configuration (56d) has the same stress pattern as the minimal alternation configuration (56b) except that the final syllable of (56d) is stressed where the final syllable of (56b) is unstressed.

The asymmetry in attestation between trochaic and iambic double downbeat patterns can be traced to the asymmetry of the Initial Gridmark constraint. Because Initial Gridmark demands that initial syllables be stressed but does not demand that final syllables be stressed, Initial Gridmark can distinguish between the trochaic versions of minimal alternation and double downbeat patterns but not between the iambic versions. In other words, Ini-

⁵ Since the intersecting configurations were originally introduced as a means to avoid clash while still satisfying MapGridmark, one might wonder why the intersecting configuration is retained in the double downbeat pattern, where *Clash is violated, and in the edge ternary pattern, where MapGridmark is violated. The alternative to an intersection, a degenerate foot followed by a trochee, would seem to serve equally well in both cases. The intersection in these patterns is in anticipation of a constraint that I will introduce in Chapter 4, a constraint requiring NonFinality within the foot. Intersection allows the initial gridmark to be non-final in its foot where a degenerate foot would not.

tial Gridmark gives us a reason to have a clash configuration at the left edge in trochaic systems but not at the right edge in iambic systems:

(57) Violations of Initial Gridmark: Trochaic Systems

σσσσσσσ	Initial Gridmark
<p>a. x x x σ σ σ σ σ σ σ</p> <p>b. x x x x σ σ σ σ σ σ σ</p>	*

(58) Violations of Initial Gridmark: Iambic Systems

σσσσσσσ	Initial Gridmark
<p>a. x x x σ σ σ σ σ σ σ</p> <p>b. x x x x σ σ σ σ σ σ σ</p>	*

As (57) demonstrates, the trochaic minimal alternation pattern (a) violates Initial Gridmark, but the trochaic double downbeat pattern (b) does not. As Initial Gridmark prefers the configuration in (b) over the configuration in (a), it can thus be used to distinguish between them. As (58) demonstrates, both iambic patterns, minimal alternation in (a) and double downbeat in (b), violate Initial Gridmark. Since the constraint has no preference for one over the other, it cannot be used to distinguish between them.

In obtaining the trochaic double downbeat pattern, foot-heads are aligned to the left as in minimal alternation to establish the appropriate footing. Given leftward alignment, the crucial interaction is between the requirements of Initial Gridmark and MapGridmark on one hand and *Clash on the other. Although the even-parity double downbeat configuration satisfies the demands of Initial Gridmark and MapGridmark simultaneously without clash, the stress pattern of the odd-parity configuration results from the situation where the demands of both Initial Gridmark and MapGridmark are met at *Clash's expense. With left-

ward foot-head alignment, MapGridmark’s demand that all feet have a gridmark within their domain means that the head of the second foot— the second syllable— must have a gridmark. Initial Gridmark demands that stress occur on the first syllable, as well. Since these gridmarks will be adjacent with no intervening entry on the base level, *Clash will be violated. The tableau below demonstrates more clearly:

(59) Initial Gridmark, MapGridmark >> *Clash

	σσσσσσ	IntGM	MapGM	*Clash
a.				*
b.			*!	
c.		*!		

Each of the three candidates in (59) has optimal leftward foot-head alignment with two adjacent heads at the left edge of the form. The (a) candidate illustrates the double downbeat configuration, where foot-level gridmarks occur on both the first and second syllables. This candidate satisfies both Initial Gridmark and MapGridmark but does so at the expense of violating *Clash. Candidate (b) only has stress on its initial syllable, satisfying Initial Gridmark and *Clash but violating MapGridmark. Candidate (c) satisfies MapGridmark without violating *Clash, as the gridmark over the second syllable counts for both of the first two feet. This configuration, however, comes at the expense of Initial Gridmark, as there is no gridmark over the first syllable. Since (a) does better than (b, c) with respect to the two higher ranked constraints, it is the winner. Also, since there is no constraint like “Final Gridmark”, the grammar cannot obtain the (a) candidate’s iambic mirror image.

1.3.4.2 The Edge Ternary Pattern

The final patterns from the typology of (10, 11), are the edge ternary patterns. The distinguishing characteristic of this type is that it has an dactyl at the left edge in trochaic odd-parity forms and an anapest at the right edge in iambic odd-parity forms. The edge ternary pattern is attested in trochaic systems by Garawa (Furby 1974), for example:

(60) Garawa

Even	yákalàkalàmpa	<i>loose</i>
Odd	ḡánkiřikìřimpàyi	<i>fought with boomerangs</i>

The mirror image in iambic systems is unattested.

Like the double downbeat pattern just discussed, the edge ternary pattern can also be considered a variation on minimal alternation footing. As illustrated for odd-parity forms below, the proposed structures for edge ternary patterns have the same footing as those proposed for minimal alternation structures, but the two types differ in how they relate to the metrical grid:

(61) Minimal Alternation vs. Edge Ternary

Minimal Alternation

a. Trochaic

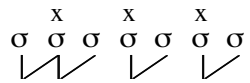

b. Iambic

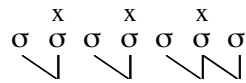

Edge Ternary

c. Trochaic

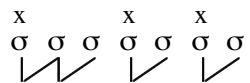

d. Iambic



Edge ternary and minimal alternation patterns both exhibit simple leftward foot-head alignment with an intersection (see footnote 5) at the left edge in the trochaic versions and simple rightward foot-head alignment with an intersection at the right edge in the iambic versions. The difference between the trochaic minimal alternation pattern (61a) and the trochaic edge ternary pattern (61c) is that the gridmark on the penultimate syllable of the minimal alternation

pattern shifts to the initial syllable in the edge ternary pattern. The difference between the iambic minimal alternation pattern (61b) and the iambic edge ternary pattern (61d) is that the gridmark on the penult in minimal alternation pattern shifts to the ultima in the edge ternary pattern.

As with the double downbeat patterns, the asymmetry in attestation of the edge ternary patterns can be traced to the Initial Gridmark constraint. Initial Gridmark can provide a reason for stress to occur on the initial rather than the peninitial syllable of a form but cannot provide a reason for stress to occur on the final rather than the penultimate syllable of a form. In other words, Initial Gridmark can distinguish between trochaic minimal alternation and edge ternary patterns, as (62) demonstrates, but not between iambic minimal alternation and edge ternary patterns, as (63) demonstrates.

(62) Violations of Initial Gridmark: Trochaic Systems

σσσσσσσ	Initial Gridmark
a. x x x σ σ σ σ σ σ σ	*
b. x x x σ σ σ σ σ σ σ	

(63) Violations of Initial Gridmark: Iambic Systems

σσσσσσσ	Initial Gridmark
a. x x x σ σ σ σ σ σ σ	*
b. x x x σ σ σ σ σ σ σ	*

In (62), the trochaic minimal alternation pattern (a) violates Initial Gridmark, but the trochaic edge ternary pattern (b) does not. As Initial Gridmark prefers the configuration in (b) over the configuration in (a), it can be used to distinguish between them. In (63), both iambic

patterns, minimal alternation in (a) and edge ternary in (b), violate Initial Gridmark. As the constraint has no preference, it cannot be used to distinguish between them.

The grammar can obtain the trochaic edge ternary pattern because the demands of Initial Gridmark and MapGridmark produce the potential for clash in odd-parity forms with leftward foot-head alignment. If clash is to be avoided, the demands of either Initial Gridmark or MapGridmark must yield, and in the case of the edge ternary pattern, it is Initial Gridmark that prevails. As in the minimal alternation pattern, Hds-Left establishes the appropriate footing, and the ranking Initial Gridmark, *Clash >> MapGridmark establishes the appropriate mapping of gridmarks. Notice that the positions of *Clash and MapGridmark have simply been reversed from the positions they occupied in the double downbeat ranking above:

(64) Initial Gridmark, *Clash >> MapGridmark

	σσσσσσ	IntGM	*Clash	MapGM
a.	$\begin{array}{cccc} x & x & & x & x \\ \sigma & \sigma & \sigma & \sigma & \sigma & \sigma & \sigma \\ \swarrow & \swarrow & \swarrow & \swarrow & \swarrow & \swarrow & \swarrow \end{array}$		*!	
b.	$\begin{array}{cccc} x & & x & & x \\ \sigma & \sigma & \sigma & \sigma & \sigma & \sigma & \sigma \\ \swarrow & \swarrow & \swarrow & \swarrow & \swarrow & \swarrow & \swarrow \end{array}$			*
c.	$\begin{array}{cccc} & x & & x & & x \\ \sigma & \sigma & \sigma & \sigma & \sigma & \sigma & \sigma \\ \swarrow & \swarrow & \swarrow & \swarrow & \swarrow & \swarrow & \swarrow \end{array}$	*!		

In (64), the candidates and their respective violations are the same as in the double downbeat tableau of (59). As before, the (c) candidate, with its initial syllable unstressed, drops out at Initial Gridmark. With the higher ranking of *Clash, candidate (a) is the next to drop out due to its adjacent stressed syllables. This leaves candidate (b), which satisfies *Clash and Initial Gridmark at the expense of MapGridmark, as the winner. Again, since there is no constraint “Final Gridmark” to create a conflict between MapGridmark and *Clash at the right edge of a form, the grammar cannot obtain the mirror image iambic pattern.

1.4 Summary

With respect to the typology in (10, 11), the proposed account correctly predicts the attested patterns and also correctly fails to predict the unattested patterns. Those patterns that are symmetrically attested are symmetrically predicted, and those patterns that are asymmetrically attested are asymmetrically predicted. In obtaining these results, it was necessary to make several departures from the standard account— departures in terms of both constraints and structural assumptions.

One of the proposed structural assumptions was formulated as a condition on the Gen. component of the grammar, having been a violable constraint in the standard approach:

(65) Condition *vs.* Constraint

Proposed Condition

Standard Constraint

Strict Succession

Parse-Syll

The Parse-Syll constraint of the standard account was incorporated into a general Strict Succession Condition, aimed at eliminating the possibility of non-parsing as a treatment for syllables in general and for odd syllables in particular.

A second assumption was freely allowing in the grammar a configuration that was previously banned— improper bracketing:

(66) Bracketing

Proposed Assumption

Standard Assumption

Improper Bracketing Tolerated

Proper Bracketing Demanded

Allowing improper bracketing introduced to the account a possible treatment for odd syllables besides parsing them as monosyllabic feet. It also allowed the theory to take advantage of the new formulation for the foot-gridmark relationship.

Modifications to the constraint inventory took different forms. Some constraints, such as NonFinality and *Clash, were taken from earlier accounts, and one, Initial Gridmark, is completely new. The MapGridmark constraint modified the previously assumed one-to-one correspondence between feet and stress by making it violable and by making it

possible for feet to share a stress. Foot-head alignment constraints took the place of foot alignment constraints:

(67) Constraints

<u>Proposed</u>	<u>Standard</u>
MapGridmark Constraint	One-to-One Correspondence between Stress and Feet (non-violable)
Foot-Head Alignment	Foot Alignment

In the outline of the account presented above, the strategy was to establish a high degree of restrictiveness at the outset, eliminating entirely the asymmetrically attested patterns, and then to loosen these restrictions in ways that would reintroduce these patterns with the desired asymmetry. One key aspect of this approach was eliminating the possibility of conflict between the head's position within the foot and foot alignment directionality through Strict Succession and foot-head alignment, and then reintroducing the possibility of conflict in a limited way with prosodic word alignment. A second key aspect was the elimination of clashing patterns at either edge of a form through the toleration of improper bracketing and the reformulation of the foot-gridmark relationship, and then the reintroduction of these patterns at the left edge only with the Initial Gridmark constraint. The result was a theory that predicted iambic and trochaic patterns for the minimal and maximal alternation types but predicted only trochaic patterns for the double offbeat, double downbeat, edge ternary, and internal ternary types.

CHAPTER TWO
THREE SYSTEMS

The conception of metrical stress theory in the proposed account is a modular one. The account posits several distinguishable systems that interact with each other through the mechanisms of Optimality Theory. Although I take some restrictions to be universal and non-violable; in general, violable constraints provide the means of interaction, and the ranking of these constraints determines the nature of the interaction. In this chapter, we will examine three of these systems— the Prosodic Hierarchy, Prosodic Prominence, and the Metrical Grid— and some of the basic conditions and constraints that facilitate or restrict interaction between them.

2.1 The Prosodic Hierarchy

The Prosodic Hierarchy originated in the work of Selkirk (1980a, b) and, with some subsequent modification, has become a central component of phonological theory. The makeup of the hierarchy that I will adopt in this account is essentially the same as that advocated in McCarthy and Prince 1993b. I take the lower levels of the hierarchy to be as follows:

(1) Lower Prosodic Categories

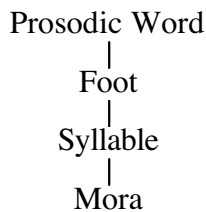

The illustration in (1) gives us two important pieces of information. It tells us what the lower level prosodic categories are, the categories that will concern us in this account, and it tells us the dominance relations that hold between them. I take the dominance relation to be one of immediate dominance. Moras are immediately dominated by syllables, syllables are immediately dominated by feet, and feet are immediately dominated by prosodic words.

2.1.1 The Traditional Configuration

The traditional configuration of the prosodic hierarchy is one where a mora belongs to one and only one syllable, a syllable belongs to one and only one foot, a foot belongs to one and only one prosodic word, etc., and where every instance of a prosodic category is dominated by an instance of the next higher category:

(2) Traditional Configuration of the Prosodic Hierarchy

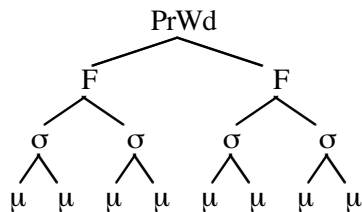

This configuration is one conforming to the formulations of both Proper Bracketing and Strict Succession laid out in Ito and Mester 1992:¹

(3) Strict Succession (Ito and Mester 1992)

Every C_j ($\neq C_{\max}$) is immediately dominated by C_{j+1} (i.e. category levels are never skipped.)

(4) Proper Bracketing (Ito and Mester 1992)

Every C_j ($\neq C_{\max}$) has one and only one mother node (i.e. a given prosodic constituent cannot simultaneously be part of two or more higher prosodic constituents.)

Strict Succession ensures that all instances of some category level will be included in instances of the next higher category level. In other words, it insures exhaustive parsing, or the immediate dominance relation mentioned above. Proper Bracketing ensures that two instances of some category level may not share an instance of a lower category level. In other words, it prevents prosodic categories from intersecting. As discussed in Chapter 1, I take Strict Succession to be a universal and non-violable condition on the Gen. component of the grammar, but Proper Bracketing is completely absent. Although the traditional configuration of the hierarchy will still occur, the grammar will tolerate intersecting configurations as well.

¹ See also Nespor and Voegel 1986 and Selkirk 1984.

2.1.2 The Intersecting Configuration

The intersecting, or improperly bracketed, configuration is one where a mora belongs to two syllables, a syllable belongs to two feet, a foot belongs to two prosodic words, etc., as illustrated below:

(5) Intersecting Configurations

a. Syllables

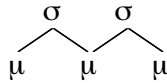

b. Feet

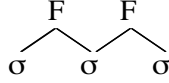

c. Prosodic Words

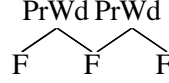

The (5) structures conform to Strict Succession—every mora is immediately dominated by a syllable, every syllable immediately dominated by a foot, and every foot immediately dominated by a prosodic word— but these structures do not conform to Proper Bracketing. In (a), the second mora belongs to two syllables; in (b), the second syllable belongs to two feet; and in (c), the second foot belongs to two prosodic words.

It is appropriate to mention in connection with intersections two further conditions affecting prosodic structure: Contiguity and Uniqueness of Domain. Both of these conditions take the form of restrictions on Gen., so that they are universal and non-violable:

(6) Contiguity

The constituents of prosodic categories are contiguous.

(7) Uniqueness of Domain

All prosodic categories of the same level are unique with respect to their domains.

The first condition, Contiguity, ensures that all the constituents of a prosodic category will be adjacent. This is a well-known and accepted assumption, but I mention it because it is important for showing what the intersecting configuration is not. Contiguity bans, for example, feet that straddle a syllable without including it:

(8) Non-Contiguity

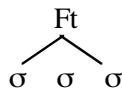

In the (8) configuration, the foot consists of the first and third syllables but does not include the second. The foot's constituents are not contiguous.

The structures in (9) have a foot with the same configuration as (8), but this time the skipped syllable is included in a second foot.

(9) Crossing Association Lines

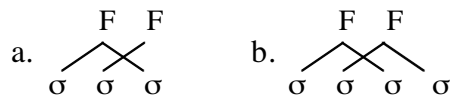

In (9a), the first foot consists of the first and third syllables, and the second foot consists of the second syllable. In (9b), the first foot consists of the first and third syllables, and the second foot consists of the second and fourth syllables. As their syllabic constituents are not adjacent, these feet are banned by Contiguity.

The significance of these examples is that intersection is crucially the sharing of constituents by two prosodic categories and not merely the crossing of association lines. Crossing association lines without sharing constituents, as in (9), violates Contiguity and is not tolerated in the theory.

The second condition, Uniqueness of Domain, means that categories of the same level may overlap but may not take up exactly the same space. For example, the following configuration of feet, where one foot consists of exactly the same set of syllables as another, is prohibited:

(10) Intersection Resulting in Equivalent Domains



The two feet in (10) fail to conform to Uniqueness of Domain because the first foot consists of the first and second syllable, and the second foot also consists of the first and second syllable. The domain of neither foot is unique. In a sense, the two feet in this configuration are equivalent to a single foot with two heads. The significance of the uniqueness requirement for prosodic domains is that, when two adjacent syllables must be the heads of

feet, they cannot have the configuration in (10) but must have one of the types of configurations below:

(11) Configurations with Adjacent Heads



In (11a), the two heads are contained in two separate monosyllabic feet. In (11b), one head is contained in a monosyllabic foot, and the second is contained in a larger disyllabic foot that intersects the first. In (11c), both heads are contained in two different intersecting disyllabic feet.

2.1.3 Overcoming Pathologies

I have already briefly discussed in Chapter 1, and will examine in more detail below, the advantages that intersection brings to the grammar in terms of restricting basic stress patterns. There is, however, an additional advantage to tolerating improper bracketing. The advantage results from intersection’s ability to overcome a potential pathology in systems that can require both exhaustive parsing and exactly binary footing, a possibility that is common to both the standard and proposed approaches.

What I will call the “even only” pathology arises when forms must be exhaustively parsed into exactly binary feet on the surface. Since, under standard assumptions, only even-parity forms can satisfy this requirement, languages on which it is imposed can only have even-parity forms. In the standard account, the pathology would arise specifically under rankings where both Parse-Syll and Ft-Bin rank above one of the following two Faithfulness constraints:

(12) Faithfulness Constraints (adapted from McCarthy and Prince 1995)

Max: All material in the input must be present in the output.

Dep: All material in the output must be present in the input

The significance of the Faithfulness constraints is that they can prohibit deletion or insertion of material in an effort to satisfy Ft-Bin and Parse-Syll. If ranked highly enough, Max would prevent deletion of material that would mean fewer syllables in the output than if no deletion had occurred, and Dep would prevent insertion of material that would mean more syllables in the output than if no insertion had occurred.

Since, under the standard account, odd-parity forms cannot be exhaustively parsed into exactly binary feet, they cannot occur in a system where both Ft-Bin and Parse-Syll rank over either one of the two faithfulness constraints. When Ft-Bin and Parse-Syll rank over Max, for example, a single syllable will be deleted from odd-parity input strings:

(13) Odd/Even Alternations: Parse-Syll, Ft-Bin >> Max

- | | | | |
|----|----------------------------|---|-------------------------------|
| | Input | | Output |
| a. | Six Syllables
σσσσσσ | → | Six Syllables
(σσ)(σσ)(σσ) |
| b. | Seven Syllables
σσσσσσσ | → | Six Syllables
(σσ)(σσ)(σσ) |

The optimal output of a six-syllable form, as (13a) illustrates, is still a six-syllable form, but the optimal output of a seven-syllable form, as (13b) illustrates, is also a six-syllable form. Both satisfy Parse-Syll and Ft-Bin, but the form with the odd-parity input must satisfy them at the expense of Max.

In general with this ranking, the output of odd-parity input strings will be fewer by one syllable, as any candidate that would retain the odd syllable violates either Parse-Syll or Ft-Bin:

(14) Deletion with Odd-Parity Inputs

	σσσσσσσ	Parse-Syll	Ft-Bin	Max
☞ a.	(σσ)(σσ)(σσ)			*
b.	(σσ)(σσ)(σσ)(σ)		*!	
c.	(σσ)(σσ)(σσ)σ	*!		

In (14), the (c) candidate retains all of its syllables, and its odd-parity, but it does so at the cost of an unfooted syllable and drops out at Parse-Syll. The (b) candidate also retains all of its syllables, and its odd-parity, but at the cost of a monosyllabic foot. It drops out at Ft-Bin. Candidate (a) has a syllable deleted, making it even-parity, in violation of Max. Given the ranking, (a) is the winner.

A similar situation occurs under the standard account when both Parse-Syll and Ft-Bin dominate Dep. Only in this case, the demands of Parse-Syll and Ft-Bin will force a syllable to be added to odd-parity inputs:

(15) Odd/Even Alternations with Parse-Syll, Ft-Bin >> Dep

- | | | | |
|----|----------------------------|---|-------------------------------------|
| | Input | → | Output |
| a. | Six Syllables
σσσσσσ | | Six Syllables
(σσ)(σσ)(σσ) |
| b. | Seven Syllables
σσσσσσσ | | Eight Syllables
(σσ)(σσ)(σσ)(σσ) |

Again, the optimal output of a six-syllable form, as (15a) illustrates, is a six-syllable form, but this time the optimal output of a seven-syllable form, as (15b) illustrates, is an eight-syllable form. The odd-parity input adds a syllable, satisfying Parse-Syll and Ft-Bin at the expense of Dep.

In general with this ranking, the output of odd-parity input strings will be larger by one syllable, as any candidate that would avoid the additional syllable violates either Parse-Syll or Ft-Bin:

(16) Insertion with Odd-Parity Inputs

	σσσσσσσ	Parse-Syll	Ft-Bin	Dep
☞ a.	(σσ)(σσ)(σσ)(σσ)			*
b.	(σσ)(σσ)(σσ)(σ)		*!	
c.	(σσ)(σσ)(σσ)σ	*!		

In the tableau in (16), the (b) and (c) candidates retain the odd-parity of the input form. For (c), this comes at the cost of an unfooted syllable and a violation of Parse-Syll. For (b), it comes at the cost of a monosyllabic foot and a violation of Ft-Bin. Although candidate (a) has an additional syllable in violation of Dep, the additional syllable makes (a) even-parity and allows it to emerge as the winner.

Under the standard account, then, there is no way to avoid the “even only” pathology, since it is not possible for odd-parity forms to satisfy both Ft-Bin and Parse-Syll simultaneously. Because the option of improper bracketing, however, is always available in the proposed account, the proposed account does not suffer from the same difficulty. If the grammar allows feet to intersect, as (17) demonstrates, odd-parity forms can have exhaustive parsing (as they must in the proposed account due to Strict Succession) and exactly binary footing without violating either Max or Dep.

(17) Odd-Parity with Intersection

	σσσσσσσ	Dep	Max
a.			
b.			*!
c.		*!	

In (17), each candidate satisfies both Ft-Bin and Parse-Syll. Because (c) satisfies the two constraints by adding a syllable to create an even parity string, it violates Dep, and because (b) satisfies the two constraints by deleting a syllable to create an even-parity string, it violates Max. Because candidate (a), however, allows two disyllabic feet to intersect, it does not need to have even-parity to satisfy Parse-Syll and Ft-Bin, and so has no need to violate either Max or Dep.

The option, then, of allowing feet to intersect not only restricts the basic stress patterns that the grammar allows, but it also eliminates the “even only” pathology. Next, I will

discuss the proposed approach to foot-binarity and briefly examine its departures from the standard account.

2.1.4 Foot Binarity

There are substantial differences between the proposed approach to foot-binarity and the approach to foot-binarity in the standard account. In the proposed account, the primary mechanism enforcing binary footing is the FootCap Condition:

(18) FootCap Condition

Feet are maximally disyllabic.

As stated in (18), the FootCap Condition is a restriction on a foot's maximum size. It prohibits feet from containing more than two syllables.

The primary mechanism for enforcing binary footing in the standard approach is the Ft-Bin constraint, introduced in Prince and Smolensky 1993 and McCarthy and Prince 1993a, b.²

(19) Ft-Bin (from McCarthy and Prince 1993a)

Feet must be binary under syllabic or moraic analysis.

As stated in (19), the formulation is complex, being capable of satisfaction at either the syllabic or moraic level. Departure from binarity in one of the two levels is permitted. For example, feet can be larger than bimoraic if they are still disyllabic, and they can be smaller than disyllabic if they are still bimoraic. Only the departure from binarity on both levels is prohibited.

The option of satisfying the constraint at either of the two levels means that departures from binarity in the direction of larger-than-binary are only truly significant at the syllabic level and that departures from binarity in the direction of smaller-than-binary are

² The definition of Ft-Bin given in (19) has significant precedent in the literature, including McCarthy and Prince 1986 and, more distantly, Prince 1980.

only truly significant at the moraic level.³ Given this situation, the following formulation is equivalent to that of (19):

(20) Ft-Bin (Equivalent Formulation)

Feet are maximally disyllabic and minimally bimoraic.

Stated in the terms of (20), we can see more directly the restrictions that Ft-Bin imposes. Any foot that fails either or both of the conjuncts will be in violation.

There are two fundamental differences between FootCap and Ft-Bin. The first is that FootCap is a non-violable condition on the Gen. component of the grammar, where Ft-Bin is typically taken to be a violable constraint.⁴ Under the Ft-Bin constraint, it is possible for the grammar to obtain non-binary feet, either of the larger ternary and unbounded types or the smaller monomoraic type.⁵ Under the FootCap Condition, however, forms containing feet which are larger than disyllabic cannot be considered as output candidates. Unbounded and ternary feet are not merely restricted by the grammar, they are banned by the grammar. The reason for this stronger position is primarily that neither ternary nor unbounded feet are needed under the proposed approach (see Prince 1985 for arguments against the existence of larger-than-binary feet). As we shall see in Chapter 3, the proposed account will obtain the desirable effects of unbounded feet with stressless binary feet and the desirable effects of ternary feet with intersecting feet in gridmark sharing configurations. Allowing larger-than-disyllabic feet in the grammar would only make it less restrictive.

The second difference is that Ft-Bin's minimality restriction is absent in FootCap, and with the minimality restriction has gone the moraic restriction. Although minimal word

³ This is because a foot's being larger than disyllabic implies that it will also be larger than bimoraic, and a foot's being smaller than bimoraic implies that it will also be smaller than disyllabic.

⁴ The authors who originally advanced the formulation in (19) seemed to hold it apart somewhat from other violable constraints. Prince and Smolensky (1993) say that it "*excludes* the sogennant 'unbounded feet' of early metrical theory" (italics are mine); McCarthy and Prince (1993a) in discussing the ranking Ft-Bin >> Parse-Syll state that "this dominance relation is quite normal, and if universal, would entail that Ft-Bin should be incorporated into Gen"; and McCarthy and Prince (1993b) state that Foot Binariness "is responsible for the non-existence (or markedness) of degenerate feet". Although non-violability seems to be the tendency in these proposals, subsequent accounts have generally viewed the constraint as violable.

⁵ This is true even in versions of binarity like that of Hewitt 1994 where minimality and maximality are contained in separate constraints. (Hewitt's account also separates the syllabic and moraic restrictions.)

effects and the rarity of monomoraic feet generally might seem to motivate a specific minimality requirement on foot size, such a restriction proves unnecessary as there are already ample devices, available in the both the standard and proposed accounts, for obtaining these effects.

One device for obtaining minimality effects is alignment, a result of its preference for minimal structure. As we shall see in more detail in Chapter 3, there are two ways to reduce the number of feet in a form and thus reduce the number of alignment violations that a form incurs. The first is non-parsing of syllables, an option not available in the proposed account. The second is to make the feet larger. Consider the following possible footings for a six-syllable form:

(21) Fewer Feet through Larger Feet

$\sigma\sigma\sigma\sigma\sigma$	Align Left	Align Right
a. $(\sigma)(\sigma)(\sigma)(\sigma)(\sigma)(\sigma)$	* ** *** ****	* ** *** ****
b. $(\sigma\sigma)(\sigma\sigma)(\sigma\sigma)$	***** ** ****	***** ** ****
c. $(\sigma\sigma\sigma)(\sigma\sigma\sigma)$	***	***
d. $(\sigma\sigma\sigma\sigma\sigma)$		

As (21a) demonstrates, a single foot that includes every syllable is the most optimal parsing with respect to alignment. As the foot is divided into more and more feet, the number of violations increases. In the proposed account, the FootCap Condition excludes the ternary and unbounded feet of (21c, d), but notice the difference in the number of violations between (21a), the form parsed with monosyllabic feet, and (21b), the form parsed with disyllabic feet. The form with monosyllables incurs many more violations, as it must use twice

the number of feet to parse the syllables. A minimality effect arises from this phenomenon.⁶ Disyllabic feet are better than monosyllabic feet with respect to alignment.

Another pressure towards minimal binarity is *Clash, the constraint against clashing gridmarks. The requirement to avoid clash favors disyllabic or bimoraic feet over monomoraic feet. Consider the possible parsings for a six-syllable form below:

(22) Binarity through Clash Avoidance

σσσσσσ	*Clash
x x x x x x x x x x x x a. (L)(L)(L)(L)(L)(L)	*****
x x x x x x x x x x x x b. (L L)(L L)(L L)	
x x x x x x x x x x x x c. (L L)(L L)(L L)	
x x x x x x xx xx xx xx xx xx d. (H)(H)(H)(H)(H)(H)	

In (22a), we see that monomoraic feet either preceded or followed by a stress are in a clash configuration. Bimoraic feet, as in (22b-d), avoid clash configurations. This will be true in general, except in certain cases where the bimoraic feet are preceded or followed by a monomoraic foot. For example, if a monomoraic foot followed the string of iambs in (22b), or if a monomoraic foot were to intervene between any two iambs, this foot would create a clash configuration with the preceding iamb. If a monomoraic foot preceded the string of trochees in (22c), or if a monomoraic foot were to intervene between any two trochees, this foot would create a clash configuration with the following trochee. The same

⁶ It should be noted that alignment may also promote a maximal amount of structure. For example, to better satisfy alignment between feet and prosodic words, one possibility is to multiply the number of prosodic words so that there is one for each foot.

situation would hold with the heavy monosyllables in (22d). Being bimoraic, then, typically allows feet to avoid clash, but clash is always lurking when monomoraic feet are introduced.

Although these tendencies suggest that it is possible to do away with specific minimality restrictions on foot size, they only take us so far. Alignment and *Clash do not predict minimal word sizes in isolated forms. In a more speculative mode, however, it is worth mentioning that clash avoidance might have a minimal word effect on forms that are not in isolation. For example, take the three forms below each followed by a word with initial stress. (Square brackets indicate a prosodic word boundary).

(23) Clash with a Following Word

a. Clashing	b. Non-Clashing	c. Non-Clashing
$\begin{array}{cc} x & x \\ x & x \\ [(L)] & [(\sigma \dots)] \end{array}$	$\begin{array}{cc} x & x \\ xx & x \\ [(H)] & [(\sigma \dots)] \end{array}$	$\begin{array}{ccc} x & & x \\ x & x & x \\ [(L \ L)] & & [(\sigma \dots)] \end{array}$

Example (23a), where the form consists of a single light syllable, is in a clash configuration when immediately followed by a stressed syllable. Examples (23b), where the form consists of a single heavy syllable, and (23c), where the form consists of two light syllables with stress on the first, are not in clash configurations when immediately followed by a stressed syllable.

Pressure for disyllabicity could also come when one form follows another that has final stress.

(24) Clash with Preceding Word

a. Clashing	b. Non-Clashing
$\begin{array}{cc} x & x \\ x & x \\ \dots(\sigma)] & [(L \)] \end{array}$	$\begin{array}{ccc} x & & x \\ x & x & x \\ \dots(\sigma)] & [(L \ L \)] \end{array}$

Example (24a), where the form consists of a single light syllable, is in a clash configuration when immediately preceded by a stressed syllable. Example (24b), where the form consists of two syllables with stress on the second, is not in a clash configuration when immediately preceded by a stressed syllable.

This indicates that, at least in connected speech, clash avoidance could be a pressure towards minimal binarity in the word. Although the idea would be difficult to formalize, the shape of a word in connected speech might very well influence its shape in isolation. As the idea is just speculation at this point, and formalization would take us too far afield, I will not develop it further.

Not so speculative, however, are the more direct effects of NonFinality. I will discuss these in more detail in Chapters 4 and 5. For now, however, it is sufficient to point out that if stress cannot occur on the final syllable (either of the word or foot), then a word must have at least two syllables to be stressed at all, and if stress cannot occur on the final mora (either of the word or foot), then a word must have at least two moras to be stressed at all. A generalized account of NonFinality, such as the one to be proposed in Chapter 4, will have no difficulty in directly obtaining the majority of minimal word effects. When taken together, then, the effects of alignment, clash avoidance, and NonFinality create ample pressures towards minimality of both feet and words without stipulating a minimal foot size.

2.1.5 Summary

We have seen in the discussion of the prosodic hierarchy above that the proposed account abandons the Proper Bracketing condition of earlier accounts, allowing feet and other prosodic categories to intersect. We have also seen several specific conditions that the proposed account does apply to the prosodic hierarchy. These non-violable conditions were Strict Succession, Contiguity, Uniqueness of Domain, and FootCap. Strict Succession ensures exhaustive parsing of instances of one category level into instances of the next highest level. Contiguity ensures that there is no crossing of association lines without constituent sharing. Uniqueness of Domain ensures that no two categories of the same level may take up exactly the same space, and FootCap ensures that feet will be no larger than disyllabic.

2.2 Prosodic Prominence

The second major component of the theory is Prosodic Prominence, a system of prominence where some immediate constituent of a prosodic category is designated as the head, or the prominent constituent, of that category:

(25) Head Condition

For every prosodic category (> mora), there is some constituent immediately dominated by that category that is designated as its head.

As stated in (25), the proposed account does not take heads to be equivalent to entries on the metrical grid, nor are heads necessarily even associated with gridmark columns.

The head of a prosodic category is always one of the constituents of that category. The head of a syllable is the prominent mora within that syllable, the head of a foot is the prominent syllable within that foot, and the head of a prosodic word is the prominent foot within that prosodic word. Which constituent of a category is designated as its head may be determined in several ways. The head of a foot, for example, may be positioned so as to better satisfy foot-head alignment constraints; it may correspond to some intrinsic syllabic prominence, such as weight; or it may correspond to some gridmark column. This all depends, of course, on the ranking of the relevant constraints, constraints that will be discussed in more detail as we proceed.

Perhaps the most important feature of prosodic prominence is its conceptual and formal separation from entries on the metrical grid. The vowel reduction phenomenon in Dutch offers important evidence supporting this separation.⁷ In particular, it provides evidence for the existence of prosodic heads which do not correspond to gridmark columns. The phenomenon itself is fairly complex. For example, ease of reduction depends on the type of vowel involved. The vowels /y/ and /u/ strongly resist reduction, but /e/ reduces quite easily. Register of speech also affects the possibility of reduction. Vowels reduce with greater ease in less formal registers.

⁷ Thanks to Ben Hermans for pointing out the possibility of this analysis.

The aspect of reduction that we are primarily interested in here, however, is the significance of the position of the syllable in which the vowel occurs. Kager's (1989) analysis gives a detailed description of the phenomenon and summarizes previous approaches. I will not go into such detail here but will only touch on the most relevant points. In general, vowels in stressed syllables may not reduce, but vowels in unstressed syllables resist reduction to varying degrees depending on the syllable's position in the form. For example, the second /a/ in *àbracadábra* reduces more easily than the third, and the second /o/ in *fònologíe* reduces more easily than the third.

In Kager's analysis, these unstressed medial positions are divided into two types, "stray" and "adjunct", based on the structures he posits. Adjunct syllables, labeled "A" in the illustration below, are those which are included in a foot. Stray syllables, labeled "S" in the illustration below, are those which are not included in a foot:

(26) Stray and Adjunct in Dutch (Kager 1989)

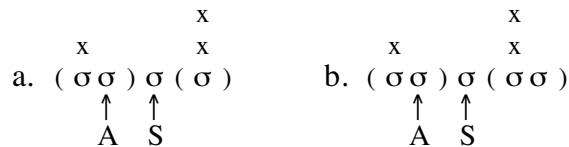

Example (26a) is a four-syllable form, representing a word like *fonologie*, with secondary stress on the first syllable and main stress on the fourth syllable. The second syllable is included in a foot, so it is an adjunct syllable. The third syllable is not included in a foot, so it is stray. Example (26b) is a five-syllable form, representing a word like *abracadabra*, with secondary stress on the first and main stress on the fourth. The second syllable is included in a foot, so it is an adjunct. The third syllable is not included in a foot, so it is stray.

The following chart, adapted from Kager 1989, summarizes the potential for reduction of individual vowels with respect to both register of speech and the position of the syllable in which they are included. The register indicated is the highest register where reduction is possible. Reduction may occur in this and all lower registers.

(27) Vowel Reduction Summary

<u>Vowels</u>	<u>Adjunct</u>	<u>Stray</u>
e	formal	formal
a	less formal	less formal
o, i	less formal	informal
y, u	informal	excluded

The vowel /e/, for example, may reduce in both positions in any register, including the formal. The vowels /o/ and /i/, however, may not reduce in the formal register but may reduce in adjunct positions in the less formal and informal registers and in stray positions in the informal register.

Notice that it is the stray syllables in Kager's analysis that are least susceptible to reduction. This circumstance seems counter-intuitive under the more recent Optimality Theoretic view of faithfulness based on positional prominence (see Alderete 1995 and Beckman 1998), where the most prominent syllables should be the ones least likely to allow reduction. Stressed syllables are more prominent than other syllables and are reasonably the objects of positional faithfulness constraints, but of the unstressed syllables, the footed syllables would seem to have more claim to positional prominence than the unfooted syllables.

Unfooted, unstressed syllables are, after all, just plain ordinary syllables, and from a practical standpoint this offers the difficult problem of how a faithfulness constraint could refer to them without referring to every other syllable as well. The prospect of actually introducing the designation "stray" as a formal property of syllables, especially a property that carries with it a degree of prominence, is unappealing to say the least. It is also a problem that, under the proposed account, stray syllables simply do not exist. All syllables are necessarily footed, doing away completely with any distinction that might be framed in terms of stray and adjunct.

The proposed account, however, using the idea that prosodic heads are not necessarily associated with gridmarks, can capture the three-way distinction that Dutch requires in a way that is more in line with the principles of positional faithfulness. Syllables that are heads and stressed would be most prominent and would resist reduction. Syllables that are

unstressed heads would be less prominent and more likely to reduce. Syllables that are neither stressed nor heads would be least prominent and the most likely to reduce. The structures in (28) would replace those from (26).

(28) Heads and Stressed Syllables

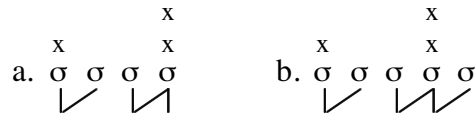

In (28a), the four-syllable form is parsed by three feet. The first syllable is the head of the first foot, and it is stressed. The final two feet, one disyllabic and one monosyllabic, form an intersecting configuration. The third syllable is the head of the disyllabic foot, and the fourth syllable is the head of the monosyllabic foot. Only the head of the monosyllabic foot is stressed. The difference between the second and third syllables is now that the third syllable is a head and the second is not. Under this account, then, there is a prominence-based reason to be more faithful to the third syllable than the second. In (28b), the five-syllable form is also parsed by three feet. The initial syllable is the head of the first foot, and it is stressed. The final two feet, both disyllabic this time, form an intersecting configuration. The third syllable is the head of the first foot in the intersection, and the fourth syllable is the head of the second foot. Only the head of the second foot is stressed. The same reason as in (28a) for being more faithful to the third syllable than to the second holds. The third syllable is a head, but the second is not.

The possibilities for reduction of the individual vowels in the proposed account, with respect to both register of speech and the status of the syllables in which they occur, can be summarized as follows:

(29) Summary of Reduction in the Proposed Account

<u>Vowels</u>	<u>Syllable</u>	<u>Head</u>	<u>Stressed Head</u>
e	formal	formal	excluded
a	less formal	less formal	excluded
o, i	less formal	informal	excluded
y, u	informal	excluded	excluded

Without going into great detail, the proposed account's three-way prominence distinction can easily be incorporated into a system of positional, or prominence-based, faithfulness constraints. Stressed heads are more prominent than heads generally, and heads are more prominent than syllables generally. There might be faithfulness constraints that refer to each level of the distinction: faithfulness to stress, faithfulness to heads, and faithfulness to syllables.

In order for the effects of each type of faithfulness to be manifest, as they are in Dutch, the constraints would have to be ranked in order of their specificity.⁸ In order to be more faithful to stressed heads than to heads generally, Faith-Stress would have to rank above Faith-Head, and in order to be more faithful to heads than to syllables generally, Faith-Head would have to be ranked above Faith-Syllable. The resulting ranking is Faith-Stress >> Faith-Head >> Faith-Syllable.

As stressed syllables never allow reduction, Faith-Stress would always have to dominate any markedness constraint promoting reduction, whatever the register of speech. The rankings, however, of Faith-Head and Faith-Syllable with respect to markedness constraints depend on the vowel and the register of speech. For example with respect to the vowels /o/ and /i/, the markedness constraints against them would have to be ranked below Faith-Syllable in the formal register, preventing them from reducing in all syllables; between Faith-Head and Faith-Syllable in the less formal register, preventing them from reducing in heads but not in ordinary syllables; and above Faith-Head in the informal register, preventing them from reducing in stressed heads but not in unstressed heads or ordinary syllables.

To summarize, the proposed account posits a system of prosodic prominence distinct from the type of prominence represented by the metrical grid. Prosodic prominence is represented by the designation "head", a designation obligatorily assigned to some constituent of every prosodic category. As evidence supporting this formulation, we saw how the formal separation of prosodic heads from gridmarks and the possibility of heads that do

⁸ See the discussion of Panini's Theorem on Constraint Ranking in Prince and Smolensky 1993.

not correspond to gridmark columns helps to capture the restrictions on Dutch’s vowel reduction phenomenon.

2.3 The Metrical Grid

The third major component of the proposal is the Metrical Grid, introduced to linguistic theory in Liberman 1975. There are two primary motivations for its inclusion. The first is Liberman’s conception of the grid as representing the intuited structure of time based on its division into points and its organization into “hierarchically-related periodicities”. In Liberman’s account, the conceptual justification for the grid in language was that it measured time in a way parallel to which it is measured in music, an appealing notion from the standpoint of their common rhythmic orientation.

For a formal definition of grid structure in terms of an ordered set of ordered sets, the reader is referred to Liberman’s account. On an intuitive level, however, the grid is organized linearly into a series of pulses representing points in time:

(30) Pulses Represent Points in Time

x x x x x x x x

The grid is further organized hierarchically by adding layers of pulses with different periodicities:

(31) Hierarchical Organization

x		x		level 2				
x	x	x	x	level 1				
x	x	x	x	x	x	x	x	level 0

In (31), an illustration of 2/4 time, one pulse occurs on level 1 for every two pulses on level 0, and one pulse occurs on level 2 for every two pulses on level 1 and every four pulses on level 0. The first column of the grid has one-beat, two-beat, and four-beat pulses. The second column has only a one-beat pulse, and the third column has a one-beat and a two-beat pulse, and so on. The tallest columns, the points where gridmark periodicities intersect most frequently, are the most prominent. The shortest columns, where gridmark periodicities intersect least frequently, are the least prominent. Prominence here refers to the prominence of

time. Points in time corresponding to taller columns are more prominent than points in time corresponding to shorter columns.

A well-formedness condition on the grid's hierarchical organization, typically assumed in all theories of the metrical grid,⁹ is a Continuous Column condition, which I take to be universal and non-violable:

(32) Continuous Column Condition

All gridmarks above the base level must be entered over a gridmark from the next level down.

This condition prevents grid configurations where a gridmark seems to be dangling out in space with nothing to support it:

(33) Discontinuity in Grid Columns

	x				level 2
x				x	level 1
x	x	x	x	x	level 0

Grid layers— except for the base layer— must always be built with reference to the next level down. The level of reference for level 1 is level 0, the level of reference for level 2 is level 1, and so on. Gridmarks from level 2 cannot, as in (33), be entered directly over gridmarks from level 0.

The second motivation for the grid comes from Liberman and Prince 1977, which justifies the grid in terms of its ability to provide a workable formalism for the idea of “clashing” stresses, a configuration where prominences are “too nearly adjacent”. In their proposal, Liberman and Prince introduce the notion of clash as part of an account of Rhythm Rule phenomena, phenomena where internal stress relations are adjusted under embedding. Liberman and Prince take clash to be a configuration where two place holders (gridmarks) on the same level have no intervening place holders on the next level lower:

⁹ See Prince 1983 and Hayes 1995 for discussion.

(34) Clash and Non-Clash

Clashing

a. x x x x x x x	b. x x x x x x x x x
-----------------------------	---

Non-Clashing

c. x x x x x x x	d. x x x x x x x x x x
-------------------------------	--

In example (34a), the two gridmarks on level 1 have no intervening entry on level 0. Compare this to example (34c). Here, the two gridmarks on the level 1 do have an intervening entry on level 0. Example (34a), then, contains clash, but (34c) does not. In example (34b), the two gridmarks on level 2 have no intervening entry on level 1. The two gridmarks on level 2 in (34d), however, do have an intervening entry on level 1. Example (34b) contains clash, but (34d) does not.

In this way, the grid captures elegantly not merely adjacency of stress but also adjacency of degrees of stress. For example, the two grids below both have columns aligned over the second and fourth syllables:

(35) Adjacent Degrees of Stress

a. Non-Clashing x x x x x x x σ σ σ σ σ	b. Clashing x x x x x x x x x σ σ σ σ σ
---	---

In both examples, there is a single position separating the two columns. In (35a), the columns only have a height of level 1, and as there is an intervening entry one level down, they are not in clash— not “too nearly adjacent”. In (35b), however, the columns have a height of level 2. With this degree of prominence, there is no intervening entry one level down, and the degrees of stress are “too nearly adjacent”. The grid’s ability to formally capture this type of clash gives it an important edge over systems that do not capture it so easily (such as those based on stress features, whether binary or *n*-ary, as in Chomsky and Halle 1968).

As we saw in Chapter 1, the principle of clash avoidance is a central aspect of the proposed account. It was incorporated into a violable constraint, repeated in (36) below, based on earlier definitions of clash.

(36) *Clash (adapted from Prince 1983)

For any two gridmark entries on level n ($n \neq 0$), there is an intervening entry on level $n - 1$.

Recall that clash avoidance is one of the primary motivations for both the introduction of intersecting prosodic categories and the modification of the foot-stress relationship.

Having separated heads from gridmarks in the proposed account, it is important to note that the definition in (36) refers only to gridmark entries and not to the heads that they may be associated with. Adjacent foot-heads, for example, as in the configuration in (37), do not create a clash configuration.

(37) Adjacent Heads

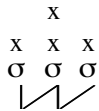

In (37), three syllables are parsed using two intersected trochees, a foot-level gridmark occurring in the intersection. Although the heads of the two feet are adjacent, there is no clash configuration because there are no two gridmark entries that would not have an intervening entry one level down.

We have now examined the first three components of the theory: the prosodic hierarchy, prosodic prominence, and the metrical grid. We have also seen some of the conditions and constraints that govern their internal organization. In the next few sections, we will see some of the conditions and constraints that govern relations between them.

2.4 Prosodic Hierarchy-Prosodic Prominence Interaction

There are strong connections between the prosodic hierarchy and the system of prosodic prominence, as the latter is defined in terms of the former. The primary connection, stated in the Head Condition in (25), is simply that every prosodic category designate one of its im-

mediate constituents as its head. There are two basic restrictions, however, that the proposal will place on this relationship.

(38) Uniqueness of Head to Domain

Each prosodic category may designate one and only one constituent as its head.

(39) Uniqueness of Domain to Head

Each constituent may receive the designation “head” from one and only one prosodic category.

I take both (38) and (39) to be non-violable conditions on Gen., so that forms which violate them cannot be considered as output candidates.

The first condition, Uniqueness of Head to Domain, ensures that each prosodic category has a single head. There are no categories that designate two, three, or more heads. The following doubly headed foot, for example, is not possible in the theory:

(40) Doubly Headed Foot

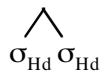

The designation of prominence that accompanies headship, coupled with the limitation of categories to a single head, should be taken to entail that the head is the single most prominent member of any given prosodic category.

The second condition, Uniqueness of Domain to Head, ensures that prosodic categories do not share heads. The head of one foot, for example, cannot also be the head of a second foot. Although this is a general condition on prosodic categories themselves, it only truly becomes relevant in intersected structures. As heads are specially designated constituents of prosodic categories, sharing a head is only possible where sharing constituents is possible. The condition prohibits, then, the intersecting configuration below where the second syllable is the head of both the first and second foot:

(41) Sharing a Head

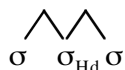

This is not to say that the head of one foot may not occur within the domain of another. It only means that a shared syllable may not be the head of both feet. The types of configurations below are freely allowed:

(42) Intersecting Feet with Unique Heads



In (42a), the second syllable is shared by two feet. This syllable happens to be the head of the second foot, but it is not the head of the first. The head of the first foot is the first syllable. In (42b), the shared syllable is the head of the first foot, but it is not the head of the second. The head of the second foot is the third syllable. In (42c), the shared syllable is the head of neither foot. The head of the first foot is the first syllable, and the head of the second foot is the third syllable.

2.4.1 The Weight-to-Head Constraint

Having separated gridmarks entries from headedness, it is necessary to decide which of the two systems, the Metrical Grid or Prosodic Prominence, traditional principles like clash avoidance, lapse avoidance, and Weight-to-Stress refer to. As we saw in Section 2.3 above, the *Clash constraint retains its reference to gridmarks, as was originally intended. Lapse avoidance and Weight-to-Stress, however, will both refer to the heads of feet, rather than to the gridmark entries that may be associated with them.

The Weight-to Stress Principle of Prince 1991 is reformulated as the Weight-to-Head Constraint in (43) below.

(43) Weight-to-Head Constraint

Every heavy syllable must be designated as the head of some foot.

Notice that, as formulated in (43), the Weight-to-Head Constraint does not demand that heavy syllables be stressed (associated with gridmark entries) but only demands that heavy syllable be designated as the heads of feet. Either of the configurations (44a) or (44b), then, would satisfy the constraint, but the configuration in (44c) would not.

(44) Weight-to-Head

a. Satisfaction



b. Satisfaction



c. Non-Satisfaction



In (a), the heavy syllable is the head of an iambic foot. Although the syllable is not associated with a foot-level gridmark, all that is required is that it be a head. In (b), the heavy syllable is again the head of an iambic foot, but this time the syllable is also associated with a foot-level gridmark. The configuration satisfies the constraint but not because the syllable is stressed. The only relevant fact is that the syllable is a head. In (c), the heavy syllable is the non-head of a trochaic foot. Since the heavy syllable is not a head, the configuration would violate the constraint.

Evidence for the formulation in (43) comes from languages like Seminole/Creek (Haas 1977, Jackson 1987, and Tyhurst 1987) and Cairene Arabic (Mitchell 1960, McCarthy 1979), where heavy syllables affect foot and stress patterns without necessarily being stressed themselves. In Seminole/Creek, for example, stress prefers to fall, first, on a heavy ultima and, second, on a heavy penult. The cases that interest us here, however, are those where neither the ultima or penult is heavy. In such cases, stress will fall on the light ultima or penult, whichever happens to be an odd number of syllables from the beginning of the word, as in (45a), or the last heavy syllable, as in (45b).

(45) Seminole/Creek Forms (from Hayes 1995)

- | | | | |
|----|--------|------------|----------------------------|
| a. | LLĹ | apataká | <i>pancake</i> |
| | LLĹLL | am-apatáka | <i>my pancake</i> |
| b. | LHĹLL | tokoħokíta | <i>to run (dual subj.)</i> |
| | HLLĹ | iŋkosapítá | <i>one to implore</i> |

The basic pattern of Seminole/Creek is illustrated by the forms in (45a), which contain only light syllables. In even-parity forms, such as /apataká/, stress occurs on the ultima, and in

odd-parity forms, such as /am-apatáka/, stress occurs on the penult. The effect of heavy syllables is illustrated by the forms of (45b). If heavy syllables are in phase with the basic pattern, as in /tokołhokíta/, the basic pattern remains, but if heavy syllables are not in phase with the basic pattern, as in /iŋkosapítá/, stress will shift to the adjacent syllable (in this case from the penult to the ultima).

In the proposed account, the basic pattern would be based on rightward foot-head alignment (rightward iambic footing). Primary stress would occur within the final foot, the head foot of the prosodic word. Within the final foot, as we shall see in more detail in Section 2.5 below, stress will occur within an intersection if one is available, as in (46a), otherwise over the head of the final foot, as in (46b).

(46) The Basic Pattern

a. Even-Parity

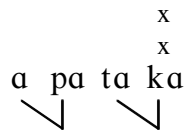

b. Odd-Parity

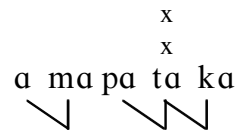

The perturbations due to heavy syllables can be obtained simply by ranking the Weight-to-Head constraint over rightward foot-head alignment. By forcing heavy syllables to be heads, although not stressed, the grammar forces the count to start over after heavy syllables. If the remaining syllables are odd-parity, there will be an intersection within the final foot and stress will occur within the intersection. If the remaining syllables are even-parity, as demonstrated using /iŋkosapítá/ below, there will be no intersection, and stress will occur on the head syllable of the final foot.

(47) Weight-to-Head >> Hds-Right

iŋkosapita	Weight-to-Head	Hds-Right
a. iŋ ko sa pi ta \ \ / \ x x		** ****
a. iŋ ko sa pi ta \ \ / \ x x	*!	* ****

In (47), the (b) candidate exhibits the best possible rightward foot-head alignment given the length of the form. To achieve this configuration, however, the initial heavy syllable must be a non-head, so that candidate (b) violates Weight-to-Head and drops out of consideration. Although designating its heavy syllable as the head of the initial foot causes candidate (a) to have more violations of rightward alignment than (b), it also allows (a) to satisfy Weight-to-Head, and, given the ranking, to emerge as the winner.

2.4.2 The Lapse Condition

One further restriction on interaction between the prosodic hierarchy and the prosodic prominence system is the non-violable Lapse Condition, introduced in Chapter 1 and repeated in (48) below.

(48) Lapse Condition

For every two adjacent syllables, one must be a foot-head.

The Lapse Condition limits the different configurations of foot-types that a single form might have. In particular, it excludes forms where an iambically headed foot follows a trochaically headed foot, the type of configuration where two non-head syllables would be adjacent, as the two unattested alternations in (49) illustrate.

(49) Banned Configurations

a. Trochee Followed by Iambs

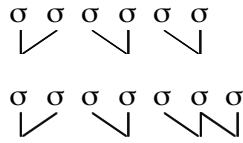

b. Iamb Preceded by Trochees

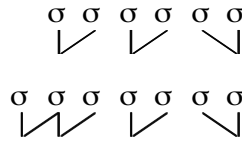

The alternation in (49a) is, for example, the foot pattern that would be preferred by the ranking PrWd-L >> Hds-Right if the Lapse Condition were not in effect, and the alternation in (49b) is the foot pattern that would be preferred by the ranking PrWd-R >> Hds-Left if the Lapse Condition were not in effect.

The separation of heads from gridmark entries is significant in the formulation of this condition as well. Since the Lapse Condition refers to heads and not to the gridmark columns that may be associated with them, there is a restriction on the maximum distance that may occur between foot-heads but not on the maximum distance that may occur between gridmarks. Although the configurations in (50) both exhibit adjacent stressless syllables, neither violates the Lapse Condition.

(50) Irrelevance of Gridmark Positions

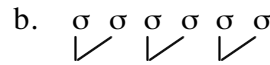
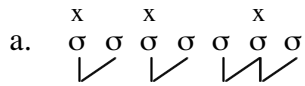

In (50a), seven syllables are parsed using trochaic feet, and an intersection occurs at the right edge. The absence of a gridmark column over the second head from the right creates a string of two stressless syllables preceding the penult. Because there are never two adjacent non-head syllables, however, the configuration satisfies the Lapse Condition. In (50b), six syllables are parsed using three stressless trochaic feet. Although the entire string of syllables is stressless, there are never two adjacent non-head syllables, and the configuration satisfies the Lapse Condition.

At first glance, it might seem that I introduced the Lapse Condition in an *ad hoc* fashion in Chapter 1 to avoid the particular cases in (49). The necessity of a condition like the Lapse Condition, however, actually arises from two very general properties of the pro-

positional: the reliance on foot-head alignment to position feet and the ability to fix the position of some foot-head in such a way that it is “out of phase” with alignment. To this point in the discussion, the only mechanism for positioning foot-heads out of phase with foot-head alignment is prosodic word alignment, but I will discuss several others in the chapters that follow, among these faithfulness to an underlying stress and the necessity of allowing a heavy syllable to be a head.

Suppose, for example, that some heavy syllable is out of phase with leftward foot-head alignment, as in (51a), or out of phase with rightward foot-head alignment, as in (51b), and suppose further that a high ranking Weight-to-Head constraint demands that this syllable be the head of a foot:

(51) Out of Phase Heavy Syllables

a. Out of Phase with Hds-Left



b. Out of Phase with Hds-Right

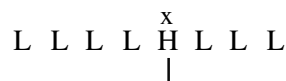

Without a restriction like the Lapse Condition, leftward foot-head alignment for a form like (51a) will produce a configuration like (52a), and rightward foot-head alignment for a form like (51b) will produce a configuration like (52b). These forms exhibit the configuration where an iamb follows a trochee, the configuration that the Lapse Condition targets.

(52) Alignment without the Lapse Condition

a. Hds-Left

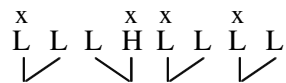

b. Hds-Right

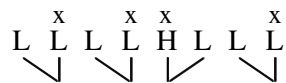

The types of stress patterns that these configurations exhibit are not problematic in all cases, but they are problematic when produced with the indicated alignment constraints.

To illustrate more clearly, it will help to compare the proposed account with earlier derivational approaches. Leftward foot-alignment in the proposed account corresponds to Right to Left trochaic iteration in earlier derivational accounts, and rightward foot-head alignment corresponds to Left to Right iambic iteration. If we were to produce the types of

patterns in (52) with these derivational mechanisms it would mean skipping a syllable after a heavy syllable before resuming iteration:

(53) Skipping a Syllable in Iteration

- a. Right to Left Trochaic b. Left to Right Iambic
- $$(\overset{x}{L}L)L(\overset{x}{H})(\overset{x}{L}L)(\overset{x}{L}L) \qquad (L\overset{x}{L})(L\overset{x}{L})(\overset{x}{H})L(L\overset{x}{L})$$

In (53a), corresponding to (52a), leftward iteration of trochees skips the syllable preceding the heavy syllable, and in (53b), corresponding to (52b), rightward iteration of iambs skips the syllable following the heavy syllable.

Now consider the patterns of (52) and (53) in connection with the configurations that the indicated alignment or iterative directionality would produce for an odd-parity string of light syllables:

(54) Comparison with Odd-Parity String: Foot-Head Alignment

- a. Hds-Left b. Hds-Right
- $$\begin{array}{ccc} \overset{x}{L} & \overset{x}{L} & \overset{x}{L} \\ \swarrow & \swarrow & \swarrow \\ L & L & L \end{array} \qquad \begin{array}{ccc} \overset{x}{L} & \overset{x}{L} & \overset{x}{L} \\ \swarrow & \swarrow & \swarrow \\ L & L & L \end{array}$$
- $$\begin{array}{ccc} \overset{x}{L} & \overset{x}{L} & \overset{x}{L} \\ \swarrow & \swarrow & \swarrow \\ L & L & L \end{array} \qquad \begin{array}{ccc} \overset{x}{L} & \overset{x}{L} & \overset{x}{L} \\ \swarrow & \swarrow & \swarrow \\ L & L & L \end{array}$$

(55) Comparison with Odd-Parity String: Iteration

- a. Right to Left Trochaic b. Left to Right Iambic
- $$L(\overset{x}{L}L)(\overset{x}{L}L)(\overset{x}{L}L) \qquad (L\overset{x}{L})(L\overset{x}{L})(L\overset{x}{L})L$$
- $$(\overset{x}{L}L)L(\overset{x}{H})(\overset{x}{L}L)(\overset{x}{L}L) \qquad (L\overset{x}{L})(L\overset{x}{L})(\overset{x}{H})L(L\overset{x}{L})$$

Pairs like those in (54) and (55) apparently do not occur in the same language. With leftward trochaic footing, as in (54/55a), we would expect one but not two unstressed syllables preceding a heavy syllable, and with rightward iambic footing, as in (54/55b) we would expect one but not two unstressed syllables following a heavy syllable.

Regardless of the theory under consideration, systems like those illustrated in (54) and (55) would be problematic, and a successful theory must have a means of avoiding

them. In derivational accounts, the means of avoiding systems like (55) is typically an insistence in such cases on local parsing (see, for example, Hayes 1995). Iterative footing cannot skip syllables that can be included in a well formed foot. In the proposed account, the means of avoiding configurations like (54) is the Lapse Condition, which bans these types from consideration as output candidates, leaving room for patterns like (56) to fill the void.

(56) Alignment with Lapse Condition

a. Hds-Left

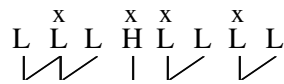

b. Hds-Right

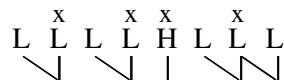

Although these structures are not aligned as well as their (54) counterparts, they do not contain lapse configurations and are therefore legitimate output candidates. We will encounter other similar cases as we proceed.

In this section, then, we have seen some restrictions on the possible relationships between the prosodic hierarchy and the system of prosodic prominence. First, we examined two restrictions on the relationship between a prosodic category and its head. The Uniqueness of Head to Domain Condition demanded that no more than one constituent be designated as the head of any one prosodic category, and the Uniqueness of Domain to Head Condition demanded that no two prosodic categories designate the same constituent as their head. We also examined the Weight-to-Head constraint, which demands that heavy syllables be designated as the heads of feet, and the Lapse Condition, a non-violable condition restricting the maximum distance between foot-heads.

2.5 Metrical Grid-Prosodic Prominence Interaction

We saw in Chapter 1 that there is a close relationship between prosodic categories and entries on the metrical grid. The primary mechanism for establishing this relationship, however, the MapGridmark constraints, say only that a gridmark occurs within the domain of a prosodic category. They say nothing about the question of where exactly in the domain of

the prosodic category the gridmark occurs. The answer to this question actually lies in an interaction between the Metrical Grid and the system of prosodic prominence, an interaction that is captured in the non-violable condition in (57):

(57) Gridmark to Head Condition

Every PCat-level gridmark occurs within the domain of a head at each level of the prosodic hierarchy \leq PCat.

As stated in (57), the Gridmark to Head Condition requires that every gridmark associated with some prosodic level occur within the domain of a head at that level and at each lower prosodic level.

To make this requirement a little clearer, it will be helpful to consider a few examples. First consider below three possible locations for a foot-level gridmark within the domain of a single non-intersected foot. In (58), the first mora of the second syllable is its head, and the second syllable is the head of the foot.

(58) Non-Intersected Foot

a. Not Permitted



b. Not Permitted



c. Permitted

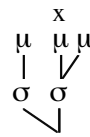

In (a), the foot-level gridmark occurs over the foot's first syllable. Since this syllable is not a head, the gridmark does not meet the Gridmark to Head Condition, and (a) is not a possible output candidate. In (b), the foot-level gridmark occurs over the second syllable. Since the second syllable is the head of the foot, the gridmark conforms to the condition at this level. Within the syllable, however, the gridmark occurs over the second mora. Since this mora is not a head, the gridmark fails the condition, and (b) is not a possible output candidate. Only in (c), where the gridmark occurs over both the head of a foot and the head of a syllable, is the Gridmark to Head Condition met.

Next, consider three possible locations for a foot-level gridmark in a string of three light syllables parsed by two intersected feet. In (59) the head of the first foot is the second syllable and the head of the second foot is the third syllable:

(59) Intersected Feet

a. Not Permitted

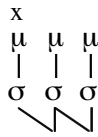

b. Permitted

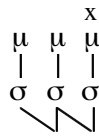

c. Permitted

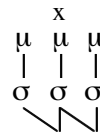

In (59), since each of the syllables is light, positioning the gridmark over the head mora is the only option, and the gridmark's position within the syllable is not an issue. In (a), the gridmark occurs over the non-head syllable of the first foot and fails the Gridmark to Head Condition. In (b), the gridmark occurs over the head of the second foot and conforms to the condition. In (c), the gridmark occurs over the syllable in the intersection. Although this syllable is the non-head of the second foot, it is also the head of the first foot. The gridmark conforms to the condition here as well. Example (a), then, is the only one of the three that is not a possible output candidate.

Finally, consider the case of a prosodic word-level gridmark. In (60) below, the three syllables of a prosodic word are parsed using two intersected feet. The second syllable is the head of the first foot, and the third syllable is the head of the second foot. The second foot is the head of the prosodic word:

(60) Prosodic Word Level

a. Not Permitted



b. Permitted

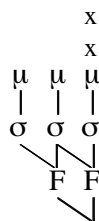

c. Permitted

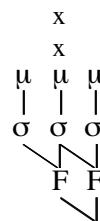

In (60), each of the syllables is light, so the position of the gridmark within the syllable is not an issue. In (a), foot and prosodic word level gridmarks occur over the first syllable. The

prosodic word level gridmark fails the Gridmark to Head condition because it is not within the domain of the head foot and also not within the domain of a head syllable. The foot-level gridmark also fails the condition because it is not within the domain of a head syllable. In (b), both gridmarks satisfy the condition. The prosodic word level gridmark occurs within the domain of both a head foot and a head syllable, and the foot-level gridmark occurs within the domain of a head syllable. In (c) as well, both gridmarks satisfy the condition. The prosodic word level gridmark occurs within the domain of both a head foot and a head syllable, and the foot-level gridmark occurs within the domain of a head syllable.

An interesting point about the Gridmark to Head Condition illustrated by (60c) is that the Gridmark to Head Condition does not always require the prosodic word level gridmark to be associated with the head syllable of the head foot. Although this will certainly be the requirement in non-intersected configurations, it need not be the case in configurations like (60) where the head of a second foot occurs within the head foot. Although this circumstance may seem slightly counter-intuitive at this point, the possibility is crucial to the success of the analysis.

For the analysis of Seminole/Creek discussed above to succeed, for example, there must be some flexibility with respect to the position of the prosodic word-level gridmark within the head of the prosodic word. As mentioned above, the head of the prosodic word in Seminole/Creek is the final foot. Within the head foot, stress occurs within an intersection if one is available and over the head syllable (the final syllable) of the head foot if one is not. The general location of the stress can be obtained by aligning the head foot to right of the prosodic word. Given the Gridmark-to-Head condition, this restricts primary stress to the final foot, but it does not necessarily pinpoint the location of stress within the foot, often leaving this determination up to other considerations.

In a case like /apataká/, where the head foot is non-intersected and its foot-head is the only foot-head available, stress must occur on the final syllable:

(61) Non-Intersection

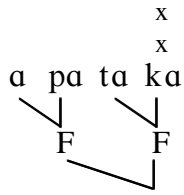

In a case like /am-apatáka/, however, where the head foot is intersected and there is another foot-head available for the location of primary stress, additional considerations, such as the MapGridmark constraint, must decide the location. As (62) demonstrates, positioning primary stress over the syllable in the intersection— the penult— allows for better satisfaction of MapGridmark without violating rightward alignment of the prosodic word-head or the Gridmark-to-Head Condition:

(62) Hd-Right, MapGridmark

am-apataka	Hd-Right	MapGridmark
		*
		**!

In (62), both candidates exhibit rightward iambic footing in accordance with the analysis discussed above. Both candidates also have optimal rightward alignment of the prosodic word-head and conform to the Gridmark-to-Head condition. The difference between them is that candidate (b) locates primary stress over the head syllable of the head foot where candidate (a) locates stress over the head syllable of the penultimate foot, the syllable in the intersection. Because the gridmark sharing configuration of candidate (a) allows it to perform

better than candidate (b) with respect to MapGridmark, candidate (a) correctly emerges as the winner.

2.6 Prosodic Hierarchy-Metrical Grid Interactions

The interactions of the metrical grid and the prosodic hierarchy are substantial in the proposed account, as the grammar constructs the grid by mandating that gridmarks be entered to correspond to prosodic categories. The size of these categories and the positions of their heads are the primary factors in determining the grid's configuration. For example, if gridmarks correspond to feet and the size of feet is two syllables, then there will typically be a single foot-level gridmark for every two syllables. If the theory allowed feet with three syllables, then there would typically be a single foot-level gridmark for every three syllables. Exactly which of a foot's syllables are candidates for association with grid entries is determined by the head's position within the foot, as required by the Gridmark to Head Condition.

2.6.1 Gridmark Mapping

In the proposed account, two types of requirements associate prosodic categories with gridmarks. The first, I take to be universal and non-violable:

(63) Head Mora Condition

A gridmark is entered on the base level of the grid corresponding to the head of every syllable.

The Head Mora condition establishes the grid's minimal base level by mandating that every mora that is the head of a syllable be associated with a gridmark entry. The qualification "minimal" here is significant, as it will be possible to map moras other than head moras to grid's base level.

The second type of requirement, which can establish higher levels for the grid as well as add to the base level, is actually a family of violable constraints:

(64) MapGridmark (PCat)

A gridmark of the appropriate level falls within the domain of every PCat, where PCat \neq Syll.

There is a particular constraint of this generalized form for every prosodic category except the syllable. I will examine each of these in detail below, but before moving on, the phrase “appropriate level” requires some additional attention. The appropriate level for entries corresponding to moraic domains is the base level, the appropriate level for entries corresponding to podal domains is the next level higher, the appropriate level for entries corresponding to prosodic word domains is the next level higher, and so on. In this sense, we can speak loosely of mora-, foot-, and prosodic word-levels of the grid, as I have in earlier parts of the proposal. The point of the “appropriate level” restriction in (64), then, is to prevent the satisfaction of MapGridmark (Ft) for some foot, for example, by a mora-level gridmark that occurs within its domain. The satisfaction of MapGridmark (Ft) must involve a foot-level gridmark.

2.6.2 The Base Level

As stated in (64), the MapGridmark family of constraints does not include a constraint for syllables. Syllables themselves do not map to the grid. This might seem like a peculiar omission, but to my knowledge, there has never been a theory where moras and syllables simultaneously map to the grid in a single language. The potential for this situation becomes a real concern in Optimality Theory if both moraic and syllabic versions of the constraint exist, because it would be possible to satisfy both simultaneously.

In earlier approaches, theories of gridmark mapping fall into one of two categories. The first is one where either syllables or moras may map to the grid, but not both, as in Kager 1993. Under this type of theory, there can be significant differences in the results that the two types of mapping obtain, particularly in the treatment of heavy syllables. Under syllabic mapping, heavy syllables correspond to only one gridmark, but under moraic mapping, they correspond to two. This difference has substantial import for issues like quantity sen-

sitivity and clash avoidance. The second type of theory is one where only syllables map to the grid, as in Prince 1983, but even in Prince’s account something like moras had to be taken into consideration. Prince posited a parametric option of “bipositional” mapping for heavy syllables, where they would correspond to two entries on the lowest level of the grid.

Although syllables may not map directly to the grid in the proposed account, we will still be able to obtain the effects of both moraic and syllabic mapping. In establishing the grid’s base level, the non-violable Head Mora Condition ensures that at least head moras will correspond to gridmark entries. If no further entries are added to the mora-level, then there will be one entry per syllable, an effective syllabic mapping. If further entries are added to the mora-level to meet the demands of MapGM (Mora), a particular instantiation of (64) stated in (65), then there will be one entry per mora, and moraic mapping will be established.

(65) MapGM (Mora)

A mora-level gridmark occurs within the domain of every mora.

Although there might be several considerations that could prevent moraic mapping through the violable MapGM (Mora), I will go into none in detail at this point. As we shall see in Chapter 3, however, alignment will be the primary mechanism utilized.

The grammar obtains the effects of syllabic, or monopositional, mapping when MapGM (Mora) ranks sufficiently low that the only moras mapped to the grid are those required by the non-violable Head Mora Condition. Example (66a) illustrates this type of mapping for a heavy syllable.

(66) Monopositional vs. Bipositional Mapping

a. Monopositional

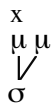

b. Bipositional

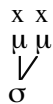

The grammar obtains the effects of moraic, or bipositional, mapping when MapGM (Mora) ranks sufficiently high that all moras map to the grid. Example (66b) illustrates this type of

mapping for a heavy syllable. There is, of course, no difference between monopositional and bipositional mapping in light syllables.

The significance of being able to map heavy syllables either monopositionally or bipositionally will become more apparent in Chapters 4 and 5. For now, I will illustrate with a single example. Following a stressed monopositionally-mapped syllable with another stressed syllable creates a clash configuration, but following a stressed bipositionally-mapped syllable with another stressed syllable does not:

(67) Heavy Syllables and Clash

a. Clashing	b. Non-Clashing
x x	x x
x x	x x x
μ μ μ	μ μ μ
√	√
σ σ	σ σ

In (67), the gridmarks on the lower level are those corresponding to moras. The gridmarks on the higher level represent foot-level entries, indicating the presence of secondary stress. In (a), a stressed syllable follows a stressed monopositionally-mapped heavy syllable. Since the foot-level gridmarks have no intervening entry on the mora-level, this is a clash configuration. In (b), a stressed syllable follows a stressed bipositionally mapped heavy syllable. Since the gridmarks on the foot-level do have an intervening entry on the mora-level, this is not a clash configuration. Languages whose heavy syllables are bipositionally mapped, then, will be able to have their stressed heavy syllables followed by other stressed syllables without violating *Clash, but languages whose heavy syllables are monopositionally mapped will not.

Wargamay (Dixon 1981, see also Hayes 1995) is a trochaic language and a likely example of one whose heavy syllables are monopositionally mapped. As (68a) illustrates, heavy syllables are never immediately followed by another stressed syllable even when another foot is possible. Cahuilla (Seiler 1965, 1967, 1977, and Seiler and Hioki 1979; see also Levin 1988 and Hayes 1995) is a likely example of a trochaic language whose heavy

syllables are bipositionally mapped. As (68b) illustrates, heavy syllables can be immediately followed by another stressed syllable.

(68) Monopositional and Bipositional Heavy Syllables

a. Wargamay

\acute{H} L L $g\acute{i}:ba\tau a$ *fig tree*

b. Cahuilla

\acute{H} \grave{L} L $h\acute{a}?\grave{t}i'sqal$ *he is sneezing*

In the Wargamay example, /gi:/ is a stressed heavy syllable, but it is not followed by another stressed syllable even though the two final syllables could form a trochee. In the Cahuilla example, /hɑʔ/ is also a stressed heavy syllable, but it is immediately followed by another stressed syllable. The difference between these languages is in how the moras in the heavy syllables map to the grid. In Wargamay, only the head mora would correspond to a gridmark, meaning that the syllable is monopositionally mapped, as in (67a), and create a clash configuration if followed by another stressed syllable. In Cahuilla, each mora in the syllable would correspond to a gridmark, meaning that the syllable is bipositionally mapped, as in (67b), so that it can be followed by another stressed syllable without creating clash.

2.6.3 Higher Levels

We turn now to the specific MapGridmark constraints responsible for mapping the higher prosodic categories. There are two crucial points about their implementation. First, like MapGM (Mora) above, they are constraints, and they are violable. This means that it is possible to have prosodic categories that do not correspond to gridmarks at all. One such case is that of the trochaic double offbeat pattern of Pintupi discussed in Chapter 1:

(69) Stressless Feet

 x x x
ti li ři ŋulampa tju
 ✓ ✓ ✓ |

As (69) illustrates using the seven-syllable /tíĩrìŋulàmpatju/, the odd-parity forms of trochaic double offbeat patterns leave their final foot stressless in order to satisfy NonFinality.

Second, unlike the Uniqueness of Head to Domain condition that prevents feet and other prosodic categories from sharing heads, there is no condition that prohibits categories from sharing gridmarks. When two different categories of the same level intersect one gridmark can correspond to both. An example is the trochaic minimal alternation pattern of Warao discussed in Chapter 1:

(70) Intersection and Gridmark Sharing

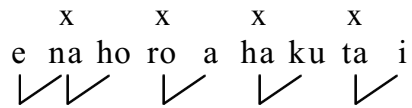

As (70) illustrates using the nine-syllable /enàhoròahàkutái/, the odd-parity forms of trochaic minimal alternation have an intersection at the right edge, and the two intersected feet share a single foot-level gridmark. This gridmark sharing configuration allows Strict Layering and the foot-stress relationship to be maintained without violating *Clash. Note that moras are the exception to this possibility. As moras have no prosodic constituents, they cannot intersect in the appropriate sense and, thus, are unable to share gridmarks.

The constraint specifically governing the relationship of feet to the grid is given in (71).

(71) MapGM (Ft)

A foot-level gridmark is realized within the domain of every foot.

As mentioned earlier, the constraint does not say where in the domain of the foot the gridmark is to be located. As far as MapGM (Ft) is concerned, the gridmark could fall on either the head or the non-head, as illustrated in (72).

(72) Satisfaction of MapGM (Ft)

a. Trochaic Head



b. Iambic Head



c. Trochaic Non-Head



d. Iambic Non-Head



In (a, b) above, the gridmark corresponds to the head of the foot, but in (c, d) the gridmark corresponds to the non-head. The Gridmark to Head condition, however, rules out the (c, d) configurations, except in cases of intersection, as seen below.

(73) Mapping Intersecting Feet

a. Trochees



b. Iambs



In the trochaic example (73a), the foot level gridmark falls within the domain of both feet satisfying MapGM (Ft) for each. Although the gridmark falls on the non-head syllable of the first foot, this syllable is also the head of the second foot. Thus, (73a) also meets the Gridmark to Head condition. In the iambic example (73b), the same situation holds, except that this time the non-head syllable of the second foot is also the head of the first. Again, (73b) meets both MapGM (Ft) and the Gridmark to Head condition. Note also that these configurations exhibit prosodic heads without gridmarks. There is no gridmark corresponding to the head of the first foot in (73a) and no gridmark corresponding to the head of the second foot in (73b).

Mapping the prosodic word to the grid also falls within the domain of the Map-Gridmark family of constraints. The particular constraint for prosodic words is stated in (74).

(74) MapGM (PrWd)

A prosodic word-level gridmark is realized within the domain of every prosodic word.

As is the case with the foot-level version of the constraint, MapGM (PrWd) does not care where in the prosodic word the gridmark is realized. Each of the configurations in (75) satisfies the constraint.

(75) Satisfaction of MapGM (PrWd)

a. Head

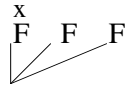

b. Non-Head

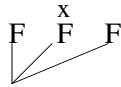

c. Non-Head

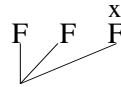

Although each example in (75) would satisfy MapGM (PrWd), only (a) also satisfies the universal Gridmark to Head requirement. This would exclude the (b, c) examples, where gridmarks correspond to non-head feet, except in the case where the non-head foot is also the head foot of another prosodic word. This could happen in intersections, as (76) illustrates.

(76) Mapping Intersecting Prosodic Words

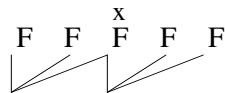

In (76), the gridmark occurs within the domain of both prosodic words, satisfying MapGM (PrWd) for each. Although the gridmark occurs over a non-head foot of the first prosodic word, this foot is also the head of the second prosodic word. The Gridmark to Head condition, then, is also met.

2.6.4 Relativization to Prosodic Heads

In addition to the general constraints of the form MapGM (PCat), I take it that MapGridmark constraints may also exist in a form relativized to the domains of prosodic heads:

(77) MapGM (PCat1, PCat2-Hd)

A gridmark of the appropriate level falls within the domain of every PCat1 (\neq Syll) which occurs within the domain of some (PCat2-Hd).

Like the general MapGridmark constraints, constraints of the form in (77) demand that prosodic categories map to the metrical grid. The (77) formulation is more narrow in application, however, in that this requirement need only be satisfied if the prosodic category occurs within the domain of a prosodic head. The constraint in (78), for example, which demands that all moras occurring within the head of a prosodic word be mapped to mora-level entries on the metrical grid, will be crucial in the proposed analysis of defaults-to-opposite-side systems in Chapter 5.

(78) MapGM (Mora, PrWd-Hd)

A mora-level gridmark occurs within the domain of every mora which itself occurs within the domain of the head of a prosodic word.

This particular constraint allows the grammar to insist on the mapping of non-head moras within the head foot of a prosodic word without necessarily requiring the mapping of all other non-head moras. This possibility will be crucial to the analysis of defaults-to-opposite-side systems in Chapter 5.

2.6.5 Summary

We have seen in the discussion above that the proposed account constructs the base layer of the grid through the mandatory association of gridmarks to head moras and the possibility of associating gridmarks to moras generally through the MapGridmark constraint MapGM (Mora). Syllables are not directly mapped to the grid, but syllabic mapping occurs indirectly, in a sense, when only head moras are mapped. Foot, Prosodic Word, and higher categories are mapped to the grid only by the MapGridmark family of constraints, constraints which exist in both general versions and versions specific to the domains of prosodic heads. As constraints, the MapGridmark family are violable, making it possible to have stressless categories on the surface.

2.7 Some Objections Countered

Although no mainstream linguistic theory that I am aware of has actually utilized improper bracketing, the explicit ban against improper bracketing in prosodic theory has its roots in the proposals of Liberman 1975. In the context of a discussion on the nature of metrical patterns, Liberman notes in passing of Cooper and Meyer's (1960) theory of musical rhythm that "Cooper and Meyer give many examples (of what they call "rhythmic structures") with improper bracketing, that is, where a given element may be shared between adjacent constituents."¹⁰ Liberman gives his reason for not including these types of structures in his theory of linguistic rhythm:

We will assume that such circumstances either do not arise in language, or (more realistically) are always to be analyzed as a structural ambiguity, representing the existence of two equally possible metrical constituent structures for a given example. My reason for choosing this approach is partly that the formal properties of improperly bracketed trees are something of a mystery to me; more importantly, the use of trees of the (linguistically) normal sort represents a more restrictive hypothesis about what metrical patterns are, and thus deserves to be maintained until it can be shown to be wrong.

I hope to have shown in the preceding chapter that maintaining the use of "linguistically normal" trees is wrong, because it does not correctly predict the desired typology. Still, since an extensive use of improper bracketing is something new in this proposal, it is necessary to counter some of the objections, like Liberman's, that have been raised to this type of structure.

2.7.1 Restrictiveness

It is necessary to examine two points in connection with Liberman's reasoning. First, Cooper and Meyer's theory bases musical rhythm on five primitive rhythmic groupings:

¹⁰ Lerdahl and Jackendoff 1983 is another theory of musical rhythm, more closely resembling that of current metrical theory, that also involves overlapping structures.

(79) Cooper and Meyer's Primitive Structures

iamb	˘	—	
anapest	˘	˘	—
trochee	—	˘	
dactyl	—	˘	˘
amphibrach	˘	—	˘

In their theory, rhythm occurs as repetitions of these basic units, sometimes with limited mixture of the types:

(80) Rhythm as Sequences of Primitive Groupings

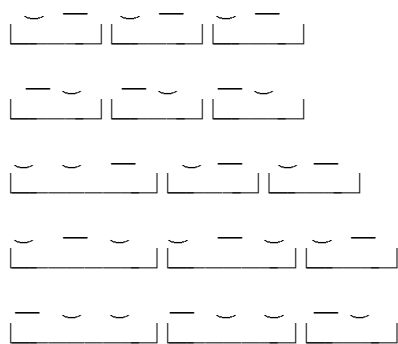

The aspect of the theory that is particularly interesting here, however, is Cooper and Meyer's analysis of patterns that do not fit into one of the five basic groupings, or into sequential combinations of the basic groupings. To deal with patterns like (81a), Cooper and Meyer use combinations of simpler groups, as in (81b).

(81) Use of Improper Bracketing in Cooper and Meyer



The strong-weak-strong pattern of (81a) is analyzed as an intersecting trochee and iamb, as in (81b). The adoption of improperly bracketed structures, then, was an effort to be able to restrict the number of primitive types in their theory so that patterns like (81a) would not have to be among them.

For Cooper and Meyer, restricting the primitive inventory seemed to be their primary concern, and improper bracketing allowed them to have more restrictiveness in this respect than they could have had otherwise. Liberman's single binary strong/weak relation-

ship as a primitive, however, is much more restrictive at the outset than Cooper and Meyer's five types. From Liberman's perspective, allowing intersections would only make his theory less restrictive, as the possible relations and associations between his primitive structures would become more complex. In his theory, positions in the tree are either strong or weak, as in (82a). Introducing the possibility of designating positions as both strong and weak, as in (82b), would have been a serious complication.

(82) Potential Effects of Intersection on Strong/Weak Distinction



The point is that the disagreement boils down to a difference in theoretical perspective. The restrictiveness of allowing improper bracketing depends very much on the context.

In the context of the current proposal, allowing improper bracketing is more restrictive than disallowing it, due to the formulation of the MapGridmark constraints. As discussed above, when two feet intersect, MapGM (Ft) can be satisfied for both feet simultaneously by placing a gridmark on the syllable in the intersection. This allows intersecting patterns to harmonically bound certain other possible patterns, as discussed in Chapter 1 and illustrated for odd-parity iambic forms below:

(83) Restrictiveness of Intersections

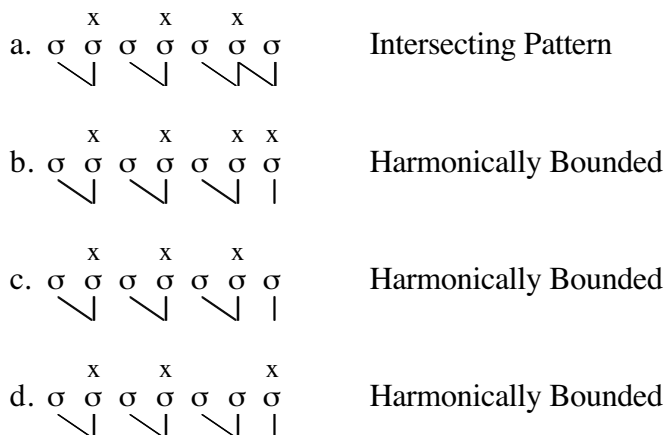

In (83), all the forms would do equally well with respect to foot-head alignment, as the heads are in identical positions in each form. Forms (a) and (b) would also do equally well

with respect to MapGridmark, as each foot in both has a gridmark within its domain. Example (b), however, would violate *Clash where (a) would not. As there is no other difference between them, (a) harmonically bounds (b). Next, (a) and (c, d) would do equally well with respect to clash avoidance. Example (a) would do better, however, with respect to MapGridmark, than either (c, d), as all the feet in (a) have a gridmark within their domain, but a single foot in each of (c, d) does not. As there are no other differences between them, (a) harmonically bounds (c, d).

Now compare the gridmark patterns. The pattern of (83c) is the same as (83a), but the patterns of (83b, d) are different. The pattern of (83a, c) is possible in the parsing of (83a), but the patterns of (83b, d) are not possible. There are fewer possible gridmark patterns using improper bracketing than there are without it. In the context of predicted stress patterns, then, allowing improper bracketing in the theory makes it more restrictive than it would be otherwise.

The second point to consider in connection with Liberman's reasoning is that Liberman's objection is partially about interpretation. Liberman states that "the formal properties of improperly bracketed trees are a 'mystery'", but since Liberman had actually already discussed some of the formal properties— an element is shared between two constituents— I take the "mystery" to be how the rules or constraints of a grammar *interpret* these types of structures. As we shall see, this is very similar to the concern raised in Kenstowicz 1995, although Kenstowicz advances some possible approaches.

2.7.2 Interpretation

To my knowledge, Kenstowicz (1995) is the only researcher to seriously investigate the idea of intersecting prosodic structures, and his examination clearly outlines some of the problems that the idea would have to overcome. He posits two possible representations for intersecting feet:

(84) Intersections in Kenstowicz 1995

a. One Metrical Plane



b. Two Metrical Planes

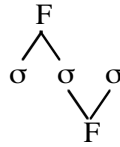

In the (84a) example, the feet are considered to be on the same metrical plane, but in example (84b), the feet are considered to be on two different planes.

Kenstowicz picks up the same point of doubt as Liberman had earlier, rightly indicating that “under either story some decision must be made as to how to interpret such intersecting structures”. With respect to the configuration in (84a), Kenstowicz argues that the syllable in the intersection is both a head and a dependent and it should be subject to rules that refer to either. This, he says, is parallel to “the way in which an affricate should be subject to rules that mention [+continuant] and [-continuant].” With respect to the type of structure in (84b), Kenstowicz states that it might be interpreted as the first foot overshadowing the second.

Since the proposed theory takes (84a) to be the correct structure, I will only deal with Kenstowicz’ objections to this particular possibility. Kenstowicz’ first objection is in the context of a discussion of Carib (Hoff 1968, see also Inkelas 1989), an iambic lengthening language. Carib regularly lengthens every even-numbered, non-final syllable in base forms, as in (85a), but in forms with a monosyllabic prefix, the first two syllables of the base both lengthen, as in (85b).

(85) Carib Forms (from Kenstowicz 1995)

- | | | |
|----|--------------------|-------------------------------|
| a. | kuraama | <i>to look after</i> |
| | poroopi | <i>to stop</i> |
| | kuriiyara | <i>canoe</i> |
| | wotuuropooro | <i>cause to ask</i> |
| b. | ki - kuuraama - ko | <i>you must look after me</i> |
| | ni - pooroopi - i | <i>actually he stopped</i> |

The intersecting analysis that Kenstowicz considers is one where an intersection of the first two feet contains the first syllable of the base in forms like (85b):

(86) Intersection in Carib

ki + kurama + ko → ki + kuu raa ma + ko

Kenstowicz argues that if the purpose of iambic lengthening is to create a durational contrast between a foot’s head and non-head, then iambic lengthening cannot explain the pattern in (86). The first foot participating in the intersection— the foot where [kuu] is the head— is light-heavy, having the expected configuration of contrast between the head and the non-head. The second foot in the intersection— the foot where [kuu] is the non-head— is heavy-heavy, with no more contrast than if the syllables had both remained light. As Kenstowicz notes, lengthening both heads in an intersecting configuration simultaneously “enhances the durational contrast in the first foot” and “neutralizes the durational contrast in the second foot”.

It will be helpful to return here to Kenstowicz’ affricate analogy. There are two considerations to address. The first has to do with what the constraints of the grammar can refer to. It is not clear that the head-dependent relationship is parallel to the [+continuant]-[-continuant] relationship. Although we do expect rules or constraints that can refer to [+continuant] and [-continuant], and we expect rules or constraints that refer to heads, it is not clear that there should be rules or constraints that can refer to dependents. For example,

a syllable that is designated as the head of a foot stands out from other syllables by virtue of its designation, and we can reasonably expect constraints that refer to head syllables apart from other syllables. On the other hand, a non-head syllable may simply be just a plain, ordinary syllable with nothing that should attract attention apart from others.

The second consideration has to do with the degree of complexity in rules or constraints that the theory should tolerate. We do expect affricates to be subject to rules that mention both [+continuant] and [-continuant], but we do not expect to combine these rules into a single complexity. In other words, we do not expect these rules to take a form like “[-continuant] → [-voice] *and* [+continuant] → [+voice]” or “make [+continuant] more voiced than [-continuant]” This situation would obviously lead to great distress on the part of the affricates. The two conjuncts, if rules, could more plausibly be two separate and ordered rules, or they might be two separate and ranked constraints. We would not, however, expect to combine them into a single rule or a single constraint, as the head-dependent contrast formula does with iambic lengthening.

The grammar should really have no trouble interpreting intersecting structures as long as appropriate constraints are posited. For example, if we were to adopt Kager’s (1995) proposal, as we will in Chapter 5, that iambic lengthening is really the effect of a NonFinality constraint within the foot, then iambic lengthening does explain the lengthened syllables of (86):

(87) NonFinality in the Foot

No foot-level gridmark occurs on the final mora of a foot.

If the feet in (86) had to be right-headed but could not have stress on their final mora, the heads of these feet would lengthen, with stress occurring on the first mora of the head syllable and with no stress occurring on the second mora of the head syllable (the final mora of the foot):

(88) Iambic Lengthening with NonFinality (Ft)

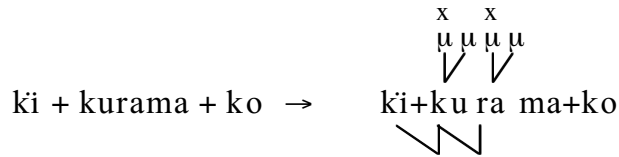

In the intersecting configuration in (88), /ku/ is the head of the first foot, and /ra/ is the head of the second foot. Both syllables lengthen so that stress can occur on the head without having to occur on the final mora. The NonFinality approach to iambic lengthening, then, has no trouble in interpreting the intersecting configuration and is able to obtain the correct results.

Kenstowicz’ second objection arises in the context of boundary-induced stress perturbations in Polish (Rubach and Booij 1985). Kenstowicz argues that the possibility of using intersecting feet to explain boundary-induced dactyls, such as the one in (89), is not viable due to the fact that the heads of feet are always marked by stress.

(89) Boundary-Induced Dactyls in Polish

tèn rewolùcjoniśta *this revolutionary*

In other words, according to Kenstowicz, intersecting feet cannot explain the pattern in the first three syllables of (89), the same pattern illustrated in (90a), because one of the feet would be “headless”, as in (90b). Kenstowicz contends that (90c), where both feet are stressed, is the only possible realization of a trochaic intersecting configuration.

(90) Intersections and Stress

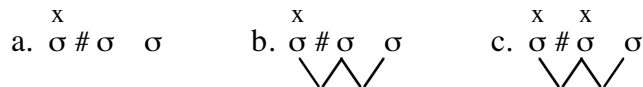

This is a case where the violability of the relationship between feet and gridmarks, as formulated in the MapGridmark constraints, would be crucial to the success of the intersection analysis. Violability makes possible the option in (90b), where the first foot in the intersection corresponds to a gridmark, but the second foot does not. Although this is not a possibility that Kenstowicz considers, it is not an unnatural move to make, especially as deep as

we are into the Era of Violability. There are even several precedents for this move reaching fairly far back in the literature.¹¹

What we have learned from exploring Kenstowicz' objections is that being able to appropriately interpret intersecting configurations depends on the types of constraints that we posit for the grammar. It is important to realize that such a significant change in structural assumptions will necessarily entail the reevaluation of relations, constraints, and conditions that have been posited previously. One could not expect the principles that were appropriate to a theory which banned improper bracketing to translate directly and without modification to a theory which tolerates improper bracketing.

2.8 Summary

In this chapter, we have introduced three distinguishable systems that are central to the proposal: the prosodic hierarchy, prosodic prominence, and the metrical grid. We also saw several constraints and conditions that either facilitate or restrict interaction between these systems. Among the more significant departures from the standard account were the violability of the relationship between stress and feet, the possibility of gridmark sharing, and the toleration of improper bracketing. As the last departure may be the most controversial, I countered several possible objections to this configuration.

¹¹ The first theory I am aware of that made use of stressless feet is Hayes 1987 which incorporated them as primitives into its basic foot inventory. Subsequent proposals involving stressless feet include Hung 1993, 1994 and Crowhurst 1996.

CHAPTER THREE

ALIGNMENT CONSTRAINTS

Alignment constraints typically play a central role in Optimality Theoretic approaches to metrical stress, and the proposed account is no different in this respect. The proposed account does differ, however, both in the ways that it restricts alignment and in the ways that it puts alignment to use. Some of the restrictions on alignment constraints are indirect. For example, Strict Succession eliminates alignment's ability to produce unfooted syllables, and FootCap eliminates alignment's ability to produce ternary and unbounded feet. It will also be necessary to place more direct limitations on alignment constraints, in particular limitations on the range of structures that alignment refers to.

I have already illustrated two new uses for alignment, if only briefly. The first was providing a way to simultaneously affect foot-type and footing directionality. The second was alignment's tendency to promote minimal foot binarity. The structural assumptions of the proposed account necessitate expanding alignment's role even further. For example, alignment will restrict both the occurrence and position of intersecting feet in much the same way that it restricts the occurrence and position of monosyllabic feet. Alignment will also provide a mechanism to force violations of the MapGM (Ft) constraint so that it will be possible to have strings of stressless feet in surface forms or strings of gridmark sharing configurations in surface forms.

In this chapter, we will examine more closely the workings of alignment in the proposed account. In particular, we will explore the properties of individual constraints that refer to prosodic heads, prosodic categories, and gridmark entries. In the course of this discussion, I will propose several restrictions on the possible referents of alignment constraints in order to maintain the degree of restrictiveness sought for the theory in Chapter 1.

3.1 The Locations of Foot-Heads

Alignment relationships between edges of prosodic heads and edges of prosodic categories play a fundamental role in determining the positions of stress. In particular, their role is to

determine the positions of the prosodic heads that gridmark entries will be associated with. Since foot-level gridmarks, when they occur, must correspond to the heads of feet, alignment constraints referring to foot-heads are primarily responsible for determining the possible locations of secondary stress. In Chapter 1, I introduced the two sets of alignment constraints repeated in (1) and (2). Both types refer to the edges of heads of feet— rather than to the edges of feet themselves— and to the edges of prosodic words.

(1) Ft-Head Alignment

Hds-Left or Align (Ft-Hd, L, PrWd, L): the left edge of every foot-head is aligned with the left edge of some prosodic word.

Hds-Right or Align (Ft-Hd, R, PrWd, R): the right edge of every foot-head is aligned with the right edge of some prosodic word.

(2) Prosodic Word Alignment

PrWd-L or Align (PrWd, L, Ft-Hd, L): the left edge of every prosodic word is aligned with the left edge of some foot-head.

PrWd-R or Align (PrWd, R, Ft-Hd, R): the right edge of every prosodic word is aligned with the right edge of some foot-head.

The difference between the two types is in their quantification. Foot-head alignment aligns the appropriate edge of every foot-head with the appropriate edge of some prosodic word. Prosodic word alignment reverses the order of reference and aligns the appropriate edge of every prosodic word with the appropriate edge of some foot-head.

3.1.1 Basic Properties and Restrictions

Due to their quantificational differences, foot-head alignment and prosodic word alignment exert different degrees of influence over foot-heads. Because foot-head alignment constraints refer to *every* foot-head, they have influence over every foot-head within the prosodic word, and every foot-head may potentially produce violations. For example, (3) demonstrates that not only the rightmost foot-head in a form counts for violations of Hds-Right, but every other foot-head in the form counts for violations as well. (In this and the examples

that follow, a dotted vertical line indicates the position of a foot-head without specifying the shape of the foot in which it occurs.)

(3) Foot-Head Alignment and Multiple Foot-Heads

σσσσσσ	Hds-Right
a. σ σ σ σ σ σ ⋮	*
b. σ σ σ σ σ σ ⋮ ⋮	* ***
c. σ σ σ σ σ σ ⋮ ⋮ ⋮	* *** *****

Each of the (3) candidates is a six-syllable prosodic word. In candidate (a), there is a single foot-head, the fifth syllable, and one Hds-Right violation. In candidate (b), the third syllable is also a foot-head, and its three violations are added to the one of the fifth syllable. In candidate (c), the first syllable is additionally designated as a foot-head, and its five violations are added to the four of the third and fifth syllables.

Because prosodic word alignment constraints refer to *some* foot-head, they have influence over only one foot-head within the prosodic word— in particular the closest one to the designated edge of alignment— and only this foot-head may produce violations. For example, (4) demonstrates that only the rightmost foot-head in a form produces violations of PrWd-R.

(4) Prosodic Word Alignment and Multiple Foot-Heads

σσσσσσ	PrWd-Right
a. σ σ σ σ σ σ ⋮	*
b. σ σ σ σ σ σ ⋮ ⋮	*
c. σ σ σ σ σ σ ⋮ ⋮ ⋮	*

In (4), the candidates are the same as those from (3), but this time only the fifth syllable (the rightmost foot-head) produces violations. There is a single violation in each of candidates (a-c).

There are potentially two ways to satisfy a foot-head alignment constraint: vacuously and non-vacuously. Vacuous satisfaction would mean that there are no foot-heads in the form to produce violations. Non-vacuous satisfaction would mean that there is only one foot-head and that this foot-head is exactly aligned with the appropriate edge of the prosodic word. In (5), candidate (a) illustrates vacuous satisfaction of Hds-Right, and candidates (b) and (c) both illustrate non-vacuous satisfaction.

(5) Satisfaction of Hds-Right

σσσ	Hds-Right
a. σ σ σ	
b. σ σ σ 	
c. σ σ σ 	

In (5), each of the candidates are three-syllable prosodic words. None of the (a) candidate's syllables are footed, and, since it has no feet, candidate (a) has no foot-heads to incur alignment violations. Candidate (b) has a single iamb containing the second and third syllables. Since there is only one foot, and the head of this foot is exactly aligned with the right edge of the prosodic word, there are no violations. The (c) candidate's syllables are all contained in a single unbounded foot. The head of this foot is exactly aligned with the right edge of the prosodic word, and there are no violations.

The proposed account's adoption of Strict Succession rules out the option of vacuous satisfaction. Since all syllables must be footed, there must always be at least one foot-head in every output candidate. Strict Succession also rules out the type of non-vacuous satisfaction illustrated in (5b). All candidates must have a sufficient number of feet (and

foot-heads) to parse their syllables. If the foot is disyllabic as in (5b), one foot will not be sufficient to parse more than two syllables. The FootCap Condition rules out the option of expanding a single foot to larger-than-disyllabic size, as in (5c). All candidates with more than two syllables must have more than one foot. Since feet can be no larger than disyllabic, even-parity candidates must always have a number foot-heads at least equal to the number of non-heads, and odd-parity candidates must always have a number of foot-heads at least greater by one than the number of non-heads. This means that all candidates with more than two syllables will have multiple foot-heads and at least one foot-head alignment violation. It also means that the number of foot-head alignment violations that candidates incur will necessarily increase as the candidates become larger.

As the size of candidates and the number of foot-heads increase, the number of violations multiplies. Larger candidates necessarily mean more foot-heads at significant distances from the designated edge of alignment. The further a foot-head occurs away from the designated edge, the more foot-head alignment violations it will incur:

(6) Violations of Hds-Left and Hds-Right

$\sigma\sigma\sigma$	Hds-Left	Hds-Right
a. $\begin{array}{ccc} \sigma & \sigma & \sigma \\ & \vdots & \end{array}$		* *
b. $\begin{array}{ccc} \sigma & \sigma & \sigma \\ & \vdots & \end{array}$	*	*
c. $\begin{array}{ccc} \sigma & \sigma & \sigma \\ & & \vdots \end{array}$	* *	

In (6), each of the candidates are three-syllable prosodic words. In candidate (a), the first syllable is designated as a foot-head; in (b), the second syllable; and in (c), the third syllable. The number of Hds-Left violations increases from (a) to (c) as the foot-head moves away from the left edge of the prosodic word and towards the right edge, while the number of Hds-Right violations increases from (c) to (a) as the foot-head moves away from the right

edge of the prosodic word and towards the left edge. With multiple foot-heads, violations at short, medium, and long distances will be added on top of each other as in (3) above.

Vacuous and non-vacuous satisfaction are also potential options for prosodic word alignment. Vacuous satisfaction would mean that there is no prosodic word to incur violations. Non-vacuous satisfaction would mean that there is a prosodic word and that it is exactly aligned with the appropriate edge of some foot-head. In the tableau in (7), candidate (a) illustrates vacuous satisfaction of PrWd-R, and candidate (b) illustrates non-vacuous satisfaction.

(7) Satisfaction of PrWd-R

	$\sigma\sigma\sigma$	PrWd-R
a.	$\begin{array}{ccc} \sigma & \sigma & \sigma \\ & \vdots & \end{array}$	
b.	$[\ \sigma \ \sigma \ \sigma \]_{\text{PrWd}}$ $\begin{array}{ccc} & & \vdots \\ & & \end{array}$	

Both of the candidates in (7) consist of a string of three syllables. Because there is no prosodic word in the (a) candidate to incur violations and because the constraint does not require the existence of a prosodic word, (a) satisfies PrWd-R even though the rightmost foot-head is one syllable removed from the right edge of the form. In candidate (b), there is a prosodic word that has the potential to incur violations, but the rightmost foot-head occurs at its right edge, and PrWd-R is satisfied.

As with prosodic word alignment above, the adoption of Strict Succession rules out vacuous satisfaction for prosodic word alignment constraints. Since all syllables must be footed and all feet must be included in prosodic words, every output candidate will have at least one prosodic word. The existence of multiple foot-heads in longer forms, however, due to the FootCap condition, does not have the effect on prosodic word alignment that it has on foot-head alignment. Since only the foot-head closest to the designated edge has the potential to produce prosodic word alignment violations, increasing candidate size, and thus the

number of feet and foot-heads required to parse the form, does not necessarily lead to an increase in violations.

In fact, the adoption of the Lapse Condition limits the possible number of prosodic word alignment violations that any candidate can incur to one. Since for every two adjacent syllables one must be a foot-head, the leftmost foot-head in a form cannot be more than one syllable removed from the left edge, and the rightmost foot-head cannot be more than one syllable removed from the right edge. A form like that in (8), then, which would incur two violations of PrWd-R, cannot be considered as an output candidate.

(8) Prohibited Candidate

$$\begin{array}{ccccccc} \sigma & \sigma & \sigma & \sigma & \sigma & \sigma & \sigma \\ \vdots & & \vdots & & \vdots & & \end{array}$$

In (8), the rightmost foot-head is two syllables removed from the right edge of the prosodic word, meaning that neither of the final two syllables are foot-heads and that the form does not comply with the Lapse Condition. A similar effect arises from the combination of Strict Succession and FootCap. Since every syllable must be included in a foot, and feet may be no larger than disyllabic, it is not possible for either edge of a form to be more than one syllable removed from a foot-head.

3.1.2 Foot-Head Alignment

Foot-head alignment constraints were introduced to the theory, along with Strict Succession, to make a default connection between footing directionality and foot-type such that the head's position within the foot would match footing directionality. This effect is accomplished indirectly. The foot-head alignment constraints in (1) are direct relationships between the edges of foot-heads and the edges of prosodic words, the distance between them determining the number of violations that a form will incur. Several factors, however, are involved in locating a foot-head in relation to prosodic word edges. Among these are the size of the prosodic word itself, the position of the foot-head within its foot, and the position of the foot within the prosodic word. When ranked highly enough, a foot-head alignment

constraint exerts an indirect influence over each of these factors. Since I have already discussed the relationship between a candidate's size and the number of violations that it might incur, I will focus here on the factors of foot-type and footing directionality.

In general, when a foot-head alignment constraint ranks sufficiently high as to determine the position of foot-heads within a prosodic word (within the limits set by the non-violable conditions discussed above), the same constraint will also determine both foot-type and footing directionality. When foot-head alignment is not the only constraint determining the position of foot-heads, it loses the ability to exert control over the two factors. Although I will examine both cases in greater detail below, it will be helpful to give an initial description of the relevant situations.

When a candidate's foot-type gives it an advantage in positioning its foot-heads relative to the appropriate edge of a prosodic word, foot-head alignment constraints will prefer this candidate. For example, when the crucial comparison is between two forms with identical foot placement, the head's position within the foot is isolated as the distinguishing factor for the candidates' relative success with respect to foot-head alignment:

(9) Position of the Head within the Foot

$\sigma\sigma\sigma\sigma$	Hds-Left	Hds-Right
a. $\sigma \ \sigma \ \sigma \ \sigma$ <div style="margin-left: 100px;"> \swarrow \searrow </div>	*	**
b. $\sigma \ \sigma \ \sigma \ \sigma$ <div style="margin-left: 100px;"> \swarrow \searrow </div>	**	*

The tableau in (9) compares two four-syllable prosodic words with respect to Hds-Left and Hds-Right. In both examples, the foot occupies the same position within the prosodic word, but the foot in (a) is a trochee where the foot in (b) is an iamb. Because the left edge of the foot-head in (a) is only one syllable removed from the left edge of the prosodic word, but the left edge of the foot-head in (b) is two syllables removed, the trochaic foot in (a) performs better with respect to Hds-Left than the iambic foot in (b). However, because the right

edge of the foot-head in (b) is only one syllable removed from the right edge of prosodic word, but the right edge of the foot-head in (a) is two syllables removed, the iambic foot in (b) performs better with respect to Hds-Right than the trochaic foot in (a). All else being equal, then, leftward foot-head alignment prefers trochaic feet, and rightward foot-head alignment prefers iambic feet.

When a candidate locates its feet in such a way that it has an advantage in positioning its foot-heads relative to the appropriate edge of the prosodic word, foot-head alignment constraints will prefer this candidate. For example, when the crucial comparison is between two forms with identical types of feet, the foot's position within the prosodic word is isolated as the distinguishing factor for the candidates' relative success with respect to foot-head alignment:

(10) Position of the Foot within the Prosodic Word



$\sigma\sigma\sigma\sigma$	Hds-Left	Hds-Right
a. $\sigma \ \sigma \ \sigma \ \sigma$ <div style="margin-left: 100px;"> \swarrow $\sigma \ \sigma$ </div>	*	**
b. $\sigma \ \sigma \ \sigma \ \sigma$ <div style="margin-left: 100px;"> \swarrow $\sigma \ \sigma$ </div>	**	*

The tableau in (10) again compares two four-syllable prosodic words with respect to Hds-Left and Hds-Right. Both forms contain a single trochee, but the trochee in (a) consists of the second and third syllables where the trochee in (b) consists of the third and fourth. Because the foot-head in (a) is only one syllable removed from the left edge of the prosodic word, where the foot-head in (b) is two syllables removed, the foot-head in (a) performs better than the foot-head in (b) with respect to Hds-Left. However, because the foot-head in (b) is only one syllable removed from the right edge of the prosodic word, where the foot-head in (a) is two syllables removed, the foot-head in (b) performs better than the foot-head in (a) with respect to Hds-Right. All else being equal, then, leftward foot-head alignment

prefers leftward footing directionality, and rightward foot-head alignment prefers rightward footing directionality.

There are situations where the differences between candidates with respect to foot-type and footing directionality do not create an advantage in a foot-head's location relative to the edges of the prosodic word. Consider, for example, the offset iamb and trochee in the candidates below:

(11) A Neutral Comparison

$\sigma\sigma\sigma\sigma$	Hds-Left	Hds-Right
a. $\sigma \ \sigma \ \sigma \ \sigma$ 	**	*
b. $\sigma \ \sigma \ \sigma \ \sigma$ 	**	*

The tableau in (11) compares two four-syllable prosodic words with respect to Hds-Left and Hds-Right. Candidate (a) contains a single iamb consisting of the second and third syllables, and candidate (b) contains a single trochee consisting of the third and fourth syllables. Because the foot-head in both candidates (a) and (b) is two syllables removed from the left edge of the prosodic word, the foot-heads perform equally well with respect to Hds-Left. Also, because the foot-head in both candidates (a) and (b) is one syllable removed from the right edge of the prosodic word, the foot-heads perform equally well with respect to Hds-Right. Certain configurations, then, do not allow foot-head alignment to discriminate between candidates as a result of either foot-type or footing directionality.

3.1.2.1 Minimal Alternation: Nengone and Araucanian

The default connection established by foot-head alignment between foot-type and footing directionality is most clearly visible in minimal alternation patterns, where left-headed feet exhibit leftward footing in the trochaic type and right-headed feet exhibit rightward footing in the iambic type:

(12) Minimal Alternation

a. Trochaic

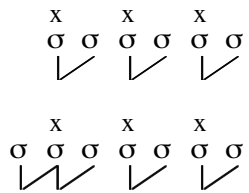

b. Iambic

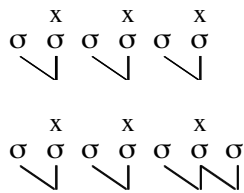

The pattern is symmetrically attested, being found in both its trochaic and iambic versions.

The trochaic minimal alternation pattern is exhibited in languages like Cavinena (Key 1968), Lenakel¹ (Lynch 1974, 1977, 1978; see also Hammond 1986 and Hayes 1995), Nengone (Tryon 1967), Warao (Osborn 1966), Wargamay, and Yakan (Behrens 1975). Example forms from Nengone are given in (13).

(13) Nengone Forms (from Tryon 1967)

σ́σ	móma	<i>old man</i>
σ́σσ	newáta	<i>toe nail</i>
σ́σ́σ	àčakáze	<i>sorcerer</i>
σ́σ́σ́σ	wačaruwíwi	<i>eel</i>

In Nengone, as in each of the other languages mentioned above, every even-numbered syllable counting from the end of a form is stressed. In most of these languages, the stress occurring on the penult is the primary stress. The single exception is Wargamay, where the first stress in a form (found either on the first or second syllable) is the primary stress.

The iambic minimal alternation pattern is exhibited in Araucanian (Echeverria and Contreras 1965):

(14) Araucanian Forms (from Echeverria and Contreras 1965)

σ́σ	ñuké	<i>mother</i>
σ́σσ	akúle	<i>if he comes</i>
σ́σ́σ	elúmuyù	<i>give us</i>
σ́σ́σ́σ	elúaènew	<i>he will give me</i>

¹ Only Lenakel nouns display the trochaic minimal alternation pattern. Verbs and adjectives exhibit the trochaic internal ternary pattern.

As (14) illustrates, stress in Araucanian occurs on every even-numbered syllable counting from the beginning of the form. The stress on the peninitial syllable is the primary stress.

The role of foot-head alignment in obtaining these patterns is significant in several respects, and examining foot-head alignment in this connection is perhaps the simplest way to illustrate the impact that it has in the proposed account. In more fully exploring minimal alternation, we must address several issues. The first is the absence of monosyllabic feet in both even- and odd-parity forms. The second is the presence of an intersecting configuration in odd-parity forms and the lack of such a configuration in even-parity forms. Third is the position in which intersecting configurations occur in odd-parity forms, and fourth is the position of foot-heads within the feet themselves. Although other factors are often involved, the properties of foot-head alignment are central in each of these considerations.

3.1.2.2 Even-Parity Forms

The absence of monosyllables and intersections in even-parity forms is not unique to the minimal alternation pattern. These structures are also absent in the even-parity forms of every other pattern of the typology discussed in Chapter 1. Even-parity forms are always parsed into non-intersecting binary feet, with the only variation between them being limited to the type of foot, iambic or trochaic, used in parsing:

(15) Even-Parity Forms

a. Trochaic

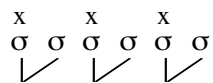

b. Iambic

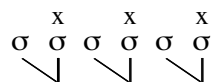

The lack of greater variation is due to the lack of an odd syllable. Since odd syllables do not occur in even-parity forms neither do the types of structure— unparsed syllables, ternary feet, monosyllabic feet, and intersected feet— that might be used to account for them. Since these are the same structures whose positions indicate footing directionality, even-parity forms do not exhibit directionality effects.

Several factors allow the proposed account to predict exactly this situation. Strict Succession, for example, bans the use of unfooted syllables, and FootCap bans the use of ternary feet. This is true in all forms and not just those that are even-parity. Restrictions on monosyllables and intersections, however, fall within the domain of alignment constraints. In Chapter 2, we saw how alignment's preference for a minimal amount of structure promotes disyllabic over monosyllabic feet, but I have not yet discussed why non-intersected feet are typically more desirable than intersected feet. Although the proposal freely allows improper bracketing— in the sense that there is no specific condition or constraint against it— the same property of alignment that restricts the occurrence of monosyllables also restricts the occurrence of intersections.

Alignment's restriction of monosyllables is straightforward. Since each binary foot contains two syllables but each monosyllabic foot contains only one, using monosyllables to parse a form where binary feet are possible only means involving a greater number of feet. More feet mean more foot-heads, and more foot-heads mean more foot-head alignment violations. Due to this situation, alignment will demand that binary feet be utilized wherever possible and that monosyllabic feet be utilized only when necessary.

Since even-parity forms can be exhaustively parsed into binary feet, alignment prefers that monosyllables be absent in this type. In general, it takes at least one more foot to parse an even-parity form when monosyllables are involved than when they are not. For example, (16) demonstrates that parsing a six-syllable form requires only three feet when they are binary, but when monosyllables are involved, at least four are required. Hds-Right demonstrates the effects of alignment:

(16) Monosyllabic vs. Disyllabic

	$\sigma\sigma\sigma\sigma\sigma$	Hds-Right
a.	σ σ σ σ σ σ 	** ****
b.	σ σ σ σ σ σ 	* ** *****!

In (16), the (a) candidate uses only binary feet, but the (b) candidate replaces one binary foot with two monosyllables. Both forms' rightward alignment is the best possible for the types of feet they contain, but because (a) uses larger feet, it is able to have fewer feet and fewer foot-heads than (b). Since fewer foot-heads means fewer foot-head alignment violations, (a) is the winner.

Alignment's restriction of intersection is similar. Since every two non-intersected feet contain four syllables but every two intersected feet contain only three, using intersected feet to parse a form where non-intersected feet are possible only means involving a greater number of feet. Because more feet mean more foot-heads and more foot-head alignment violations, alignment will demand that non-intersected feet be utilized wherever possible and that intersections occur only when necessary.

Since even-parity forms can be exhaustively parsed into non-intersected feet, alignment prefers that intersections be absent. In general, it takes at least one more foot to parse an even-parity form when intersections are involved than when they are not. For example, (17) demonstrates that parsing a six-syllable form requires only three feet when they are not intersected, but when intersections are involved, at least four are required. Hds-Right demonstrates the effects of alignment:

(17) Non-Intersected vs. Intersected

	σσσσσσ	Hds-Right
a.		** ****
b.		* *** **!*

In (17), the (a) candidate uses non-intersected feet, and the (b) candidate uses intersected feet. Both candidates have the best possible rightward foot-head alignment for the types of structure they contain. Because its feet never include a syllable already included in another foot, however, the footing of candidate (a) is more efficient, and it is able to have one fewer foot than candidate (b). Since fewer feet mean fewer foot heads and fewer foot-head alignment violations, candidate (a) is the winner.

In the absence of other considerations, then, the preference of alignment for a minimal amount of structure ensures that both monosyllabic and intersected feet are absent from even-parity forms. Since other aspects of the proposal ban other footing options (ternary feet and non-parsing), even-parity forms will be parsed by non-intersected disyllabic feet, and footing directionality effects will be absent.

The only thing left for even-parity forms is to determine the type of foot used in parsing, the single aspect in which they actually vary. For the trochaic pattern of Nengone, Hds-Left positions foot-heads at the left edge within the foot. This is illustrated using the four-syllable form /àčakáze/ in (18).

(18) Hds-Left

ačakaze	Hds-Left
a. ^x a ^x ča ka ze / /	**
b. a ^x ča ka ^x ze \ \	* **!*

In (18), the four-syllable prosodic word has two non-intersected binary feet in both candidates, due to the considerations discussed above. In candidate (a), the feet are left-headed, but in candidate (b), the feet are right-headed. The trochaic candidate (a) is able to perform better than the iambic candidate (b) on Hds-Left because having its foot-heads as far to the left as possible within the feet also allows them to be as far to the left as possible within the prosodic word. Candidate (a) correctly emerges as the winner.

For the iambic pattern of Araucanian, Hds-Right positions foot-heads at the right edge within the foot. This is illustrated using the four-syllable form /elúmuyù/ in (19).

(19) Hds-Right

elumuyu	Hds-Right
a. e ^x lu mu ^x yu \ /	**
b. ^x e lu mu ^x yu / /	* **!*

In (19), the four-syllable prosodic word has two non-intersected binary feet in both candidates, in accordance with the considerations discussed above. The feet of candidate (a) are right-headed, and the feet of candidate (b) are left-headed. Since having its foot-heads as far to the right as possible within the feet also allows them to be as far to the right as possible

within the prosodic word, candidate (a) performs better on Hds-Right than candidate (b), and (a) correctly emerges as the winner.

3.1.2.3 Odd-Parity Forms

The presence of the odd syllable in odd-parity forms makes their analysis more complex. Each of the alignment effects involved in analyzing even-parity forms— promoting minimality, restricting intersection, and determining foot-type— are involved in analyzing odd-parity forms as well. Two additional considerations, however, are also involved. The first is the determination of footing directionality, a determination where foot-head alignment plays the primary role. The second is the selection of intersected over monosyllabic feet as the means to parse the odd syllable, a selection that foot-head alignment does not influence.

Since the proposed account bans the options of non-parsing and larger-than-binary feet, the only possibilities for footing odd syllables are monosyllabic feet and intersected feet. Although the presence of the odd syllable requires the use of such structures in parsing odd-parity forms, the effects of alignment limits their number to the single one necessary. Once the necessary intersection or monosyllable is introduced, the remaining syllables are even-parity and can be exhaustively parsed using non-intersected binary feet. Using monosyllables or intersections to foot the remaining syllables would only mean using a greater number of feet, and their translation into additional alignment violations would be much the same as for the even-parity cases examined in (16) and (17) above:

(20) Remaining Syllables

a. Intersection

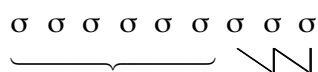

Even-Parity

b. Monosyllable

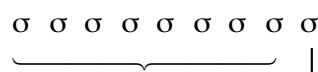

Even-Parity



In (20a), the intersection necessary to foot the odd syllable has been introduced to a nine-syllable form, and there are six syllables remaining. Parsing these remaining syllables with non-intersected feet would involve only three feet, but if intersections were utilized, then four

feet would be needed. Since the additional foot would lead to additional foot-head alignment violations, alignment will demand that intersections not necessary for footing the odd syllable be absent from the form. A similar situation occurs in (20b) where a monosyllabic foot has been used to parse the odd syllable, and there are eight syllables remaining. Parsing the remaining syllables with binary feet would involve only four feet, but if monosyllables were utilized, at least five feet would be needed. As the additional foot would lead to additional violations, foot-head alignment will demand that monosyllables not necessary for footing the odd syllable be absent.

Alignment's preference, then, for a minimal amount of structure limits the intersections or monosyllables in an odd-parity form to the single one necessary for footing the odd syllable. Alignment's influence over footing directionality results from its influence over the positions in which these single monosyllables or intersections occur. An intersection or monosyllable at the right edge of a form results from rightward alignment, but an intersection or monosyllable at the left edge of a form results from leftward alignment.

The property of alignment determining the positions of such structures is closely related to the one just discussed. Not only does alignment prefer minimal structure in general, it also prefers minimal structure away from the designated edge. Structure that is further from the designated edge produces more violations, so alignment prefers the structural concentrations that occur with monosyllabic and intersected feet to be as near the designated edge as possible. As these configurations move away from the designated edge, the number of violations increases. This is demonstrated for monosyllabic feet in (21) and for intersected feet in (22) using Hds-Right:

(21) Effects of Alignment on Position of Monosyllables

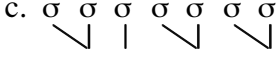
$\sigma\sigma\sigma\sigma\sigma\sigma$	Hds-Right
a. $\sigma \sigma \sigma \sigma \sigma \sigma \sigma$ 	* *** ***** (9)
b. $\sigma \sigma \sigma \sigma \sigma \sigma \sigma$ 	** *** ***** (10)
c. $\sigma \sigma \sigma \sigma \sigma \sigma \sigma$ 	** ***** ***** (11)

In (21a), the monosyllabic foot occurs at the prosodic word's right edge, preceded by a string of binary feet. With the monosyllable in this position, there are nine alignment violations for the seven-syllable form. As the monosyllable moves further away from the right edge in (21b) and (21c), the number of violations increases to ten and eleven respectively.

(22) Effects of Alignment on Position of Intersections

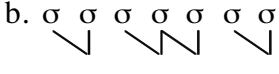
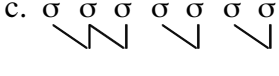
$\sigma\sigma\sigma\sigma\sigma\sigma$	Hds-Right
a. $\sigma \sigma \sigma \sigma \sigma \sigma \sigma$ 	* *** ***** (9)
b. $\sigma \sigma \sigma \sigma \sigma \sigma \sigma$ 	** *** ***** (10)
c. $\sigma \sigma \sigma \sigma \sigma \sigma \sigma$ 	** ***** ***** (11)

In (22a), the intersected feet occur at the prosodic word's right edge, and there are nine alignment violations for the seven-syllable form. As the intersected configuration moves away from the right edge in (22b) and (22c) the number of violations increases to ten and eleven respectively. Since the effects of leftward foot-head alignment in positioning monosyllables and intersections at a prosodic word's left edge are similar, I will omit the additional tableaux.

By determining the positions of odd syllable structures, foot-head alignment produces the directionality effects of odd-parity forms. Still to be addressed, however, is the connection between footing directionality and foot-type. As discussed above, Hds-Right

prefers both rightward footing and right-headed feet, and Hds-Left prefers both leftward footing and left-headed feet. In other words, Hds-Right prefers iambic feet with either a monosyllabic foot or an intersection at the right edge of the form, and Hds-Left prefers trochaic feet with either a monosyllabic foot or an intersection at the left edge. If either one of these considerations— foot-type or footing directionality— are altered, the result will be additional alignment violations.

To demonstrate, first contrast with respect to Hds-Right forms where directionality is rightward and feet are iambic to those where directionality is rightward and feet are trochaic:

(23) Hds-Right

	σσσσσσ	Hds-Right
☞ a.	σ σ σ σ σ σ σ 	* *** ***** (9)
☞ b.	σ σ σ σ σ σ σ 	* *** ***** (9)
c.	σ σ σ σ σ σ σ 	* ** ***** ***** (13)
d.	σ σ σ σ σ σ σ 	** ***** ***** (12)

In (23), the (a) and (b) candidates both exhibit rightward footing with iambs. The difference between them, which has no consequence for foot-head alignment, is that (a) has an intersection at the right edge where (b) has a monosyllable. The (c) and (d) candidates both exhibit rightward footing with trochees, the difference again being that (c) has an intersection where (d) has a monosyllable. Although the positions of the feet in (c) are identical to those in (a) and the positions of the feet in (d) are identical to those in (b), the positions of the foot-heads within the feet of (a) and (b) allow these candidates to perform better with respect to Hds-Right.

Now contrast with respect to Hds-Right forms where feet are iambic and directionality is rightward to those where feet are iambic and directionality is leftward:

(24) Hds-Right

	σσσσσσ	Hds-Right
☞ a.	σ σ σ σ σ σ σ 	* *** ***** (9)
☞ b.	σ σ σ σ σ σ σ 	* *** ***** (9)
c.	σ σ σ σ σ σ σ 	** ***** ***** (11)
d.	σ σ σ σ σ σ σ 	** ***** ***** (12)

In (24), the (a) and (b) candidates are the same as those in (23) above, both exhibiting iambs with rightward footing. The (c) and (d) candidates both exhibit iambs with leftward footing, the difference between them being that (c) has an intersection at the left edge of the form where (d) has a monosyllable. Although every foot in each of the candidates is right-headed, the positions of the feet in (a) and (b) allow these candidates to perform better than (c) and (d) with respect to Hds-Right. As the arguments are similar for the effects of Hds-Left in producing leftward footing with trochees, I will omit the additional tableaux.

Notice also in the (a) and (b) candidates of (23, 24) that the foot-heads' positions in these forms are identical, so that foot-head alignment cannot be used to distinguish between them. In general, foot-head alignment does not distinguish between the use of intersections and the use of monosyllabic feet. There will typically be a form using a monosyllabic foot that performs as well as one using intersecting feet and a form using intersecting feet that performs as well as one using a monosyllable.

Obtaining intersections in particular for odd-parity minimal alternation forms falls not within the domain of alignment, but rather within the domains of the foot-stress relationship and clash avoidance. Although foot-head alignment determines the potential positions

for stress by determining the positions of foot-heads, both the foot-stress relationship and clash avoidance are involved in deciding which of these potential positions will actually occur with stress. An intersecting configuration where a foot-level gridmark is shared between two feet simultaneously satisfies MapGM (Ft) and *Clash where the corresponding footing with a monosyllable would force one of the two to be violated.

As with the even-parity forms, Hds-Left establishes the positions of foot-heads in the odd-parity forms of Nengone and other trochaic minimal alternation languages. Unlike the even-parity forms, however, Hds-Left produces a potential clash configuration in odd-parity forms, so that the possible interactions of MapGM (Ft) and *Clash become a factor. As (25) demonstrates for the five-syllable /wačàruwíwi/, the optimal candidate is one where an intersection, rather than a monosyllable, occurs at the prosodic word's left edge in a gridmark sharing configuration. Notice that this is true regardless of the order in which the relevant constraints are ranked.

(25) Hds-Left, MapGM (Ft), *Clash

wačaruwiwi	Hds-Left	MapGM (Ft)	*Clash
$\text{a. wa}^{\text{x}} \text{ča}^{\text{x}} \text{ru} \text{wi} \text{wi}$ 	* ***		
$\text{b. wa}^{\text{x}} \text{ča}^{\text{x}} \text{ru}^{\text{x}} \text{wi} \text{wi}$ 	* ***		*!
$\text{c. wa}^{\text{x}} \text{ča}^{\text{x}} \text{ru} \text{wi}^{\text{x}} \text{wi}$ 	* ***	*!	
$\text{d. wa}^{\text{x}} \text{ča}^{\text{x}} \text{ru} \text{wi}^{\text{x}} \text{wi}$ 	* ***	*!	
$\text{e. wa}^{\text{x}} \text{ča}^{\text{x}} \text{ru} \text{wi}^{\text{x}} \text{wi}$ 	** ***!*		

In (25), candidate (a) has an intersection at the left edge of the form where candidates (b-d) have a monosyllabic foot. Candidate (e) has a monosyllabic foot at its right edge and is screened out by Hds-Left. Although the position of its monosyllabic foot allows candidate (e) to avoid violations of either *Clash or MapGM (Ft), it also causes (e) to have more violations of Hds-Left than (a-d), which each exhibit the best possible leftward foot-head alignment given the length of the form. MapGM (Ft) screens out candidates (c) and (d). The single stressless foot in each of these candidates allows them to avoid clash, but the same feet also cause (c) and (d) to violate the MapGM (Ft) where (a) and (b) do not. *Clash screens out candidate (b). The two initial foot-level gridmarks of the form would not have an intervening entry one level down, causing candidate (b) to violate the constraint where (a) does not. Candidate (a) correctly emerges as the winner.

Hds-Right determines the positions of foot-heads in the odd-parity forms of Araucanian, just like those in its even-parity forms. In odd-parity forms, however, Hds-Right produces a potential clash configuration at the right edge, so that the possible interactions of MapGM (Ft) and *Clash become a factor. As (26) demonstrates for the five-syllable /elúa`new/, the optimal candidate is one where an intersection occurs at the right edge of the form in a gridmark sharing configuration. This is true regardless of the order in which the relevant constraints are ranked.

(26) Hds-Right, MapGM (Ft), *Clash

eluaenew	Hds-Right	MapGM (Ft)	*Clash
a. $\begin{array}{cccc} & x & & x \\ e & lu & a & e\ new \\ & \swarrow & \swarrow & \swarrow \end{array}$	* ***		
b. $\begin{array}{cccc} & x & & x & x \\ e & lu & a & e\ new \\ & \swarrow & \swarrow & & \end{array}$	* ***		*!
c. $\begin{array}{cccc} & x & & x \\ e & lu & a & e\ new \\ & \swarrow & \swarrow & \end{array}$	* ***	*!	
d. $\begin{array}{cccc} & x & & x \\ e & lu & a & e\ new \\ & \swarrow & \swarrow & \end{array}$	* ***	*!	
e. $\begin{array}{ccc} x & x & x \\ & \swarrow & \swarrow \\ e & lu & a\ e\ new \end{array}$	** ***!*		

In (26), candidate (a) has an intersection at the right edge of the prosodic word where candidates (b-d) have a monosyllabic foot. Candidate (e) has a monosyllabic foot at its left edge and is screened out by Hds-Right. The position of its monosyllabic foot allows candidate (e) to avoid violations of either *Clash or MapGM (Ft), but it also causes (e) to have more Hds-Right violations than (a-d). MapGM (Ft) screens out candidates (c) and (d). The stressless foot in each of these candidates allows them to avoid clash, but they also cause (c) and (d) to violate MapGridmark where (a) and (b) do not. *Clash screens out candidate (b). The final two foot-level gridmarks of the form would not have an intervening entry one level down, causing candidate (b) to violate the constraint where (a) does not. Candidate (a) correctly emerges as the winner.

To summarize, we have seen how foot-head alignment promotes minimality, restricts intersection, and influences both footing directionality and foot-type. The occurrence of monosyllabic and intersected feet are restricted by alignment's preference for a minimal

amount of structure. Footing directionality is a function of foot-head alignment's ability to position feet within the prosodic word, in particular those types of feet used to parse odd syllables, and foot-type is a function of alignment's ability to position the heads of feet within the feet themselves. Each of these considerations were crucial in obtaining the basic stress patterns of minimal alternation languages.

3.1.3 Prosodic Word Alignment

Prosodic word alignment was introduced in Chapter 1 as a means to disrupt the default connection between foot-type and footing directionality established by the foot-head alignment constraints. Although its direct influence over the position of foot-heads in a form may seem minimal compared to that of foot-head alignment, the crucial aspect of prosodic word alignment is that it has any influence at all. Prosodic word alignment's ability to fix the position of a foot-head independently of foot-head alignment means that the demands of the two are potentially in conflict over any head that is affected by both. Since foot-head alignment directly affects all foot-heads within the prosodic word, but prosodic word alignment directly affects only one, any conflict will most immediately concern the foot-head in best position to satisfy the prosodic word alignment constraint. As we shall see below, however, the Lapse Condition actually extends the potential for conflict to the remaining foot-heads as well.

The potential for conflict will only be realized when satisfying the demands of one type of constraint would lead to a violation of the other, but it is not the case that prosodic word alignment always makes demands contrary to those of foot-head alignment. The demands of the two types will not be in conflict when the directional specifications of the relevant constraints happen to match. For example, a foot-head at the left edge of a prosodic word, the configuration necessary for satisfying PrWd-L, would not incur violations of Hds-Left, and a foot-head at the right edge of a prosodic word, the configuration necessary for satisfying PrWd-R, would not incur violations of Hds-Right. The demands of the two

types will only conflict when the directional specifications of the relevant constraints do not match. For example, in all forms with more than one syllable, a foot-head at the left edge of the prosodic word, the configuration demanded by PrWd-L, would incur fewer Hds-Right violations if it occurred further to the right, and a foot-head at the right edge of a prosodic word, the configuration demanded by PrWd-R, would incur fewer Hds-Left violations if it occurred further to the left.

To demonstrate this conflict more clearly, consider the tableau below, which compares two two-syllable prosodic words with respect to PrWd-L and Hds-Right:

(27) Conflicting Demands

$\sigma\sigma$	PrWd-L	Hds-Right
a. $\begin{array}{c} \sigma \quad \sigma \\ \quad \swarrow \end{array}$		*
b. $\begin{array}{c} \sigma \quad \sigma \\ \quad \searrow \end{array}$	*	

In (27), the (a) candidate has a foot-head at its left edge, and the (b) candidate has a foot-head at its right edge. The position of the foot-head in (a) allows it to satisfy PrWd-L but forces it to violate Hds-Right. The position of the foot-head in (b) allows it to better satisfy Hds-Right but forces it to violate PrWd-L. Since the two constraints are in conflict over the position of the single foot-head, one's satisfaction must come at the other's expense. If PrWd-L is the higher ranked constraint, then the foot-head will occur at the prosodic word's left edge, but if Hds-Right is the higher ranked constraint, then the foot-head will occur further to the right.

Ranking a prosodic word alignment constraint over an oppositely specified foot-head alignment constraint means that prosodic word alignment will directly determine the position of a single foot-head. This does not mean, however, that foot-head alignment will have absolute discretion to position any remaining foot-heads. In forms with more than one foot-head, the Lapse Condition extends the conflict between prosodic word and foot-head

alignment by allowing the prosodic word constraints to indirectly restrict the position of every foot-head within a prosodic word. When the satisfaction of a prosodic word constraint demands that a syllable at the edge of a prosodic word be a foot-head, the Lapse Condition limits the distance that can occur between this syllable and other foot-heads in the form.

For example, if a foot-head must occur at a prosodic word's left edge in order to satisfy PrWd-L, one of the next two syllables to the right must also be a foot-head, one of the next two syllables after the second foot-head must also be a foot-head, and so on. This limits the conflicting Hds-Right in how far it can draw the remaining foot-heads in the form away from the initial foot-head and towards the right edge of the prosodic word:

(28) PrWd-L and the Lapse Condition

a. Lapse Cond. Not Violated

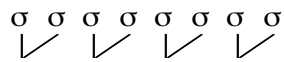

b. Lapse Condition Violated

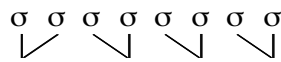

In (28), each of the examples is a prosodic word containing eight syllables, with the initial syllable being a foot-head as PrWd-L demands. Example (a), where one syllable intervenes between every foot-head, illustrates the maximal distance under the Lapse Condition that can occur between foot-heads in drawing them away from the initial foot-head and towards the right edge of the prosodic word. Example (b), where two syllables intervene between the first and second foot-heads, illustrates a situation where this limit has been exceeded. Since example (b) contains two adjacent syllables neither of which are foot-heads, this form fails the Lapse Condition and cannot be considered as an output candidate.

3.1.3.1 Maximal Alternation: Maranungku and Suruwaha

Since the effects of prosodic word alignment in disrupting the preferences of foot-head alignment are most clearly visible in maximal alternation patterns, they can be most effectively demonstrated in a more detailed examination of this type:

(29) Maximal Alternation Patterns

a. Trochaic

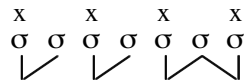
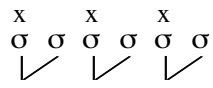

b. Iambic

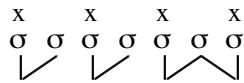
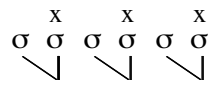

There are two important differences between the odd-parity structures posited in (29) and those presented in the brief discussion of maximal alternation in Chapter 1. The first is that both the trochaic and iambic patterns rely primarily on trochaic footing, and the second is that intersections, rather than monosyllabic feet, are used for footing the odd syllable. We will examine the reasons for this revision as we proceed.

Both the trochaic and iambic versions of maximal alternation are attested. The trochaic pattern is found in languages like Cahuilla, Icelandic (Arnason 1980, 1985; see also Hayes 1995), Maranungku (Tryon 1970; see also Hayes 1981, 1987), Ningil (Manning and Saggars 1977), and Wangkumara (McDonald and Wurm 1979). Examples from Maranungku are used to illustrate:

(30) Maranungku Forms (from Tryon 1970)

óσ	tíralk	<i>saliva</i>
óσσ̀	máeræpàt	<i>beard</i>
óσσ̀σ̀	yáŋarmàta	<i>the Pleiades</i>
óσσ̀σ̀σ̀	láŋkaràtati	<i>prawn</i>
óσσ̀σ̀σ̀σ̀	wélepènemànta	<i>kind of duck</i>

In Maranungku and each of the other trochaic maximal alternation languages, stress occurs on every odd-numbered syllable counting from the beginning of the form. In Maranungku, Cahuilla, Icelandic, and Wangkumara, the stress on the initial syllable is also the primary stress. Manning and Saggars do not mention a most prominent stress for Ningil.

The iambic maximal alternation pattern is found in languages like Suruwaha (Everett 1996), Tubatulabal (Voegelin 1935; see also Prince 1983, Kager 1993, and Crowhurst

1991), and Weru (Boxwell and Boxwell 1966; see also Hayes 1981). Suruwaha forms are used to illustrate:

(31) Suruwaha Forms (from Everett 1996)

σ́	mosá	<i>owl</i>
òσ́	bàhotá	<i>to fight</i>
σ̀σ́σ́	dakùhurú	<i>to put in the fire</i>
òσ̀σ́σ́	bìhawùhurá	<i>to fly</i>

In Suruwaha and each of the other iambic maximal alternation languages, stress occurs on every odd-numbered syllable counting from the end of the form. Also in each of these languages, the stress on the form's final syllable is also the primary stress.

Some issues that might arise in connection with maximal alternation, such as restricting the occurrence of monosyllables and intersections, have already been addressed in the discussion of foot-head alignment and minimal alternation above and would receive much the same analysis in the present context. This being the case, I will focus in the discussion that follows on issues that are distinct from those addressed earlier. The first is how the grammar determines the positions of foot-heads relative to the prosodic word in maximal alternation patterns. These positions are the same in even-parity forms as they were in minimal alternation, but they differ from minimal alternation in odd-parity forms. Here, the properties of prosodic word alignment come into play. The second issue is how the grammar positions feet in relation to foot-heads; in other words, how the grammar determines foot-type and directionality. Neither prosodic word alignment or foot-head alignment have much influence in this decision.

3.1.3.2 Odd-Parity Forms

The structure proposed for odd-parity maximal alternation patterns, both trochaic and iambic, is repeated in (32) below.

(32) Odd-Parity Maximal Alternation

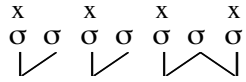

As (32) illustrates, every odd-numbered syllable is a foot-head, and each foot-head occurs with a foot-level gridmark. All feet are binary, with an intersection occurring at the right edge, and all feet except the final are trochaic. That the proposal posits identical foot structure for both trochaic and iambic odd-parity forms should not be surprising, since both foot-heads and gridmarks occur in the same positions in each type. There are two questions that we must answer, however. The first is how the foot-heads come to occupy these positions, and the second is why foot-heads with this distribution would be associated with the indicated foot pattern.

3.1.3.2.1 Location of Foot-Heads

We can begin to answer the first question by examining the relation of the maximal alternation pattern to foot-head alignment constraints. As (33) illustrates, the proposed configuration does not exhibit the best possible foot-head alignment in either direction.

(33) Hds-Left and Hds-Right

$\sigma\sigma\sigma\sigma\sigma\sigma$	Hds-Left	Hds-Right
a. $\sigma \sigma \sigma \sigma \sigma \sigma$ $\diagdown \quad \diagdown \quad \diagdown \quad \diagdown$	* ** * ** ** (9)	* ** * ** ** * ** ** ** (15)
b. $\sigma \sigma \sigma \sigma \sigma \sigma$ $\diagdown \quad \diagdown \quad \diagdown \quad \diagdown$	** ** ** * ** ** (12)	** ** ** * ** ** (12)
c. $\sigma \sigma \sigma \sigma \sigma \sigma$ $\diagdown \quad \diagdown \quad \diagdown \quad \diagdown$	* ** * ** ** * ** ** ** (15)	* ** * ** ** (9)

In (33), each example is a seven-syllable prosodic word. Example (a) exhibits the best possible leftward foot-head alignment in the system, given the length of the form, and example (c) exhibits the best possible rightward foot-head alignment. Example (b), the maximal alternation structure, occupies a kind of middle ground. It performs better on leftward alignment than (c) but not so well as (a), and it performs better on rightward alignment than (a) but not so well as (c). In some sense, the (b) example's foot-heads seem not to be drawn exclusively either leftward or rightward, but rather to be pulled in both directions at once.

This kind of conflicting directionality cannot result from foot-head alignment constraints alone. Given that they both exert influence over every foot-head in a prosodic word, as (34) demonstrates, ranking Hds-Right below Hds-Left would exclude the demands of Hds-Right, and, as (35) demonstrates, ranking Hds-Left below Hds-Right would exclude the demands of Hds-Left.

(34) Hds-Left >> Hds-Right

	σσσσσσσ	Hds-Left	Hds-Right
a.		* *** ***** (9)	* *** ***** ***** (15)
b.		** ***** *****!*** (12)	** ***** ***** (12)
c.		* *** ***** *!***** (15)	* *** ***** (9)

In (34), each of the candidates is a seven-syllable prosodic word. Candidate (a) has the best possible leftward foot-head alignment given the length of the form, and candidate (c) has the best possible rightward foot-head alignment. Candidate (b) exhibits maximal alternation footing. The higher ranked Hds-Left screens out candidates (b) and (c), so that only candidate (a) remains, and the lower ranked Hds-Right has no effect on the outcome.

(35) Hds-Right >> Hds-Left

	σσσσσσ	Hds-Right	Hds-Left
a.		<p>* ** * ** *</p> <p>* ! * ** *</p> <p>(15)</p>	<p>* ** * ** *</p> <p>(9)</p>
b.		<p>** ** * ** * ** ! ** *</p> <p>(12)</p>	<p>** ** * ** * ** *</p> <p>(12)</p>
c.		<p>* ** * ** *</p> <p>(9)</p>	<p>* ** * ** *</p> <p>** * ** *</p> <p>(15)</p>

In (35), each of the candidates are the same as in (34). This time, however, the higher ranked Hds-Right screens out candidates (a) and (b), so that only (c) remains, and the lower ranked Hds-Left has no effect on the outcome.

What the combination of prosodic word alignment and the Lapse condition accomplishes is to create a directional pressure that does not exclude other directional pressures. For example, where Hds-Left makes the demand “be as far to the left as possible”, the combination of PrWd-L and the Lapse Condition makes the weaker demand “do not be too far to the right”. This weaker injunction restricts, but does not necessarily exclude, the demands of Hds-Right. Similarly, where Hds-Right makes the demand “be as far to the right as possible”, the combination of PrWd-R and the Lapse Condition make the weaker demand “do not be too far to the left”. The weaker injunction restricts, but does not necessarily exclude, the demands of Hds-Left.

To illustrate, (36) demonstrates the effects of ranking PrWd-L over Hds-Right using the five-syllable Maranungku form /láŋkaràtati/, and (37) demonstrates the effects of ranking PrWd-R over Hds-Left using the five-syllable Suruwaha form [bìhawùhurá]. In both tableaux, only forms which comply with the Lapse Condition are considered as output candidates.

(36) PrWd-L >> Hds-Right

laŋkaratati	PrWd-L	Hds-Right
a. $\begin{array}{ccccccc} & x & & x & & x & \\ & \swarrow & & \swarrow & \searrow & \swarrow & \\ \text{la} & \text{ka} & \text{ra} & \text{ta} & \text{ti} & & \end{array}$		** *****
b. $\begin{array}{ccccccc} & & x & & x & & \\ & \swarrow & \swarrow & & \swarrow & & \\ \text{la} & \text{ka} & \text{ra} & \text{ta} & \text{ti} & & \end{array}$		* *****!*
c. $\begin{array}{ccccccc} & & x & & x & & \\ & \swarrow & & \swarrow & \swarrow & & \\ \text{la} & \text{ka} & \text{ra} & \text{ta} & \text{ti} & & \end{array}$	*!	* *****

In (36), each of the candidates exhibit a possible configuration for the five-syllable /laŋkaratati/. Candidate (a) exhibits the maximal alternation pattern. Candidate (b) has the best possible leftward alignment, given the length of the form, and candidate (c) has the best possible rightward alignment. The higher ranked PrWd-L screens out the (c) candidate—which, with rightward foot-head alignment, has no foot-head at the left edge of the prosodic word—but passes the decision between candidates (a) and (b) on to Hds-Right. Since it has fewer Hds-Right violations than the (b) candidate, candidate (a) is the winner.

(37) PrWd-R >> Hds-Left

bihawuhura	PrWd-R	Hds-Left
a. $\begin{array}{ccccccc} & x & & x & & x & \\ & \swarrow & & \swarrow & \searrow & \swarrow & \\ \text{bi} & \text{ha} & \text{wu} & \text{hu} & \text{ra} & & \end{array}$		** *****
b. $\begin{array}{ccccccc} & & x & & x & & \\ & \swarrow & \swarrow & & \swarrow & & \\ \text{bi} & \text{ha} & \text{wu} & \text{hu} & \text{ra} & & \end{array}$		* *****!*
c. $\begin{array}{ccccccc} & & x & & x & & \\ & \swarrow & \swarrow & & \swarrow & & \\ \text{bi} & \text{ha} & \text{wu} & \text{hu} & \text{ra} & & \end{array}$	*!	* *****

In (37), each of the candidates exhibits a possible configuration for the five-syllable [b̀ìhawùhurá]. Candidate (a) exhibits the maximal alternation pattern. Candidate (b) has the best possible rightward alignment, given the length of the form, and candidate (c) has the best possible leftward alignment. The higher ranked PrWd-R eliminates candidate (c)—which, with leftward foot-head alignment, has no foot-head at the right edge of the prosodic word— but passes the decision between candidates (a) and (b) on to Hds-Left. Since it has fewer Hds-Left violations than candidate (b), (a) is the winner.

Combining prosodic word alignment and the Lapse Condition exerts a limited directional pressure that allows sufficient freedom to lower ranked foot-head alignment for the maximal alternation patterns to emerge. However, since both of the rankings considered, PrWd-L >> Hds-Right and PrWd-R >> Hds-Left, each obtain the same odd-parity pattern, it is impossible to tell from odd-parity forms alone which ranking is appropriate for the iambic system and which is appropriate for the trochaic system. As we shall see in examining even-parity forms below, the rankings in the tableaux of (36) and (37) are actually paired with the appropriate systems, PrWd-L >> Hds-Right for the trochaic system and PrWd-R >> Hds-Left for the iambic system.

3.1.3.2.2 Foot-Type and Directionality

Before turning to even-parity forms, it is necessary to explain the identical footing of odd-parity forms in iambic and trochaic systems. The decision is not made by alignment constraints. The tableau in (38) compares a sampling of several possible foot patterns that might be associated with the positions of foot-heads in maximal alternation. None of the proposed alignment constraints— prosodic word or foot-head— distinguishes between the candidates. The tableau is, in fact, an example of the situation discussed in Section 3.1.2 above, where foot-head alignment’s diminished role in the placement of foot-heads corresponds to a lack of control over both foot-type and directionality.

(38) Possible Foot Structures for Maximal Alternation

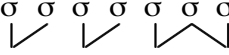
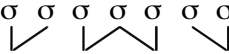
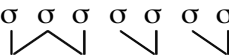
$\sigma\sigma\sigma\sigma\sigma\sigma\sigma$	PrWd- L	PrWd- R	Hds-Left	Hds-Right
a. $\sigma\ \sigma\ \sigma\ \sigma\ \sigma\ \sigma\ \sigma$ 			** **** *****	** **** *****
b. $\sigma\ \sigma\ \sigma\ \sigma\ \sigma\ \sigma\ \sigma$ 			** **** *****	** **** *****
c. $\sigma\ \sigma\ \sigma\ \sigma\ \sigma\ \sigma\ \sigma$ 			** **** *****	** **** *****

Each of the (38) candidates is a seven-syllable prosodic word with the distribution of foot-heads required for the maximal alternation pattern. Although the position of the intersection in each candidate is different, the candidates all have two considerations in common that allow their footing to be consistent with maximal alternation. The first is that the first foot in the intersection is always a trochee and the second foot in the intersection is always an iamb. The second is that the feet preceding the intersection, if any, are always trochaic, and the feet following the intersection, if any, are always iambic. Regardless of their relative number of trochees and iambs or the position of their intersection, the candidates perform identically on each of the constraints because the positions of their foot-heads are identical.

There is another constraint in the proposal, however, where the performance of the candidates will not be identical. This constraint is the foot-level version of NonFinality, which I discussed briefly in Chapter 2 and will examine more closely in Chapter 4. By demanding that stress be absent from some final element of a foot, either syllabic or moraic, this type of constraint can discriminate between iambic and trochaic feet, preferring the latter over the former.

Reconsidering the (38) candidates with respect to NonFinality in the foot, we see that the performance of candidates improves as the number of iambic feet declines:

(39) NonFinality in the Foot

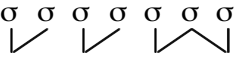
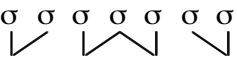
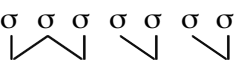
$\sigma\sigma\sigma\sigma\sigma\sigma$	NonFinality
a. $\sigma \sigma \sigma \sigma \sigma \sigma \sigma$ 	*
b. $\sigma \sigma \sigma \sigma \sigma \sigma \sigma$ 	**
c. $\sigma \sigma \sigma \sigma \sigma \sigma \sigma$ 	***

As (39) demonstrates, the form with the least violations of NonFinality in the foot is candidate (a), where all but the second foot of the intersection are trochaic. This is the same structure presented in (32) above.

In the case of odd-parity maximal alternation, then, neither foot-type nor footing directionality are actually determined by alignment constraints. Although alignment determines the positions of foot-heads within the prosodic word, these positions are compatible with a number of different footing strategies. This allows other constraints in the grammar, like NonFinality in the foot, to influence the type of footing that eventually emerges.

3.1.3.3 Even-Parity Forms

The stress patterns of even-parity forms in maximal alternation are the same as those of even-parity forms in every other type from the typology in Chapter 1. The trochaic version has stress on every odd-numbered syllable, and the iambic version has stress on every even-numbered syllable:

(40) Even-Parity Maximal Alternation

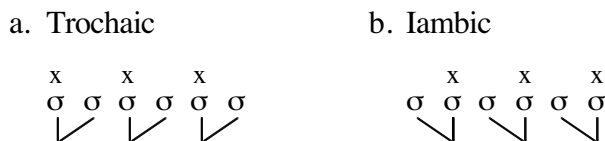

The lack of evidence in odd-parity forms for associating the appropriate ranking with iambic and trochaic systems does not extend to even-parity forms. Of the two rankings that are compatible with odd-parity patterns, only PrWd-L >> Hds-Right is also compatible with the

trochaic even-parity pattern, and only PrWd-R >> Hds-Left is also compatible with the iambic even-parity pattern.

Since the prosodic word alignment constraints are dominant in each of the two possible rankings, their demands are the most immediate and must be satisfied by any potential winner. As (41) demonstrates using the four-syllable Maranungku from /yáŋarmàta/, only the trochaic footing of (40a) satisfies PrWd-L, and as (42) demonstrates using the four-syllable Suruwaha form [dakùhurú], only the iambic footing of (40b) satisfies PrWd-R.

Only forms that comply with the Lapse Condition are considered as output candidates.

(41) PrWd-L >> Hds-Right

yaŋarmata	PrWd-L	Hds-Right
a. x x ya ŋarma ta / /		* **
b. x x ya ŋarma ta \ \	*!	**

In (41), candidate (a) is parsed using trochees, and candidate (b) is parsed using iambs. The (a) candidate's trochaic footing allows it to have a foot-head at the left edge of the prosodic word, satisfying PrWd-L, but the (b) candidate's iambic footing prevents it from having a foot-head in the desired position, violating PrWd-L. Candidate (a) correctly emerges as the winner.

(42) PrWd-R >> Hds-Left

dakuhuru	PrWd-R	Hds-Left
a. ^x da ^x ku hu ru \ \ / /		* **
b. ^x da ^x ku hu ru / \ \ /	*!	**

In (42), the (a) candidate is parsed using iambs, where the (b) candidate is parsed using trochees. Candidate (a) satisfies PrWd-R because its iambic footing allows it to have a foot-head at the right edge of the prosodic word, but candidate (b) violates PrWd-R because its trochaic footing leaves it without a foot-head in the desired position. Candidate (a) correctly emerges as the winner.

Although the lower ranked foot-head alignment constraints, as the tableaux in (41) and (42) demonstrate, have no role in choosing between the trochaic and iambic options, they have considerable effect in screening out additional options that might satisfy the higher ranked prosodic word alignment constraints. With the ranking PrWd-L >> Hds-Right, for example, there must be a foot-head at the left edge of the prosodic word, but Hds-Right is still able to draw the second foot-head of /yáŋarmàta/ far enough to the right that additional foot-heads, and the monosyllables or intersection that would accompany them, are not needed to parse the form. What Hds-Right cannot do in this situation is draw the foot-head so far to the right that the second foot of /yáŋarmàta/ would be iambic. Such a form would violate the Lapse Condition and could not be considered as an output candidate. Similarly with the ranking PrWd-R >> Hds-Left, there must be a foot-head at the right edge of the prosodic word, but Hds-Left draws the remaining foot-head of [dakùhurú] far enough to the left that additional foot-heads, and the accompanying monosyllables or intersection, are not necessary to parse the form. Due to the Lapse Condition, however, Hds-Left

cannot draw the foot-head so far to the right that the first foot of [dakùhurú] becomes a trochee. The effect of foot-head alignment in this context, then, is already familiar. It establishes the non-intersected binary footing of even-parity forms.

For the sake of completeness, and before moving on, we should examine the role of the other core constraints— MapGM (Ft) and *Clash— in obtaining the maximal alternation patterns. As we saw above, MapGM (Ft) and *Clash were crucial in producing the gridmark sharing configurations in minimal alternation odd-parity forms, allowing trochaic and iambic minimal alternation to harmonically bound competitors that either violated the foot-stress relationship or resulted in a clash configuration. Given the spacing between foot-heads in maximal alternation patterns, however, considerations that might result in a clash configuration or a violation of the foot-stress relationship do not arise.

As (43) demonstrates, only the directional considerations resulting from the ranking PrWd-L >> Hds-Right distinguish the trochaic maximal alternation pattern from its minimal alternation counterparts.

(43) Trochaic: MapGM (Ft), *Clash, PrWd-L >> Hds-Right

	σσσσσσ	MapGM (Ft)	*Clash	PrWd-L	Hds-Right
a.	$\begin{array}{cccccc} & x & & x & & x & & x \\ \sigma & \sigma & \sigma & \sigma & \sigma & \sigma & \sigma & \sigma \\ & \swarrow & & \swarrow & & \swarrow & \searrow & \swarrow \end{array}$				<p>** ***** ***** (12)</p>
b.	$\begin{array}{cccccc} & x & & x & & x \\ \sigma & \sigma & \sigma & \sigma & \sigma & \sigma & \sigma & \sigma \\ & \swarrow & \swarrow & \swarrow & \swarrow & \swarrow & \swarrow & \swarrow \end{array}$				<p>* *** ***** *****!*** (15)</p>
c.	$\begin{array}{cccccc} & x & & x & & x \\ \sigma & \sigma & \sigma & \sigma & \sigma & \sigma & \sigma & \sigma \\ & \swarrow & & \swarrow & & \swarrow & \swarrow & \swarrow \end{array}$			*!	<p>* *** ***** (9)</p>

In (43), the (a) candidate exhibits the trochaic maximal alternation pattern, the (b) candidate the trochaic minimal alternation pattern, and the (c) candidate the iambic minimal alternation pattern. Since none of the candidates violate either constraint, neither MapGM (Ft) nor *Clash have any effect on the outcome, and their ranking is not crucial. PrWd-L screens out

the iambic minimal alternation (c) and passes the decision between (a) and (b) on to Hds-Right. Hds-Right screens out the trochaic minimal alternation (b) and leaves the trochaic maximal alternation (a) as the winner.

Similarly, as (44) demonstrates, only the directional considerations produced by the ranking PrWd-R >> Hds-Left distinguish the iambic maximal alternation pattern from its minimal alternation counterparts.

(44) Iambic: MapGM (Ft), *Clash, PrWd-R >> Hds-Left

	σσσσσσ	MapGM (Ft)	*Clash	PrWd-R	Hds-Left
a.	$\begin{array}{cccccc} & x & & x & & x & & x \\ \sigma & \sigma & \sigma & \sigma & \sigma & \sigma & \sigma & \sigma \\ & \swarrow & & \swarrow & & \swarrow \searrow & & \swarrow \searrow \end{array}$				** **** ***** (12)
b.	$\begin{array}{cccccc} & x & & x & & x \\ \sigma & \sigma & \sigma & \sigma & \sigma & \sigma \\ & \swarrow \searrow & & \swarrow & & \swarrow \end{array}$			* !	* *** ***** (9)
c.	$\begin{array}{cccccc} & x & & x & & x \\ \sigma & \sigma & \sigma & \sigma & \sigma & \sigma \\ & \swarrow & & \swarrow & & \swarrow \searrow \end{array}$				* *** ***** *****!*** (15)

In (44), the (a) candidate exhibits the iambic maximal alternation pattern, the (b) candidate the trochaic minimal alternation pattern, and the (c) candidate the iambic minimal alternation pattern. Since none of the candidates violate either constraint, MapGM (Ft) and *Clash have no influence over the outcome, and their ranking is not crucial. PrWd-R screens out the trochaic minimal alternation (b), passing the decision between (a) and (c) on to Hds-Left. Hds-Left screens out the iambic minimal alternation (c), leaving the iambic maximal alternation (a) as the winner.

To summarize, we have seen in this part of the discussion that introducing PrWd-L and PrWd-R to the constraint set allows the grammar to disrupt the default connection between foot-type and footing directionality established by Hds-Left and Hds-Right. The combination of prosodic word alignment and the Lapse Condition produce a kind of directional pressure that does not totally exclude contrary demands made by lower ranked foot-

head alignment constraints. Such rankings produce the conflicting directionality characteristic of the symmetrically attested maximal alternation patterns.

3.1.4 Direct Restrictions

There are several types of restrictions that we might reasonably place on alignment constraints. As the theory proposed here involves multiple distinguishable systems and the interactions between them, I will frame the restrictions either in terms of general limitations on how alignment constraints may refer to these systems or in terms of specific limitations in the context of interaction between two systems. For example, alignment might be able to refer only to a subset of the elements in a given system. This restriction might apply generally, or it might apply only to situations of interaction between the system in question and some other particular system. The elements of a given system might also be eligible only for one of the two types of quantification, either existential or universal. This type of restriction, too, might apply generally or only to specific interactions.

Although I will posit no general restriction on alignment's ability to refer to prosodic heads, alignment's ability to refer to prosodic categories is much more limited in the proposed account than it is in the standard approach. In fact, the prosodic word is the only prosodic category that has been or will be extensively utilized in the alignment constraints proposed here. This circumstance is partly incidental, arising from a focus on the lower levels of the hierarchy, but it is also partly by design. For reasons I will discuss below, alignment constraints must be unable to refer to feet. There is also seemingly little reason— at least in the context of metrical theory— for alignment to refer to syllables or moras. This being the case, alignment will be restricted in its access to a subset of the prosodic hierarchy including only the prosodic word and higher categories:

(45) Restriction on Reference to the Prosodic Hierarchy

Alignment constraints may only refer to levels of the prosodic hierarchy above the foot.

Since the proposal focuses on the lower levels of the hierarchy, there will be little discussion of constraints referring to prosodic categories other than the prosodic word.

We have seen above how foot-head alignment constraints are able to simultaneously influence foot-type and footing directionality. Just as important to the proposed account, however, is the stronger position that alignment constraints cannot influence foot-type and footing directionality independently. In Chapter 1, we saw that independent, symmetrical influences over these two factors allow the standard account to generate a much larger range of stress patterns than is actually attested, and although considerations such as Strict Succession and the toleration of improper bracketing make the proposed account substantially more restrictive at the outset, they do not make it immune to the same types of problems on a smaller scale.

The four alignment constraints proposed thus far— Hds-Left, Hds-Right, PrWd-L, and PrWd-R— together have the ability to produce only two types of patterns in a symmetrical fashion. They can produce the trochaic and iambic versions of minimal alternation and the trochaic and iambic versions of maximal alternation. In each of these patterns, both foot-type and directionality are determined either by the properties of foot-head alignment or the properties of NonFinality within the foot. The two factors are not independent.

If it were the case, however, that constraints— such as the pair in (46)— aligning the edges of feet with the prosodic word existed alongside those aligning the edges of foot-heads with the prosodic word, the possibility of independently specifying foot-type and footing directionality would creep back into the grammar.

(46) Foot Alignment Constraints

Align (Ft, L, PrWd, L): the left edge of every foot is aligned with the left edge of some prosodic word.

Align (Ft, R, PrWd, R): the right edge of every foot is aligned with the right edge of some prosodic word.

If ranked highly enough, foot alignment would be able to determine footing directionality while foot-head alignment would retain its influence over foot-type.

In particular, the grammar would be able to obtain both of the internal ternary patterns, although the iambic version is unattested. The iambic pattern would emerge when leftward foot alignment ranked above rightward foot-head alignment. Leftward foot alignment would demand leftward footing, and rightward foot-head alignment would demand an iambic foot-type:

(47) Align (Ft, L, PrWd, L) >> Hds-Right

$\sigma\sigma\sigma\sigma\sigma\sigma$	Align (Ft, L)	Hds-Right
a. $\begin{array}{cccccc} & x & & x & & x \\ \sigma & \sigma & \sigma & \sigma & \sigma & \sigma \\ & \diagdown & \diagup & \diagdown & \diagup & \diagdown \end{array}$	* * * * * (9)	** * * * * * (11)
b. $\begin{array}{cccccc} x & & x & & x & & x \\ \sigma & \sigma & \sigma & \sigma & \sigma & \sigma & \sigma \\ & \diagup & \diagdown & \diagup & \diagdown & \diagup & \diagdown \end{array}$	* * * * * (9)	** * * * * *! (12)
c. $\begin{array}{cccccc} & x & & x & & x \\ \sigma & \sigma & \sigma & \sigma & \sigma & \sigma \\ & \diagup & \diagdown & \diagup & \diagdown & \diagup \end{array}$	* * * * * (9)	* * * * * * * * * *! (15)
d. $\begin{array}{cccccc} & x & & x & & x \\ \sigma & \sigma & \sigma & \sigma & \sigma & \sigma \\ & \diagdown & \diagup & \diagdown & \diagup & \diagdown \end{array}$	** * * * * *! (11)	* * * * * (9)

In (47), candidate (d), a minimal alternation pattern with iambic footing and rightward directionality, has the best possible rightward foot-head alignment given the length of the form. It drops out first at Align (Ft, L), however, because its feet are not as well aligned as candidates (a-c). Candidate (c), also a minimal alternation pattern, drops out next because its trochaic footing produces more Hds-Right violations than the (a) candidate's iambic footing. Similarly, candidate (b), a maximal alternation pattern, drops out because its initial trochee incurs more violations of Hds-Right than the (a) candidate's initial iamb. Candidate (a), the iambic internal ternary pattern, is the winner.

Given such predictions, it is crucial to the proposed account's restrictiveness that alignment relationships between feet and prosodic words be absent from the grammar. For somewhat different reasons, it is also necessary that alignment relationships between feet and foot-heads be absent. For example, if there were alignment constraints between heads of

feet and feet themselves— Align (Ft-Hd, L, Ft, L) and Align (Ft-Hd, R, Ft, R)— we would predict some complications in the typology that it seems best to avoid. In particular, a grammar where Align (Ft-Hd, L, PrWd, L) and Align (Ft-Hd, R, Ft, R) ranked above both Hds-Left and Hds-Right would produce forms parsed entirely by monosyllables. This is illustrated for an even-parity form in (48).

(48) Align (Ft-Hd, R, Ft, R), Align (Ft-Hd, L, Ft, L)

$\sigma\sigma\sigma\sigma$	Align (Ft-Hd, R)	Align (Ft-Hd, L)	Hds-Right	Hds-Left
a. $\sigma \ \sigma \ \sigma \ \sigma$ 			* * * * *	* * * * *
b. $\sigma \ \sigma \ \sigma \ \sigma$ $\diagdown \ \diagdown$		* ! *	* *	* * * *
c. $\sigma \ \sigma \ \sigma \ \sigma$ $\diagup \ \diagup$	* ! *		* * * *	* *

Each of the (48) candidates is a four-syllable prosodic word. Candidate (a) is parsed by four monosyllabic feet, candidate (b) by two iambic feet, and candidate (c) by two trochaic feet. In candidate (c), neither foot-head is aligned with the right edge of a foot, resulting in two violations of Align (Ft-Hd, R, Ft, R). Since neither (a) or (b) have violations of this constraint, (c) drops out. In candidate (b), neither foot-head is aligned with the left edge of a foot, resulting in two violations of Align (Ft-Hd, L, Ft, L). Since (a) does not violate this constraint, (b) drops out as well, and (a) is the winner. Given their low ranking, Hds-Left and Hds-Right do not have a chance to influence the outcome.

If ranked highly enough, alignment constraints between foot-heads and feet could screen out candidates with disyllabic feet. This type of foot pattern might lead to several different stress patterns, among them a pattern where every syllable receives a secondary stress. Another possibility is that clash avoidance might produce alternating stress in ways that the properties of metrical grid alone determine. Although these options are not necessarily pathological (it may be impossible to distinguish a string of syllables each with secondary stress from a string of syllables each without stress), it is clear that the theory can

produce the desired patterns without them, and it is certainly simpler from a practical standpoint to disallow them.

3.2 Prosodic Word-Head Alignment

Although we have seen how prosodic word and foot-head alignment constraints influence the distribution of stress in minimal and maximal alternation languages, we have not yet seen how the proposal determines the particular position of primary stress. Most of the burden in making this decision falls to two additional constraints, Hd-Right and Hd-Left, which position the prosodic word-head within the prosodic word itself. These are defined in (49).

(49) PrWd-Head Alignment

Hd-Left or Align (PrWd-Hd, L, PrWd, L): the left edge of every prosodic word-head is aligned with the left edge of some prosodic word.

Hd-Right or Align (PrWd-Hd, R, PrWd, R): the right edge of every prosodic word-head is aligned with the right edge of some prosodic word.

Since prosodic word-level gridmarks must correspond to the heads of prosodic words, the prosodic word-head alignment constraints are the primary mechanisms determining the position of primary stress.

There is an important difference between the constraints of (49) and the foot-head alignment constraints discussed above. Because foot-heads were aligned not within feet themselves but within the larger prosodic word, both the head's position within the foot and the foot's position within the prosodic word were potentially relevant to success with respect to foot-head alignment constraints. Because the prosodic word-head is aligned within the prosodic word itself, however, only the head's position within the prosodic word is relevant to success with respect to prosodic word-head alignment constraints.

To illustrate, (50) compares with respect to both Hd-Left and Hd-Right the possible positions of the head in a prosodic word with three feet.

(50) Hd-Left and Hd-Right

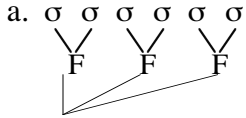
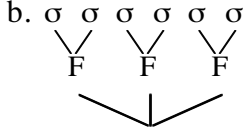
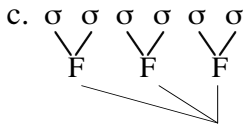
	Hd-Left	Hd-Right
a. 		****
b. 	**	**
c. 	****	

In (50), each of the three candidates is a six-syllable prosodic word parsed into three feet. In candidate (a), the initial foot is the head of the prosodic word; In candidate (b), the middle foot is the head; and, in candidate (c), the final foot is the head. Since the left edge of the (a) candidate's prosodic word-head is perfectly aligned with the left edge of the prosodic word, this candidate incurs no Hd-Left violations. As the head moves further away from the left edge in (b) and (c), however, the number of violations increases. When these same candidates are compared with respect to Hd-Right, candidate (c) incurs no violations, since the right edge of its head is exactly aligned with the right edge of the prosodic word. The number of violations increases as the head moves away from the right edge of the prosodic word in (b) and (a).

Since prosodic word-level gridmarks must occur within the domain of a prosodic word-head, in accordance with the Gridmark to Head Condition, the position in which this head occurs limits the position in which the gridmark may occur. If, for example, the head of the prosodic word is its initial foot, as Hd-Left demands, then the prosodic word-level gridmark must fall within the domain of the initial foot, but if the prosodic word-head is the final foot, as Hd-Right demands, then the prosodic word-level gridmark must fall within the domain of the final foot.

In Nengone and the other trochaic minimal alternation languages (except for Wargamay), the final stress in a form is also the primary stress. This stress always occurs on the penultimate syllable and within the domain of the final foot. The correct pattern emerges by aligning the head of the prosodic word to the right, as (51) demonstrates using the four-syllable Nengone form /ačakáze/ and as (52) demonstrates using the five-syllable Nengone form /wačaruwíwi/.

(51) Even-Parity: Hd-Right

ačakaze	Hd-Right
<p>a. a ča ka ze</p> <p>Foot-level gridmarks (F) are under 'a' and 'ka'. A prosodic word-level gridmark (x) is under 'ka'. A larger 'x' is under 'ze'.</p>	
<p>b. a ča ka ze</p> <p>Foot-level gridmarks (F) are under 'a' and 'ka'. A prosodic word-level gridmark (x) is under 'a'. A larger 'x' is under 'ze'.</p>	*!*

In (51), both candidates display the distribution of foot-level gridmarks predicted by the analysis above for four-syllable forms in Nengone. An entry occurs over both the first and third syllables. The candidates differ, however, in both the location of the prosodic word-head and the position of the prosodic word-level gridmark. In candidate (a), the final foot is the prosodic word-head, and a prosodic word-level gridmark occurs over the third syllable. In candidate (b), the initial foot is the prosodic word-head, and a prosodic word-level gridmark occurs over the first syllable. Since the prosodic word-head in (b) is further from the right edge than the prosodic word-head of (a), (b) has more Hd-Right violations, and (a) correctly emerges as the winner.

(52) Odd-Parity: Hd-Right

wačaruwiwi	Hd-Right
<p>a. wa ča ru wi wi</p> <p>b. wa ča ru wi wi</p>	<p>*!***</p>

In (52), the two candidates exhibit the distribution of foot-level gridmarks predicted by the analysis above for five-syllable forms in Nengone. Entries occur over the second and fourth syllables. In the (a) candidate, the final foot is the prosodic word-head, and the prosodic word-level gridmark occurs over the fourth syllable. In the (b) candidate, the initial foot is the prosodic word-head, and the prosodic word-level gridmark occurs over the second syllable. As the head of the prosodic word in (b) is further from the right edge than the head of the prosodic word in (a), (b) incurs more Hd-Right violations, and (a) correctly emerges as the winner.

In the iambic minimal alternation language Araucanian, the initial stress of a form is also the primary stress. This stress always occurs on the peninitial syllable and within the domain of the initial foot. Obtaining this pattern simply means aligning the prosodic word-head to the left, as (53) demonstrates using the four-syllable /elúmuyù/ and as (54) demonstrates using the five-syllable /elúaènew/.

(53) Even-Parity: Hd-Left

elumuyu	Hd-Left
<p>a. e lu mu yu</p> <p>x x x F F </p>	
<p>b. e lu mu yu</p> <p>x x x F F </p>	*!*

In (53), the two candidates display the distribution of foot-level gridmarks that the analysis above predicts for a four-syllable Araucanian form. An entry occurs on both the second and fourth syllables. The two candidates differ, however, in both the location of the prosodic word-head and the position of the prosodic word-level gridmark. In the (a) candidate, the initial foot is the prosodic word-head, and the prosodic word-level gridmark occurs over the second syllable. In the (b) candidate, the final foot is the prosodic word-head, and the prosodic word-level gridmark occurs over the fourth syllable. Since the (b) candidate's prosodic word-head is further away from the left edge than the (a) candidate's, (b) has more Hd-Left violations, and (a) correctly emerges as the winner.

(54) Odd-Parity: Hd-Left

eluaenew	Hd-Left
<p style="text-align: center;"> x x x a. e lu a e new F F F </p> <p style="text-align: center;"> x x b. e lu a e new F F F </p>	<p>*!***</p>

In (54), both candidates exhibit the distribution of foot-level gridmarks that the analysis above predicts for a five-syllable Araucanian form. Entries occur on the second and fourth syllables. In candidate (a), the initial foot is the prosodic word-head, and the prosodic word-level gridmark occurs over the second syllable. In candidate (b), the final foot is the prosodic word-head, and the prosodic word-level gridmark occurs over the fourth syllable. Since the prosodic word-head in candidate (b) is further away from the left edge than the prosodic word-head in candidate (a), (b) has more Hd-Left violations, and (a) correctly emerges as the winner.

Similar analyses obtain the correct predictions for maximal alternation languages. In Maranungku and the other trochaic languages, the head of the prosodic word is aligned to the left, and in Suruwaha and the other iambic languages, the head of the prosodic word is aligned to the right:

(55) Main Stress in Maximal Alternation Languages

a. Hd-Left (Maranungku)

b. Hd-Right (Suruwaha)

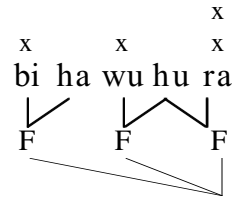
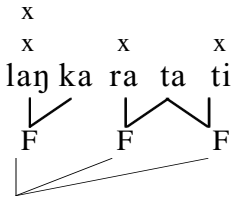
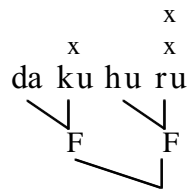
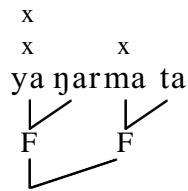

For the (55a) Maranungku forms, Hd-Left demands that the initial foot be the head of the prosodic word, and the prosodic word-level gridmark occurs over the foot-level gridmark associated with the head foot. For the (55b) Suruwaha forms, Hd-Right demands that the final foot be the head of the prosodic word, and the prosodic word-level gridmark occurs over the foot-level gridmark associated with the head foot.

3.3 Gridmark Alignment

The alignment constraints that we have examined thus far have made reference to only two of the three systems discussed in Chapter 2— the prosodic hierarchy and the system of prosodic prominence. In the discussion that follows, we will examine both the uses for and the restrictions on alignment constraints that refer to the metrical grid. The usefulness of gridmark alignment in the proposed account is based on alignment’s preference for minimal structure as well as alignment’s directionality effects. Alignment’s ability to limit the number of gridmark entries in a form will be crucial in obtaining “unbounded” stress systems, amphibrach-type ternary patterns, and monopositionally-mapped heavy syllables. As was the case with the prosodic hierarchy, there are substantial restrictions on the ways that alignment constraints can refer to the metrical grid. Unlike the prosodic hierarchy, however,

it is the higher levels of the grid, rather than the lower levels, that are excluded from participation.

3.3.1 Alignment of Mora-Level Gridmarks

We begin with the moraic level of the grid, the grid's base level, and the following pair of mora-gridmark alignment constraints:

(56) Mora-Level Gridmark Alignment

MG-Left or Align (Ft-GM, L, PrWd, L): the left edge of every mora-level gridmark is aligned with the left edge of some prosodic word.

MG-Right or Align (Ft-GM, R, PrWd, R): the right edge of every mora-level gridmark is aligned with the right edge of some prosodic word.

The (56) constraints demand that the appropriate edges of all mora-level gridmarks be aligned with the appropriate edge of some prosodic word. In particular, MG-Left demands that the left edge of all mora-level gridmarks be aligned with the left edge of a prosodic word, and MG-Right demands that the right edge of all mora-level gridmarks be aligned with the right edge of a prosodic word.

Vacuous and non-vacuous satisfaction are both potential options for these constraints, as (57) demonstrates using MG-Right.

(57) Satisfaction of MG-Right

μμμμ	MG-Right
a. μ μ μ μ	
b. μ μ μ μ ^x	

In (57), the (a) candidate illustrates vacuous satisfaction, and the (b) candidate illustrates non-vacuous satisfaction. Because candidate (a) has no mora-level gridmarks, and the constraint does not require them to be present, there is nothing to cause MG-Right violations. Although candidate (b) has a mora-level gridmark with the potential to incur violations, this

solitary gridmark is exactly aligned with the prosodic word's right edge and thus produces no violations.

Much like Strict Succession prevents vacuous satisfaction of foot-head, prosodic word-head, and prosodic word alignment, the Head Mora Condition prevents vacuous satisfaction of mora-gridmark alignment. Since the Head Mora Condition demands that the head of every syllable be associated with a mora-level gridmark, and since there must be at least one syllable in every form, there will always be at least one mora-level gridmark in every form.

Violations of mora-gridmark alignment are incurred as a moraic-level gridmark moves away from the designated edge, as (58) demonstrates using MG-Right, and as more entries are added at greater distances from the designated edge, as (59) demonstrates also using MG-Right.

(58) Violation of MG-Right (Single Entry)

μμμμμμμμ	MG-Right
a. μ μ μ μ μ μ μ μ ^x	
b. μ μ μ μ μ μ μ μ ^x	**
c. μ μ μ μ μ μ μ μ ^x	****
d. μ μ μ μ μ μ μ μ ^x	*****

The tableau in (58) demonstrates that the further a mora-level gridmark occurs from the right edge of the prosodic word, the more MG-Right violations (measured in intervening moras) it incurs. In candidate (a), the entry occurs at the right edge, and no violations are assessed. As the entry moves further away in candidates (b-d), the number of violations increases.

(59) Violation of MG-Right (Multiple Entries)

μμμμμμμμ	MG-Right
a. μ μ μ μ μ μ μ μ x	
b. μ μ μ μ μ μ μ μ x x	**
c. μ μ μ μ μ μ μ μ x x x	** ****
d. μ μ μ μ μ μ μ μ x x x x	** **** ******

The tableau in (59) demonstrates that additional entries also increase the number of violations that a form incurs. In candidate (a), a single gridmark occurs at the right edge of the prosodic word, and there are no violations. As more gridmarks are added at greater distances in candidates (b-d), however, the number of violations multiplies.

The preference of mora-gridmark alignment for a minimal number of entries on the grid's base level may have a substantial impact on the behavior of heavy syllables. Not all moras are head moras (in heavy syllables there is at least one non-head mora), and the association of non-head moras with gridmarks is governed by the violable MapGM (Mora) constraint. If ranked highly enough, mora-gridmark alignment may prevent any non-head moras in a syllable from associating with gridmark entries.

3.3.1.1 Monopositional and Bipositional Mapping

In Chapter 2, we saw that the difference between monopositional and bipositional mapping for heavy syllables has consequences in potential clash configurations. A stressed bipositionally-mapped syllable can immediately precede another stressed syllable without violating *Clash, but a stressed monopositionally mapped syllable cannot. In the discussion that follows we will examine two familiar examples, demonstrating the interactions that produce the different mappings in the first place.

Recall the examples presented in Chapter 2 from Wargamay and Cahuilla, two trochaic languages that do not typically tolerate clash:

(60) Heavy Syllables in Wargamay and Cahuilla

a. Wargamay

 H̄ L L gí:baɽa *fig tree*

b. Cahuilla

 H̄ L̄ L háʔtìsqal *he is sneezing*

In (60), both examples are three-syllable forms with an initial heavy syllable preceding two light syllables. In Wargamay, even though the two light syllables could form a trochee, only the heavy syllable is stressed, but, in Cahuilla, both the heavy syllable and the following light syllable are stressed.

We can explain the difference between the two types by positing different mappings for the heavy syllables. Heavy syllables in Wargamay, as (61a) illustrates, would be monopositionally mapped, and heavy syllables in Cahuilla, as (61b) illustrates, would be bipositionally mapped.

(61) Monopositional vs. Bipositional Mapping

a. Wargamay



b. Cahuilla

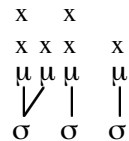

For the purposes of measuring clash, heavy syllables in Wargamay would behave just like light syllables. Because there would be no entry on the base level between the two foot-level entries, a stressed heavy syllable cannot immediately precede another stressed syllable without producing a clash configuration. If clash is to be avoided, as it apparently must be in Wargamay, the syllable following the heavy syllable cannot be stressed. In Cahuilla, bipositional mapping creates an entry on the base level between the two foot-level entries, so that there is no clash configuration to avoid.

The question that concerns us here is how the grammar actually produces the two different mappings. There are several interactions that can produce the desired results, but I will focus here on the interaction between mora-gridmark alignment and MapGM (Mora). When ranked above mora-gridmark alignment, as (62) demonstrates using MG-Left, MapGM (Mora) ensures that all non-head moras will correspond to gridmarks. This produces bipositional mapping like that in Cahuilla. When the ranking is reversed, however, as (63) demonstrates, MG-Left prevents non-head moras from associating with gridmarks. This produces monopositional mapping like that in Wargamay.

(62) MapGM (Mora) >> MG-Left

	MapGM (Mora)	MG-Left
a. $\begin{array}{cccc} & x & x & x & x \\ & \mu & \mu & \mu & \mu \\ & \vee & & & \\ \sigma & & \sigma & & \sigma \end{array}$		$\begin{array}{ccc} * & ** & *** \\ (6) \end{array}$
b. $\begin{array}{ccc} & x & & x & & x \\ & \mu & \mu & \mu & \mu \\ & \vee & & & \\ \sigma & & \sigma & & \sigma \end{array}$	*!	$\begin{array}{ccc} ** & & *** \\ (5) \end{array}$

In (62), each candidate is a three-syllable prosodic word with an initial heavy syllable preceding two light syllables. The difference between them is that the (a) candidate's heavy syllable is bipositionally mapped where the (b) candidate's heavy syllable is monopositionally mapped. The (b) candidate's missing gridmark allows it to do better than the (a) candidate with respect to MG-Left, but it also causes (b) to violate MapGM (Mora) where (a) does not. Since MapGM (Mora) is the higher ranked constraint, (a) is the winner.

(63) MG-Left >> MapGM (Mora)

	MG-Left	MapGM (Mora)
a. $ \begin{array}{cccc} & x & x & x & x \\ & \mu & \mu & \mu & \mu \\ & \swarrow & & & \\ & \sigma & \sigma & \sigma & \end{array} $	* ** ***! (6)	
b. $ \begin{array}{ccc} & x & x & x \\ & \mu & \mu & \mu \\ & \swarrow & & \\ & \sigma & \sigma & \sigma \end{array} $	** *** (5)	*

In (63), the candidates are the same as those in (62), but the ranking is reversed. The (a) candidate's additional gridmark allows it to perform better than the (b) candidate with respect to MapGM (Mora), but it also causes (a) to have more MG-Left violations than (b). Since MG-Left is the higher ranked constraint, (b) is the winner.

When ranked highly enough, mora-gridmark alignment promotes monopositional mapping for heavy syllables over bipositional mapping. Clash avoidance is not the only aspect of the theory, however, where the impact of mora-gridmark alignment will be felt. Mora-gridmark alignment, monopositional mapping, and bipositional mapping are all important components in the analysis of “defaults-to-opposite-side” stress systems to be presented in Chapter 5.

3.3.2 Alignment of Foot-Level Gridmarks

The second pair of gridmark alignment constraints that we will consider are given in (64).

(64) Foot-Level Gridmark Alignment

FG-Left or Align (Ft-GM, L, PrWd, L): the left edge of every foot-level gridmark is aligned with the left edge of some prosodic word.

FG-Right or Align (Ft-GM, R, PrWd, R): the right edge of every foot-level gridmark is aligned with the right edge of some prosodic word.

Both constraints demand alignment between the appropriate edge of all foot-level gridmarks and the appropriate edge of some prosodic word. FG-Left demands that the left edge of each foot-level gridmark be aligned with the left edge of a prosodic word, and FG-Right

demands that the right edge of each foot-level gridmark be aligned with the right edge of a prosodic word.

As with the alignment constraints considered previously, there are potentially two ways to satisfy foot-gridmark alignment: vacuously and non-vacuously. In (65), candidate (a) illustrates vacuous satisfaction of FG-Right, and candidate (b) illustrates non-vacuous satisfaction.

(65) Satisfaction of FG-Right

$\sigma\sigma\sigma\sigma$	FG-Right
a. $\sigma \ \sigma \ \sigma \ \sigma$	
b. $\sigma \ \sigma \ \sigma \ \overset{x}{\sigma}$	

In (65), candidates (a) and (b) are both four-syllable prosodic words. Since candidate (a) has no foot-level gridmarks, and the constraint does not require foot-level gridmarks to be present, there can be no FG-Right violations. The (b) candidate, however, does contain a foot-level gridmark with the potential to violate FG-Right, but since this single gridmark is exactly aligned with the right edge of the prosodic word, no violations are incurred.

Unlike the constraints considered previously, vacuous satisfaction is possible with foot-level gridmark alignment. Strict Succession applies directly to the prosodic hierarchy, and therefore indirectly also to prosodic heads, but it does not apply to the metrical grid. Neither does the Head Mora Condition apply to foot-level gridmarks. The mechanism primarily responsible for constructing the grid's upper levels is the violable MapGridmark family of constraints. If these constraints do not rank highly enough, gridmark entries may be absent from the foot level, as in (65a), and FG-Left and FG-Right can be vacuously satisfied.

A form incurs violations of foot-gridmark alignment when a foot-level gridmark occurs away from the designated edge of the prosodic word. The greater the number of such

gridmarks, the greater the number of alignment violations. FG-Right is used to illustrate below:

(66) Violations of FG-Right (Single Gridmark)

σσσσσσσσ	FG-Right
a. σ σ σ σ σ σ σ σ ^x	
b. σ σ σ σ σ σ σ σ ^x	**
c. σ σ σ σ σ σ σ σ ^x	****
d. σ σ σ σ σ σ σ σ ^x	*****

(67) Violations of FG-Right (Multiple Gridmarks)

σσσσσσσσ	FG-Right
a. σ σ σ σ σ σ σ σ ^x	
b. σ σ σ σ σ σ σ σ ^x ^x	**
c. σ σ σ σ σ σ σ σ ^x ^x ^x	** ****
d. σ σ σ σ σ σ σ σ ^x ^x ^x ^x	** **** *****

The tableaux in (66) and (67) show FG-Right violations occurring in two ways. First, (66) demonstrates that moving a single foot-level gridmark away from the designated edge of alignment increases the number of alignment violations. The gridmark of candidate (a) occurs at the right edge of the prosodic word, and there are no violations FG-Right. As the gridmark moves away from the right edge in candidates (b-d) the number of violations increases. Second, (67) demonstrates that foot-level gridmarks in addition to the one exactly aligned increase the number of violations. The (a) candidate has a single foot-level gridmark

at the right edge of the prosodic word, and no violations are incurred. As more entries are added at greater distances in candidates (b-d), the number of violations increases according to the distances and the number of entries involved.

This last phenomenon is what gives foot-gridmark alignment its preference for a minimal amount of structure. In general, the fewer foot-level gridmarks there are in a prosodic word, the better the form does with respect to foot-gridmark alignment. In the discussion of unbounded and ternary stress systems that follows, we will see two strategies for minimizing the number of gridmark entries on the foot level.

3.3.2.1 Interactions

In addition to the binary patterns we have been examining thus far, the theory of metrical stress must account for attested ternary and unbounded patterns. In binary patterns, illustrated in (68a), one stress occurs for every two syllables in a form.

(68) Binary *vs.* Ternary *vs.* Unbounded

a. Binary Pattern	b. Ternary Pattern	c. Unbounded Pattern
$\begin{array}{cccccc} \text{x} & & \text{x} & & \text{x} & \\ \sigma & \sigma & \sigma & \sigma & \sigma & \sigma \end{array}$	$\begin{array}{cccccc} & & \text{x} & & & \\ \sigma & \sigma & \sigma & \sigma & \sigma & \sigma \end{array}$	$\begin{array}{cccccc} & & & & \text{x} & \\ \sigma & \sigma & \sigma & \sigma & \sigma & \sigma \end{array}$

In ternary patterns, illustrated in (68b), stress occurs only once for every three syllables in a form, and in unbounded patterns, illustrated in (68c), stress occurs only once per form.

Adding foot-gridmark alignment to the constraint set introduces interactions allowing the proposed account to meet this burden. Foot-gridmark alignment has two properties that are relevant in this respect. The first and most important is that, like other alignment constraints, it prefers a minimal amount of structure. In particular, it prefers a minimal number of foot-level gridmarks. The second is the directional influence that foot-gridmark alignment exerts over foot-level gridmarks. Because foot-level gridmarks must correspond to the heads of feet, under certain conditions, foot-gridmark alignment will influence foot-type and footing directionality.

3.3.2.1.1 Minimal Structure

Of the core constraints that I have introduced to this point, there are significant interactions between foot-gridmark alignment constraints and MapGM (Ft) and significant interactions between foot-gridmark alignment constraints and foot-head alignment constraints. Consider first the competing preferences of foot-gridmark alignment constraints and MapGM (Ft). In competitions between a candidate with stressed feet, such as (69a) below, and a candidate with stressless feet, such as (69b), foot-gridmark alignment will prefer the candidate with stressless feet, and MapGM (Ft) will prefer the candidate with stressed feet. FG-Right illustrates the effects of foot-gridmark alignment.

(69) FG-Right and MapGM (Ft)

$\sigma\sigma\sigma\sigma\sigma$	FG-Right	MapGM (Ft)
a. $\begin{array}{cccccc} & x & & x & & x \\ \sigma & \sigma & \sigma & \sigma & \sigma & \sigma \\ & \diagdown & & \diagdown & & \diagdown \end{array}$	** *****	
b. $\begin{array}{cccccc} & & & & & x \\ \sigma & \sigma & \sigma & \sigma & \sigma & \sigma \\ & \diagdown & & \diagdown & & \diagdown \end{array}$		**

In (69), both candidates are six-syllable prosodic words parsed by three feet. Although the (a) candidate's multiple foot-level gridmarks produce multiple FG-Right violations, MapGM (Ft) prefers this configuration because it means more feet will be stressed. Although the (b) candidate's stressless feet produce two MapGM (Ft) violations, FG-Right prefers this configuration because it means fewer gridmarks.

Consider next the competing preferences of foot-gridmark alignment and foot-head alignment. The interaction is less obvious than the one above. In competitions between a candidate with non-intersected binary footing, such as (70a) below, and a candidate with intersected binary footing, such as (70b), foot-gridmark alignment will prefer the intersected candidate, and foot-head alignment, as we saw in detail above, will prefer the non-intersected

candidate. FG-Right illustrates the effects of foot-gridmark alignment, and Hds-Right illustrates the effects of foot-head alignment.

(70) FG-Right and Hds-Right

$\sigma\sigma\sigma\sigma\sigma$	FG-Right	Hds-Right
a. $\begin{array}{cccccc} & x & & x & & x \\ \sigma & \sigma & \sigma & \sigma & \sigma & \sigma \\ & \diagdown & & \diagdown & & \diagdown \end{array}$	** *****	** *****
b. $\begin{array}{cccccc} & x & & x & & \\ \sigma & \sigma & \sigma & \sigma & \sigma & \sigma \\ & \diagdown & \diagdown & \diagdown & \diagdown & \diagdown \end{array}$	* *****	* **** *****

In (70), both candidates are six-syllable prosodic words. Although the (a) candidate's non-intersected footing requires a foot-level gridmark for every two syllables and produces more FG-Right violations, Hds-Right prefers this footing because it means fewer foot-heads. Although the (b) candidate's intersected footing produces more feet and more Hds-Right violations, FG-Right prefers this footing because it allows gridmark sharing and only requires a foot-level gridmark for every three syllables.

In considering the three patterns and the three constraint types together, unbounded patterns emerge under the most general conditions, binary patterns emerge under slightly more specific conditions, and ternary patterns emerge under the most specific conditions. Regardless of the ranking of foot-head alignment, ranking foot-gridmark alignment over MapGM (Ft) will produce an unbounded pattern. Regardless of the relative ranking between foot-head alignment and MapGM (Ft), ranking both above foot-gridmark alignment will produce a binary pattern. Finally, the only ranking that will produce a ternary pattern is where MapGM (Ft) dominates foot-gridmark alignment and foot-gridmark alignment dominates foot-head alignment.

To illustrate, consider the interactions of FG-Right (representing foot-gridmark alignment), Hds-Right (representing foot-head alignment), and MapGM (Ft) in the next four tableaux. First, an unbounded pattern emerges whenever FG-Right ranks above

MapGM (Ft). Given this specific ranking, as (71) demonstrates, there is no crucial ranking between Hds-Right and MapGM (Ft), and as (72) demonstrates, there is no crucial ranking between Hds-Right and FG-Right.

(71) FG-Right >> MapGridmark, Hds-Right

σσσσσσ	FG-Right	MapGM (Ft)	Hds-Right
a. $\begin{array}{cccccc} & x & & x & & x \\ \sigma & \sigma & \sigma & \sigma & \sigma & \sigma \\ & \swarrow & & \swarrow & & \swarrow \end{array}$	*!* *****		** *****
b. $\begin{array}{cccccc} & & & & & x \\ \sigma & \sigma & \sigma & \sigma & \sigma & \sigma \\ & \swarrow & & \swarrow & & \swarrow \end{array}$		**	** *****
c. $\begin{array}{cccccc} & x & & & x & \\ \sigma & \sigma & \sigma & \sigma & \sigma & \sigma \\ & \swarrow & \swarrow & \swarrow & \swarrow & \swarrow \end{array}$	*!* *****		* *** *****

In (71), each candidate is a six-syllable prosodic word. The (a) candidate exhibits a binary pattern, the (b) candidate an unbounded pattern, and the (c) candidate a ternary pattern. The highest ranked constraint, FG-Right, screens out the multiple gridmarks of the binary candidate (a) and the ternary candidate (c), leaving the single gridmark of the unbounded candidate (b) as the winner. Since neither MapGM (Ft) nor Hds-Right have an effect on the outcome, there is no crucial ranking between them.

(72) FG-Right, Hds-Right >> MapGM (Ft)

σσσσσσ	FG-Right	Hds-Right	MapGM (Ft)
a. $\begin{array}{cccccc} & x & & x & & x \\ \sigma & \sigma & \sigma & \sigma & \sigma & \sigma \\ & \swarrow & & \swarrow & & \swarrow \end{array}$	*!* *****	** *****	
b. $\begin{array}{cccccc} & & & & & x \\ \sigma & \sigma & \sigma & \sigma & \sigma & \sigma \\ & \swarrow & & \swarrow & & \swarrow \end{array}$		** *****	**
c. $\begin{array}{cccccc} & x & & & x & \\ \sigma & \sigma & \sigma & \sigma & \sigma & \sigma \\ & \swarrow & \swarrow & \swarrow & \swarrow & \swarrow \end{array}$	*!* *****	* *** *****!	

The candidates in (72) are the same as those in (71). FG-Right and Hds-Right screen out the ternary candidate (c) and FG-Right screens out the binary candidate (a), leaving the unbounded candidate (b) as the winner. MapGM (Ft) does not have a chance to influence the outcome. The ranking between the FG-Right and Hds-Right is not crucial. If FG-Right ranks above Hds-Right, FG-Right screens out the multiple gridmarks of the binary and ternary candidates, as in (71) above, leaving the single gridmark of the unbounded pattern as the winner. If Hds-Right ranks above FG-Right, Hds-Right screens out the additional foot-heads of the ternary candidate (c), and passes (a) and (b) on to FG-Right. FG-Right screens out the multiple gridmarks of the binary candidate (a), leaving the single gridmark of the unbounded candidate (b) as the winner.

Second, a binary pattern emerges whenever FG-Right is the lowest ranked of the three constraints. As (73) demonstrates, the ranking between Hds-Right and MapGM (Ft) is not crucial, as long as both rank above FG-Right.

(73) Hds-Right, MapGM (Ft) >> FG-Right

	σσσσσ	Hds-Right	MapGM (Ft)	FG-Right
a.	$\begin{array}{cccccc} & & x & & x & & x \\ \sigma & \sigma & \sigma & \sigma & \sigma & \sigma & \sigma \\ & \swarrow & & \swarrow & & \swarrow & \end{array}$	** *****		** *****
b.	$\begin{array}{cccccc} & & & & & & x \\ \sigma & \sigma & \sigma & \sigma & \sigma & \sigma & \sigma \\ & \swarrow & & \swarrow & & \swarrow & \end{array}$	** *****	*!*	
c.	$\begin{array}{cccccc} & & x & & x & & \\ \sigma & \sigma & \sigma & \sigma & \sigma & \sigma & \sigma \\ & \swarrow & \swarrow & \swarrow & \swarrow & \swarrow & \end{array}$	* *****!*		* *****

In (73), the candidates are the same as in (71) and (72) above. Hds-Right screens out the additional foot-heads of the ternary candidate (a), and MapGM (Ft) screens out the stressless feet of the unbounded candidate (b). This leaves the binary candidate (a) as the winner, and FG-Right has no effect on the outcome. There is no crucial ranking between Hds-Right and MapGM (Ft). If Hds-Right ranks above MapGM (Ft), Hds-Right screens

out the additional foot-heads of the ternary candidate (b) and passes the decision between (a) and (b) on to MapGM (Ft). MapGM (Ft) screens out the stressless feet of the unbounded candidate (b), leaving the binary (a) as the winner. If MapGM (Ft) ranks above Hds-Right, MapGM (Ft) screens out the stressless feet of the unbounded candidate (b) and passes the decision between (a) and (c) on to Hds-Right. Hds-Right screens out the additional foot-heads of the ternary candidate (c), leaving the binary (a) as the winner.

Finally, a ternary pattern emerges only when MapGM (Ft) ranks over FG-Right and FG-Right ranks over Hds-Right:

(74) MapGM (Ft) >> FG-Right >> Hds-Right

$\sigma\sigma\sigma\sigma\sigma$	MapGM (Ft)	FG-Right	Hds-Right
a. $\begin{array}{cccccc} & x & & x & & x \\ \sigma & \sigma & \sigma & \sigma & \sigma & \sigma \\ & \diagdown & & \diagdown & & \diagdown \end{array}$		** *****!	** *****
b. $\begin{array}{cccccc} & & & & & x \\ \sigma & \sigma & \sigma & \sigma & \sigma & \sigma \\ & \diagdown & & \diagdown & & \diagdown \end{array}$	*!*		** *****
c. $\begin{array}{cccccc} & x & & x & & \\ \sigma & \sigma & \sigma & \sigma & \sigma & \sigma \\ & \diagdown & \diagdown & \diagdown & \diagdown & \diagdown \end{array}$		* *****	* *** *****

In (74), the candidates are the same as in (71-73). MapGM (Ft) screens out the stressless feet of the unbounded (b) candidate and passes the decision between (a) and (c) on to FG-Right. FG-Right screens out the additional gridmarks of the binary candidate (a), leaving the ternary candidate (c) as the winner. Given its low ranking, Hds-Right does not have a chance to influence the outcome.

Adding the foot-gridmark alignment constraints to the grammar, then, introduces crucial interactions to the constraint set. In particular, of six possible types of rankings, three produce unbounded patterns, two produce binary patterns, and one produces ternary patterns:

(75) Summary of Rankings

a. Unbounded Patterns

Foot-Gridmark Alignment >> MapGM (Ft) >> Foot-Head Alignment
Foot-Gridmark Alignment >> Foot-Head Alignment >> MapGM (Ft)
Foot-Head Alignment >> Foot-Gridmark Alignment >> MapGM (Ft)

b. Binary Patterns

MapGM (Ft) >> Foot-Head Alignment >> Foot-Gridmark Alignment
Foot-Head Alignment >> MapGM (Ft) >> Foot-Gridmark Alignment

c. Ternary Patterns

MapGM (Ft) >> Foot-Gridmark Alignment >> Foot-Head Alignment

We have already examined the core binary patterns above and will examine variations on these patterns in Chapters 4 and 5. Below, we will examine the core unbounded patterns and the ternary pattern of Chugach. We will explore variations on unbounded patterns also in Chapters 4 and 5. Before examining these patterns in more detail, however, it is necessary to examine foot-gridmark alignment's directionality effects.

3.3.2.1.2 Directionality

Given that foot-level gridmarks must correspond to foot-heads in the proposed account, it might seem that there would be significant directional interactions between foot-gridmark alignment and foot-head alignment in both binary and ternary patterns. This is not the case. Foot-gridmark alignment's directionality effects are limited to ternary and unbounded patterns, and foot-head alignment's directionality effects are limited to binary patterns. Foot-gridmark alignment cannot affect directionality in binary patterns (and so has no bearing on the directional effects in the analysis of minimal and maximal alternation presented above). If foot-gridmark alignment has enough influence in a particular ranking to affect directionality, then it also has enough influence to establish at least a ternary pattern (and, depending on the ranking of MapGM (Ft), possibly an unbounded pattern). Similarly, foot-head alignment cannot affect directionality in ternary patterns (and so has no bearing on the directional effects in the analysis of ternary patterns to be presented below). If foot-head

alignment has enough influence in a particular ranking to affect directionality, then it also has enough influence to establish a binary pattern.

To illustrate, (76) contrasts the preferences of FG-Right to the preferences of the foot-head alignment constraint with the opposite directional specification, Hds-Left.

(76) FG-Right and Hds-Left

$\sigma\sigma\sigma\sigma\sigma$	FG-Right	Hds-Left
a. $\begin{array}{ccccc} & x & & x & \\ \sigma & \sigma & \sigma & \sigma & \sigma & \sigma \\ & \diagdown & \diagup & \diagdown & \diagup \end{array}$	* **** (5)	* ** ***** (12)
b. $\begin{array}{ccccc} & x & & x & \\ \sigma & \sigma & \sigma & \sigma & \sigma & \sigma \\ & \diagup & \diagdown & \diagup & \diagdown \end{array}$	* **** (5)	* *** ***** (8)
c. $\begin{array}{ccccc} & x & & x & & x \\ \sigma & \sigma & \sigma & \sigma & \sigma & \sigma \\ & \diagdown & & \diagdown & & \diagdown \end{array}$	** ***** (6)	* *** ***** (9)
d. $\begin{array}{ccccc} & x & & x & & x \\ \sigma & \sigma & \sigma & \sigma & \sigma & \sigma \\ & \diagup & & \diagup & & \diagup \end{array}$	* *** ***** (9)	** ***** (4)

In (76), the (a) candidate is a ternary pattern with iambic footing, and the (b) candidate is a ternary pattern with trochaic footing. The (c) candidate is a binary pattern with iambic footing, and the (d) candidate is an binary pattern with trochaic footing. Although FG-Right does prefer the iambic binary candidate (c) over the trochaic binary candidate (d), it prefers the iambic ternary candidate (a) over both (c) and (d). Similarly, although Hds-Left does prefer the trochaic ternary candidate (b) over the iambic ternary candidate (a), it prefers the trochaic binary candidate (d) over both (a) and (b). If FG-Right ranks over Hds-Left, then the output will not only be an iambic form, it will be an iambic *ternary* form, and if Hds-Left ranks over FG-Right, then the output will not only be a trochaic form, it will be a *binary* trochaic form.

Next, (77) contrasts the preferences of FG-Left with those of the foot-head alignment constraint with the opposite directional specification, Hds-Right.

(77) FG-Left and Hds-Right

$\sigma\sigma\sigma\sigma\sigma$	FG-Left	Hds-Right
a. $\begin{array}{c} x \quad x \\ \sigma \ \sigma \ \sigma \ \sigma \ \sigma \\ \diagdown \ \diagup \ \diagdown \ \diagup \end{array}$	* **** (5)	* ** ***** (12)
b. $\begin{array}{c} x \quad x \\ \sigma \ \sigma \ \sigma \ \sigma \ \sigma \\ \diagup \ \diagdown \ \diagup \ \diagdown \end{array}$	* **** (5)	* *** ***** (8)
c. $\begin{array}{c} x \quad x \quad x \\ \sigma \ \sigma \ \sigma \ \sigma \ \sigma \\ \diagdown \ \diagdown \ \diagdown \end{array}$	** ***** (6)	* *** ***** (9)
d. $\begin{array}{c} x \quad x \quad x \\ \sigma \ \sigma \ \sigma \ \sigma \ \sigma \\ \diagup \ \diagup \ \diagup \end{array}$	* *** ***** (9)	** ***** (4)

In (77), the (a) candidate is a ternary pattern with trochaic footing, and the (b) candidate is a ternary pattern with iambic footing. The (c) candidate is a binary pattern with trochaic footing, and the (d) candidate is a binary pattern with iambic footing. Although FG-Left does prefer the trochaic binary candidate (c) over the iambic binary candidate (d), it prefers the trochaic ternary candidate (a) over both (c) and (d). Similarly, although Hds-Right does prefer the trochaic ternary candidate (a) over the iambic ternary candidate (b), it prefers the iambic binary candidate (d) over both (a) and (b). If FG-Left ranks over Hds-Right, then, the winning candidate will not only be trochaic, it will be trochaic and *ternary*, and if Hds-Right ranks over FG-Left the winning candidate will not only be iambic, it will be iambic and *binary*.

To summarize, given a ranking consistent with producing binary patterns, foot-gridmark alignment will have no effect on directionality, and, given a ranking consistent with producing ternary patterns, foot-head alignment will have no effect on directionality. Notice in the tableaux above, however, that iambic and trochaic ternary patterns are identical in $3n$ forms, so that foot-gridmark alignment constraints do not really decide between them. To get a better feel for the directionality effects of foot-gridmark alignment, some of which will be surprising, it is necessary to consider $3n + 1$ and $3n + 2$ forms, as we will in detail in the

examination of Chugach further below. At this point, it will be sufficient to show that FG-Right really does prefer iambic footing in ternary patterns and that FG-Left really does prefer trochaic footing in ternary patterns. This is demonstrated using a five-syllable form in (78).

(78) FG-Left and FG-Right

$\sigma\sigma\sigma\sigma\sigma$	FG-Left	FG-Right
a. $\overset{x}{\sigma} \ \overset{x}{\sigma} \ \sigma \ \sigma \ \sigma$ 	***	* ****
b. $\sigma \ \overset{x}{\sigma} \ \sigma \ \overset{x}{\sigma} \ \sigma$ 	* ****	***

In (78), the (a) candidate is parsed using one non-intersected and two intersected trochaic feet, and the (b) candidate is parsed using one non-intersected and two intersected iambic feet. Since the gridmarks in the trochaic candidate (a) are closer to the left edge than those in the iambic candidate (b), FG-Left prefers candidate (a). Since the gridmarks in the iambic candidate (b) are closer to the right edge than those in the trochaic candidate (a), FG-Right prefers candidate (b).

3.3.2.2 Unbounded Stress Systems: Tinrin and Uzbek

The proposal's insistence on exhaustively parsing syllables into feet that are no larger than disyllabic has left it with limited options for analyzing unbounded stress systems, systems in which there is only a single stress for each form. Although these systems occur in both weight-sensitive and weight-insensitive varieties, I will discuss only the weight-insensitive type at this point and wait to examine the weight-sensitive type until Chapter 5.

In weight-insensitive unbounded systems, a single stress occurs typically² either at the left edge of the form, as in Tinrin (Osumi 1995; see also Walker 1996), or at the right edge of the form, as in Uzbek (Poppe 1962, Walker 1996):

(79) Tinrin Forms (from Osumi 1995)³

HL	hú:e	<i>white</i>
LL	áũ	<i>fog</i>
LLL	véua	<i>whetstone</i>
LHL	húsa:u	<i>sometimes</i>
HLL	ó:juo	<i>chair</i>
LLL	şúvehaçu	<i>to like</i>

(80) Uzbek Forms (from Walker 1996)

H́L	aitdí	<i>he said</i>
LH́	kitób	<i>book</i>
LLH́	kitobím	<i>my book</i>
HLH́	aŋlamóq	<i>to understand</i>
HLLH́	aŋladilár	<i>they understood</i>

As (79) illustrates, regardless of the form's length or the weight of the syllables involved, stress in Tinrin always occurs on the initial syllable. As (80) illustrates, regardless of the form's length or the weight of the syllables involved, stress in Uzbek always occurs on the final syllable.

The difficulty that such languages present for the proposed account is how to limit forms to a single stress when they are long enough to have multiple feet. Due to Strict Succession, the possibility of creating a single foot and leaving the remaining syllables unfooted, as in (81a, b), is unavailable.

² There are also quantity insensitive unbounded systems that have stress on the penultimate syllable. This possibility will be discussed in Chapter 4.

³ The position of stress for /húsa:u/ and /şúvehaçu/ was not indicated in Osumi 1995 but can be inferred from Osumi's description.

(81) Unavailable Options: Non-Parsing and Unbounded Feet

Single Binary Foot

a. Stress Leftmost

b. Stress Rightmost

$\overset{x}{(\sigma \ \sigma)} \ \sigma \ \sigma \ \sigma \ \sigma$ $\sigma \ \sigma \ \sigma \ \sigma \ (\sigma \ \overset{x}{\sigma})$

Unbounded Foot

c. Stress Leftmost

d. Stress Rightmost

$\overset{x}{(\sigma \ \sigma \ \sigma \ \sigma \ \sigma \ \sigma)}$ $(\sigma \ \sigma \ \sigma \ \sigma \ \sigma \ \overset{x}{\sigma})$

Similarly, due to the FootCap Condition, the option of parsing every syllable into a single unbounded foot, as in (81c, d), is also unavailable.

Having made violable in the proposed account the relationship between feet and stress, however, another option presents itself— that of footing every syllable in a form and stressing only a single foot,⁴ as in (82):

(82) Another Option: Stressless Feet

a. Stress Leftmost

b. Stress Rightmost

$\overset{x}{\sigma} \ \sigma \ \sigma \ \sigma \ \sigma \ \sigma$ $\sigma \ \sigma \ \sigma \ \sigma \ \sigma \ \overset{x}{\sigma}$
 $\swarrow \quad \swarrow \quad \swarrow$ $\swarrow \quad \swarrow \quad \swarrow$

With the addition to the proposal of the constraints in (64), the grammar is able to obtain the types of structures in (82) by ranking the appropriate foot-gridmark alignment constraint over MapGM (Ft). As demonstrated in (71) and (72) above, this allows the preference of foot-gridmark alignment for a minimal amount of structure to take precedence over the foot-stress relationship.

It is important, however, not to give foot-gridmark alignment constraints too much preference. Since vacuous satisfaction is possible, as (83) demonstrates, ranking both FG-Left and FG-Right above MapGM (Ft) would produce a pattern with total absence of stress, rather than an unbounded pattern.

⁴ This type of analysis has a precedent in Crowhurst's (1996) analysis of Cairene Arabic. The mechanisms for obtaining stressless feet in the proposed approach, however, are different than those presented in Crowhurst's account.

(83) FG-Left, FG-Right >> MapGM (Ft)

	σσσσσσ	FG-Left	FG-Right	MapGM (Ft)
☞ a.	σ σ σ σ σ σ ∨ ∨ ∨			***
b.	^x σ σ σ σ σ σ ∨ ∨ ∨		*!*****	**
b.	σ σ σ σ σ ^x σ ∨ ∨ ∨	*!*****		**

In (83) each of the candidates are six-syllable prosodic words. The (a) candidate has no gridmarks; the (b) candidate has a single foot-level gridmark at its left edge; and the (c) candidate has a single foot-level gridmark at its right edge. FG-Left screens out the right-oriented candidate (c), and FG-Right screens out the left-oriented candidate (b). This leaves the stressless candidate (a) as the winner. For an unbounded pattern to emerge, then, MapGM (Ft) must intervene between the two foot-gridmark alignment constraints.

The left-oriented Tinrin pattern emerges under the ranking FG-Left >> MapGM (Ft) >> FG-Right. As (84) demonstrates using /ʃúúvehaɾu/, ranking FG-Left over MapGM (Ft) ensures that there will be at most a single foot-level gridmark and that this gridmark will occur at the left edge of the prosodic word. Ranking MapGM (Ft) over FG-Right prevents vacuous satisfaction of both alignment constraints and the resulting stressless output form.

(84) FG-Left >> MapGM (Ft) >> FG-Right

şuveharu	FG-Left	MapGM (Ft)	FG-Right
^x a. şu ve ha ru / /		*	***
b. şu ve ha ru / /		*!*	
^x c. şu ve ha ru \ \	*!***	*	
^x ^x d. şu ve ha ru / /	*!*		* ****

In (84), each of the candidates is a four-syllable prosodic word with two feet. The (a) candidate has a single foot-level gridmark at the left edge of the prosodic word; the (b) candidate has no gridmarks; the (c) candidate has a single gridmark at the right edge of the prosodic word; and the (d) candidate has two gridmarks, one for each foot. FG-Left screens out the right-oriented gridmark of the unbounded candidate (c) and the multiple gridmarks of the binary candidate (d) and passes the decision between (a) and (b) on to MapGM (Ft). MapGM (Ft) screens out the vacuous candidate (b) and leaves the single left-oriented gridmark of the unbounded candidate (a) as the winner. Given its low ranking, FG-Right does not have a chance to influence the outcome.

The right-oriented Uzbek pattern emerges simply by switching the positions of the two alignment constraints from the ranking in (84) so that it becomes FG-Right >> MapGM (Ft) >> FG-Left. As (85) demonstrates using [aŋladilár], ranking FG-Right over MapGM (Ft) ensures that there will be at most a single foot-level gridmark and that this gridmark will occur at the right edge of the prosodic word. Ranking MapGM (Ft) over FG-

Left prevents vacuous satisfaction of the two alignment constraints and the resulting stressless output form.

(85) FG-Right >> MapGM (Ft) >> FG-Left

anladilar	FG-Right	MapGM (Ft)	FG-Left
a. aŋ la di lar ^x 		*	***
b. aŋ la di lar 		*!*	
c. aŋ ^x la di lar 	*!***	*	
c. aŋ ^x la ^x di lar 	*!*		* ****

In (85), each candidate is a four-syllable prosodic word with two feet. Candidate (a) has a single foot-level gridmark at the right edge of the prosodic word; candidate (b) has no foot-level gridmarks; candidate (c) has a single foot-level gridmark at the left edge of the prosodic word; and candidate (d) has one gridmark for each foot in the form. FG-Right screens out the left-oriented gridmark of the unbounded candidate (c) and the multiple gridmarks of the binary candidate (d) and passes the decision between (a) and (b) on to MapGM (Ft). MapGM (Ft) screens out the vacuous candidate (b) and leaves the single right-oriented gridmark of the unbounded candidate (a) as the winner. Given its low ranking, FG-Left cannot influence the outcome.

We have seen, then, that despite the exhaustive parsing imposed by Strict Succession and the maximally disyllabic foot size imposed by FootCap, the proposed account is able to obtain the patterns of weight-insensitive unbounded stress systems. This is accomplished because the preference of foot-gridmark alignment for a minimal amount of struc-

ture is in conflict with the foot-stress relationship. When a foot-gridmark alignment constraint ranks over MapGM (Ft), the conflict is resolved in favor of the former, and an unbounded stress pattern emerges.

3.3.2.3 A Ternary Pattern: Chugach

Obtaining ternary patterns from binary footing is a general difficulty and not limited to the approach proposed here. The proposed account's inflexibility with respect to exhaustive parsing and maximal binarity, however, make the difficulty especially acute. The options of weak local parsing (see, for example, Hayes 1995 and Kager 1994) and ternary feet (see, for example, Halle and Vergnaud 1987) are not possible here, but the proposed account itself has devices— gridmark sharing and the toleration of improper bracketing— that were unavailable in earlier accounts. These devices allow the proposal to obtain ternary alternations without sacrificing either exhaustive parsing or maximal binarity.

When two disyllabic intersecting feet share a gridmark, they mimic the pattern of an amphibrach, a stressless syllable occurring on either side of the stressed syllable:

(86) Intersections and Amphibrachs

a. Intersecting Configuration

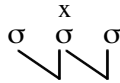

b. Amphibrach

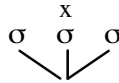

By repeating such intersecting structures across a form, the proposed account is able to obtain the same types of ternary patterns that would be susceptible to analysis in terms of amphibrachs.

One such pattern is that of Chugach⁵ (Leer 1985a, b, c; see also Rice 1988, 1990, Halle 1990, Kager 1993, and Hayes 1995). Although the influence of syllable weight produces substantial effects on its basic ternary alternation, I will set this factor aside and focus on forms with only light syllables:

⁵ Rice 1988, 1990, and Halle 1990 analyze Chugach in terms of amphibrachs.

(87) Chugach Forms (from Leer 1985a)

σ́σ	atáka	<i>my father</i>
σ́σσ	akútamék	<i>(kind of food) (abl. sg.)</i>
σ́σσσ	atúquníkí	<i>if he (refl.) uses them</i>
σ́σσσσ	pisúqutaqúni	<i>if he (refl.) is going to hunt</i>
σ́σσσσσ	mangársuqutáquní	<i>if he (refl.) is going to hunt porpoise</i>

In Chugach, as (87) illustrates, the leftmost stress occurs on the second syllable. Stress then occurs on every subsequent third syllable, given sufficient length. If there are two syllables remaining after ternary alternation is no longer possible, the second is stressed. If there is only one syllable remaining, it is unstressed.

The key in the proposed account to obtaining the Chugach pattern is to reduce the number of gridmark entries from one for every two syllables to one for every three syllables by multiplying the number of feet. The primary obstacle is the preference of foot-head alignment for a minimal number of feet— the preference that was responsible for promoting non-intersecting binary footing in the analysis of minimal and maximal alternation patterns above. Overcoming this obstacle involves the two crucial rankings of (75c): MapGM (Ft) >> foot-gridmark alignment and foot-gridmark alignment >> foot-head alignment. First, foot-gridmark alignment must rank over foot-head alignment so that it is more important to have a minimal number of gridmark entries than it is to have a minimal number of foot-heads, and, second, MapGM (Ft) must rank over both types of alignment so that unbounded patterns are not possible and a conflict between the two alignment types actually arises. As the number of feet multiplies, they intersect and are able to share gridmark entries, meaning that a gridmark occurs for every three syllables rather than for every two. The examples in (88) illustrate the types of structures that will be posited to account for the Chugach pattern.

(88) Proposed Structures

a. $3n$ Forms

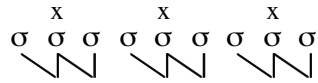
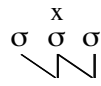

b. $3n + 1$ Forms

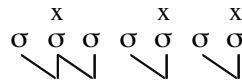
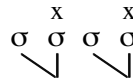

c. $3n + 2$ Forms

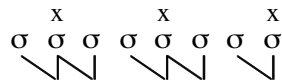

As (88) illustrates, $3n + 2$ forms have a single non-intersected binary foot that follows one or more intersecting configurations, given sufficient length; $3n + 1$ forms have two non-intersecting binary feet that follow one or more intersecting configurations, given sufficient length; and $3n$ forms contain only intersecting configurations.

For Chugach, the relevant foot-gridmark alignment constraint is FG-Right— to ensure that the footing is iambic rather than trochaic. Although FG-Right must rank over both foot-head alignment constraints, I will use only Hds-Right to illustrate the effects of foot-

head alignment in the tableaux that follow. This gives the ranking MapGM (Ft) >> FG-Right >> Hds-Right. The effects of this ranking are most easily demonstrated with $3n$ forms, where each syllable can be included in an intersecting configuration and the question of what to do with leftover syllables does not arise. Consider, for example, the six-syllable /pisúqutaqúni/ in (89):

(89) $3n$ Form: MapGM (Ft) >> FG-Right >> Hds-Right

pisuqutaquni	MapGM	FG-Right	Hds-Right
a. $\begin{array}{cccccc} & x & & x & & \\ & \pi & s & u & q & u & t & a & q & u & n & i \\ & \swarrow & \searrow & \swarrow & \searrow & \swarrow & \searrow & \swarrow & \searrow & \swarrow & \searrow & \swarrow & \searrow \end{array}$		* **** (5)	* *** **** (8)
b. $\begin{array}{cccccc} & x & & x & & x & & \\ & \pi & s & u & q & u & t & a & q & u & n & i \\ & \swarrow & \searrow & \swarrow & \searrow & \swarrow & \searrow & \swarrow & \searrow & \swarrow & \searrow & \swarrow & \searrow \end{array}$		** *****! (6)	** **** (6)
c. $\begin{array}{cccccc} & & & & & x & & \\ & \pi & s & u & q & u & t & a & q & u & n & i \\ & \swarrow & \searrow & \swarrow & \searrow & \swarrow & \searrow & \swarrow & \searrow & \swarrow & \searrow & \swarrow & \searrow \end{array}$	*!*		** **** (6)

In (89), the (a) candidate is parsed by two intersecting configurations— four feet and four foot-heads— with a foot-level gridmark occurring in each intersection. The (b) and (c) candidates are both parsed by three non-intersecting feet. The difference between them is that each foot in the (b) candidate corresponds to a foot-level gridmark where only the final foot in the (c) candidate corresponds to a foot-level gridmark. MapGM (Ft) screens out the stressless feet of the unbounded candidate (c) and passes the decision between (a) and (b) on to FG-Right. FG-Right screens out the additional gridmarks of the binary candidate (b), leaving the ternary candidate (a) as the winner. Given its low ranking Hds-Right does not have a chance to influence the outcome.

Unlike $3n$ forms, $3n + 1$ and $3n + 2$ forms cannot be exhaustively parsed into intersecting configurations. In examining what happens to the leftover syllables, we will see a familiar situation where foot-head alignment eliminates unnecessary intersections. We will

also see a new directionality phenomenon where foot-gridmark alignment prefers intersections to occur opposite the designated edge.

As $3n + 2$ forms always have two syllables that cannot be included in an intersecting configuration, these leftover syllables will form a separate single non-intersected foot. The question here is where among the intersections this single foot will occur. As demonstrated in the discussion of minimal and maximal alternation above, the preference of foot-head alignment is for intersections to occur near the designated edge and for non-intersected feet to occur away from the designated edge. This allows the concentrations of foot-heads that accompany intersections to incur fewer alignment violations. With foot-gridmark alignment, however, the objects being aligned occur in greater concentrations in non-intersected feet than they do in intersected feet, so that this type of alignment has just the opposite effect. Foot-gridmark prefers intersections to occur away from the designated edge and non-intersected feet to occur near the designated edge. This is demonstrated using the five-syllable form /atúquniki/ in (90). Only candidates which conform to MapGM (Ft) are considered:

(90) $3n + 2$ Form: MapGM (Ft) >> FG-Right >> Hds-Right

atuquniki	MapGM (Ft)	FG-Right	Hds-Right
a. $\begin{array}{cccccc} & & x & & & x \\ & & \downarrow & \downarrow & & \downarrow \\ a & tu & qu & ni & ki \end{array}$		***	** ***
b. $\begin{array}{cccccc} & & x & & & x \\ & & \downarrow & \downarrow & \downarrow & \downarrow \\ a & tu & qu & ni & ki \end{array}$		* ***!	* ***

In (90), both of the candidates are parsed using one intersecting configuration and one non-intersected foot. In candidate (a), the non-intersected foot occurs at the right edge of the prosodic word, but in candidate (b), the non-intersected foot occurs at the left edge of the prosodic word. Although MapGM (Ft) would have the effect of screening out additional

unbounded candidates, given the limited comparison here, it has no influence on the evaluation. FG-Right screens out the right-oriented foot-heads of candidate (b), and leaves the right-oriented gridmarks of candidate (a) as the winner. Given its low ranking, Hds-Right cannot affect the outcome.

This same phenomenon occurs in $3n + 1$ forms. Non-intersected feet occur near the designated edge, and intersected feet occur away from the designated edge. The situation of most interest with this type, however, is that more intersecting configurations are possible than actually occur. Rather than having as many intersections as possible with a monosyllabic foot leftover, these forms have two non-intersected binary feet with the remaining syllables being parsed into intersections. Although both options would produce identical gridmark patterns, as (91) demonstrates for the seven-syllable /mangársuqutáquní/, the grammar prefers the latter option over the former because it has fewer feet and fewer violations of Hds-Right. (Only candidates that satisfy MapGM (Ft) are considered.)

(91) $3n + 1$ Form: MapGM (Ft) >> FG-Right >> Hds-Right

mangarsuqutaquni	MapGM (Ft)	FG-Right	Hds-Right
		** ***** (7)	** ***** ***** (11)
		** ***** (7)	* ** ***** *****! (12)
		* *** *****! (9)	* *** ***** (9)

In (91), the (a) candidate has an intersection at the left edge preceding two non-intersected binary feet; the (b) candidate has two intersections preceding a monosyllabic foot; and the (c) candidate has two non-intersected binary feet preceding an intersection at the right edge. Although MapGM (Ft) would screen out additional unbounded candidates, given the limited

comparison here, it has no effect on the evaluation. FG-Right screens out the right-oriented foot-heads of candidate (c) and passes the decision between the right-oriented gridmarks of (a) and (b) on to Hds-Right. Hds-Right screens out the additional foot-heads of candidate (b) and leaves (a) as the winner.

The toleration of improper bracketing and gridmark sharing, then, allow the proposal to obtain ternary patterns in addition to binary and unbounded patterns without sacrificing either exhaustive parsing or maximal binarity. Gridmark alignment is the key to obtaining this result. With gridmark alignment ranked between MapGM (Ft) and foot-head alignment, the pressure for a minimal number of gridmarks is sufficient to promote improper bracketing and gridmark sharing, but it is not sufficient to promote stressless feet.

3.3.3 Restrictions on Gridmark Alignment

Now that we have seen some of the ways in which the proposal puts gridmark alignment constraints to use, it is necessary also to mention the ways in which the proposal must restrict alignment in referring to gridmarks. The first restriction to be proposed, however, has the potential to apply to more than just gridmark entries:

(92) Restriction on Existential Quantification

No optional category may be existentially quantified in an alignment constraint. In the proposed account, gridmarks (with the exception of those corresponding to head moras) are optional categories, since the constraints requiring them to be present in a form are violable. Elements of the prosodic hierarchy and prosodic heads are non-optional categories, since the conditions requiring them to be present are non-violable.

The restriction in (92) is intended to prevent alignment constraints from requiring the presence of elements that are not already required by some non-violable part of the grammar. For gridmarks in particular, such a restriction is crucial in order to maintain important asymmetrical effects at left and right edges. Suppose, for example, that the theory

allowed the following pair of constraints, constraints which reverse the reference to foot-level gridmarks and prosodic words from the constraints of (64) above:

(93) Problematic Constraints

Align (PrWd, L, Ft-GM, L): the left edge of every prosodic word is aligned with the left edge of some foot-level gridmark.

Align (PrWd, R, Ft-GM, R): the right edge of every prosodic word is aligned with the right edge of some foot-level gridmark.

These constraints would only be satisfied when a foot-level gridmark occurs at one edge or the other of a prosodic word:

(94) Problematic Requirements

a. Align (PrWd, L, Ft-GM, L)

$\overset{x}{\sigma}$ σ σ σ σ σ

b. Align (PrWd, R, Ft-GM, R):

σ σ σ σ σ $\overset{x}{\sigma}$

As (94a) illustrates, a gridmark must occur at the left edge of the prosodic word in the case of Align (PrWd, L, Ft-GM, L), and as (94b) illustrates, a gridmark must occur at the right edge in the case of Align (PrWd, R, Ft-GM, R).

Notice that the configuration that Align (PrWd, L, Ft-GM, L) would demand is the same as that required by the Initial Gridmark constraint, introduced in Chapter 1 and to be discussed in a more generalized form Chapter 4:

(95) Initial Gridmark

A foot-level gridmark occurs over the initial syllable.

This situation in itself is not problematic. The problem arises because the configuration that Align (PrWd, R, Ft-GM, R) would demand is the same as the one that would be required by a Final Gridmark constraint, a constraint that was determined in Chapter 1 to be crucially absent from the grammar.

In particular, Align (PrWd, R, Ft-GM, R) would introduce to the theory the possibility of a clash configuration at the right edge of odd-parity forms and an option for clash resolution which involves leaving the penultimate syllable, rather than the ultima, stressless. To illustrate, ranking both MapGM (Ft) and Align (PrWd, R, Ft-GM, R) above *Clash in

systems with rightward foot-head alignment would produce a clash configuration at the right edge in odd-parity forms, allowing the grammar to obtain the unattested iambic double downbeat pattern:

(96) Iambic Double Downbeat Pattern

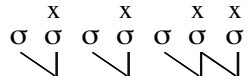

Ranking *Clash and Align (PrWd, R, Ft-GM, R) above MapGM (Ft) in systems with rightward foot-head alignment would produce a configuration with final stress rather than penultimate stress in odd-parity forms, allowing the grammar to obtain the unattested iambic edge ternary pattern:

(97) Iambic Edge Ternary Pattern

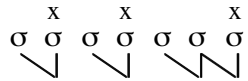

It is precisely because of alignment's right-left symmetry that the theory must avoid these constraints as a means for obtaining double downbeat and edge ternary patterns. Both patterns are asymmetrically attested and seem to require an asymmetrical constraint to obtain the correct results. It is not enough, however, that an asymmetrical means be available, it is also necessary that symmetrical means be absent.

The second and third restrictions on alignment's reference to gridmarks are specific to interactions between the metrical grid and other systems of the grammar. These are given in (98) and (99) below.

(98) Metrical Grid-Prosodic Prominence Interaction

There are no alignment relationships between the metrical grid and the system of prosodic prominence.

(99) Metrical Grid-Prosodic Hierarchy Interaction

Only gridmark entries below the prosodic word level have alignment relationships with categories of the prosodic hierarchy.

The restriction in (98) is mostly for the sake of simplicity. As there seems to be no need for alignment constraints between gridmark entries and prosodic heads, I will assume that such constraints are absent from the grammar. The restriction in (99), however, is necessary for reasons similar to those presented for (92).

Suppose, for example, that the grammar allowed the following two constraints aligning prosodic word-level gridmarks with the edges of prosodic words as a device for influencing the position of main stress.

(100) Alignment of Main Stress

Align (PrWd-GM, L, PrWd, L): the left edge of every prosodic word-level grid mark is aligned with the left edge of some prosodic word.

Align (PrWd-GM, R, PrWd, R): the right edge of every prosodic word-level grid-mark is aligned with the right edge of some prosodic word.

These constraints might be vacuously satisfied by the absence of a prosodic word-level gridmark, or they might be satisfied by the following two configurations, if MapGM (PrWd) is ranked sufficiently high:

(101) Satisfaction of Main Stress Alignment

a. Align (PrWd-GM, L)

$$\begin{array}{ccccccc} & & & & & & x \\ & & & & & & x \\ x & & & & & & \\ \sigma & \sigma & \sigma & \sigma & \sigma & \sigma & \end{array}$$

b. Align (PrWd-GM, R):

$$\begin{array}{ccccccc} & & & & & & x \\ & & & & & & x \\ & & & & & & \\ \sigma & \sigma & \sigma & \sigma & \sigma & \sigma & \end{array}$$

As (101) illustrates, Align (PrWd-GM, L, PrWd, L) would demand that a prosodic word-level gridmark, along with a supporting foot-level gridmark, occur at the left edge of the prosodic word, and Align (PrWd-GM, R, PrWd, R) would demand that a prosodic word-level gridmark, along with a supporting foot-level gridmark, occur at the right edge of the prosodic word.

The problem with this type of constraint, as with that in (93), is specifically due to the rightward version's ability to mimic a Final Gridmark constraint. In odd-parity forms with rightward foot-head alignment, Align (PrWd-GM, R, PrWd, R) creates a potential

clash configuration at the right edge. If both MapGM (Ft) and Align (PrWd-GM, R, PrWd, R) rank above *Clash in such systems, the result will be an iambic double downbeat pattern:

(102) Iambic Double Downbeat Pattern

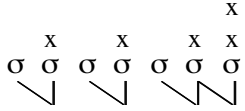

If both *Clash and Align (PrWd-GM, R, PrWd, R) rank above MapGM (Ft), the result will be an iambic edge ternary pattern:

(103) Iambic Edge Ternary Pattern

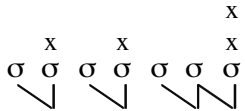

For these reasons, the proposed account does not align primary stress directly but positions it indirectly by aligning the head foot of prosodic words, as demonstrated in Section 3.2 above.

3.4 Summary

In this chapter, we have explored some of the uses for alignment constraints in the proposed account. The particular alignment constraints examined were those repeated in (104).

(104) Alignment Constraints

Foot-Head Alignment

Hds-Left or Align (Ft-Hd, L, PrWd, L): the left edge of every foot-head is aligned with the left edge of some prosodic word.

Hds-Right or Align (Ft-Hd, R, PrWd, R): the right edge of every foot-head is aligned with the right edge of some prosodic word.

Prosodic Word Alignment

PrWd-L or Align (PrWd, L, Ft-Hd, L): the left edge of every prosodic word is aligned with the left edge of some foot-head.

PrWd-R or Align (PrWd, R, Ft-Hd, R): the right edge of every prosodic word is aligned with the right edge of some foot-head.

Prosodic Word-Head Alignment

Hd-Left or Align (PrWd-Hd, L, PrWd, L): the left edge of every prosodic word-head is aligned with the left edge of some prosodic word.

Hd-Right or Align (PrWd-Hd, R, PrWd, R): the right edge of every prosodic word-head is aligned with the right edge of some prosodic word.

Mora-Level Gridmark Alignment

MG-Left or Align (Ft-GM, L, PrWd, L): the left edge of every mora-level gridmark is aligned with the left edge of some prosodic word.

MG-Right or Align (Ft-GM, R, PrWd, R): the right edge of every mora-level gridmark is aligned with the right edge of some prosodic word.

Foot-Level Gridmark Alignment

FG-Left or Align (Ft-GM, L, PrWd, L): the left edge of every foot-level gridmark is aligned with the left edge of some prosodic word.

FG-Right or Align (Ft-GM, R, PrWd, R): the right edge of every foot-level gridmark is aligned with the right edge of some prosodic word.

Hds-Left and Hds-Right preferred a minimal number of foot-heads and were responsible for establishing the non-intersected binary footing of binary alternation patterns. They also established the default connection between foot-type and footing directionality in minimal alternation patterns in particular. PrWd-L and PrWd-Right were introduced to disrupt the default connection established by foot-head alignment constraints. Together with the Lapse condition, these constraints were responsible for the conflicting directionality exhibited by minimal alternation patterns. Hd-Left and Hd-Right were the mechanisms for the determin-

ing the position of primary stress. MG-Left and MG-Right introduced the possibility of monopositionally mapping heavy syllables, and, finally, FG-Left and FG-Right enabled the proposal to produce unbounded and ternary patterns in addition to binary patterns. Several additional uses for these constraints will be examined in the following chapters.

We also saw that the theory must place certain limitations on alignment constraints in order to maintain its restrictiveness. Some of these restrictions, such as Strict Succession, FootCap, the Lapse Condition, and the Head Mora Condition were indirect, but it was also necessary to place more direct restrictions on the categories that alignment can refer to.

CHAPTER FOUR

ASYMMETRICAL CONSTRAINTS

In Chapter 1, I argued that the proposal must restrict the influence that symmetrical constraints such as alignment have in determining stress patterns. I also argued that asymmetrical constraints such as Initial Gridmark and NonFinality must play a larger role. In Chapter 3, we examined in greater detail the role of alignment in the proposed account, and, in this chapter, we will examine in greater detail the emergence of NonFinality and Initial Gridmark. We will also examine an additional set of alignment constraints, the Window constraints.

I have grouped NonFinality, Initial Gridmark, and Window constraints together in this chapter because they operate on similar principles and will be defined in terms of the same formal system. Initial Gridmark constraints require the greatest possible distance between the right edge of some domain and some appropriate gridmark. For example, an Initial gridmark constraint might demand, as in (1), that some foot-level gridmark occur on the syllable furthest from the right edge of a prosodic word.

- (1) Initial Gridmark: Greatest Possible Distance from Right Edge

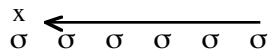

NonFinality constraints establish a minimal distance that must intervene between appropriate gridmarks and the right edge of some domain. For example, a NonFinality constraint might insist, as in (2), that at least one syllable intervene between a foot-level gridmark and the right edge of a prosodic word.

- (2) NonFinality: Minimum Distance from Right Edge

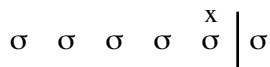

Window constraints establish the maximal distance that may intervene between appropriate gridmarks and either edge of some domain. For example, a Window constraint might require, as in (3), that no more than two syllables intervene between a prosodic word-level

gridmark and the left edge of a prosodic word or between a prosodic word-level gridmark and the right edge of a prosodic word.

(3) Window: Maximum Distance from Either Edge

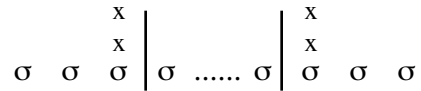

The common factor involved in Initial Gridmark, NonFinality, and Window constraints, then, is the regulation of distances between gridmarks and domain edges.

The proposal formalizes this principle by adding the Slope Category System to the grammar, a system which provides special designations for prosodic categories occurring between appropriate gridmarks and the edges of prosodic domains. By manipulating the number of these specially designated prosodic categories, Initial Gridmark, NonFinality, and Window constraints regulate the distances that occur between gridmarks and domain edges.

4.1 The Slope Category System

The Slope Category System is defined in reference to two systems discussed in Chapter 2, the metrical grid and the prosodic hierarchy. Slope Categories are those instances of prosodic categories which occur between a particular gridmark and the edges of some prosodic domain. For example, the configuration below shows a seven-syllable prosodic word with a foot-level gridmark over the fourth:

(4) Slope Categories

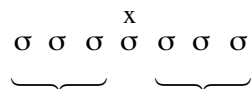

Each of the syllables preceding the gridmark, syllables one, two, and three, would be slope categories for the gridmark within the prosodic word, as would each of those syllables following the gridmark, syllables five, six, and seven. The fourth syllable is not a slope category for the gridmark because it occurs directly beneath it. It is not in between the gridmark and one of the edges of the prosodic word.

Slope categories occur in two types. Ascent categories are those instances of prosodic categories which occur between a gridmark and the left edge of some prosodic domain, and descent categories are those instances of prosodic categories which occur between a gridmark and the right edge of some prosodic domain:

(5) Ascent Categories and Descent Categories

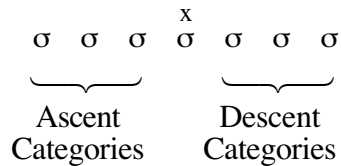

In (5), syllables one, two, and three would be ascent categories for the indicated gridmark within the domain of the prosodic word, and syllables five, six, and seven would be descent categories for the indicated gridmark within the domain of the prosodic word. The fourth syllable is neither an ascent category nor a descent category, since it occurs neither between the gridmark and the left edge of the domain nor between the gridmark and the right edge of the domain.

Although the above characterization is adequate as a general description of the system, the proposal will restrict the types of prosodic categories eligible to be slope categories relative to both the type of gridmark and the prosodic domain involved. The eligibility restriction is as follows:

(6) Eligibility Restriction

PCat1 is eligible to be a slope category of a PCat2-level gridmark in the domain of PCat3, if PCat1 < PCat2 and PCat1 < PCat3 in the prosodic hierarchy.

In other words, any prosodic category which is lower in the prosodic hierarchy than both the category which defines the domain and the category which corresponds to the relevant gridmark level is eligible to be a slope category for that gridmark in that domain. Any category that does not meet this restriction is ineligible. The following table summarizes the effects of the restriction:

(7) Effects of the Eligibility Restriction

<u>Gridmark Level</u>	<u>Domain</u>	<u>Eligible Categories</u>
Prosodic Word	Prosodic Word Foot Syllable	Foot, Syllable, Mora Syllable, Mora Mora
Foot	Prosodic Word Foot Syllable	Syllable, Mora Syllable, Mora Mora

For a prosodic word level-gridmark in the domain of a prosodic word, for example, feet, syllables, and moras are all eligible to be slope categories, because they are each lower in the prosodic hierarchy than prosodic words. For a foot-level gridmark in the same domain, however, only syllables and moras are eligible to be slope categories because only syllables and moras are lower in the hierarchy than both prosodic words and feet.

Given the eligibility restriction, the following is a more precise definition of ascent categories and descent categories:

(8) Slope Category Definitions

Ascent Category: Every eligible PCat1 that precedes some PCat2-level gridmark in the domain of PCat3 is an ascent category for that gridmark in that domain.

Descent Category: Every eligible PCat1 that follows some PCat2-level gridmark in the domain of PCat3 is a descent category for that gridmark in that domain.

The formulations in (8) are not constraints. The designation of appropriate prosodic categories as either ascent categories or descent categories is automatic and universal. The designation is neither optional nor dependent on any particular ranking of the constraint set.

Note that the definitions in (8) assign slope category status in terms of particular gridmarks and particular domains. As (9) illustrates, just because a certain prosodic category is an ascent category or a descent category for one gridmark in a certain domain does not mean that it is also an ascent category or descent category for another gridmark in that same domain, and, as (10) illustrates, just because a gridmark has ascent categories or descent categories in one domain does not mean that it has ascent categories or descent categories in another domain:

(9) Two Gridmarks in a Single Domain

a. First Gridmark

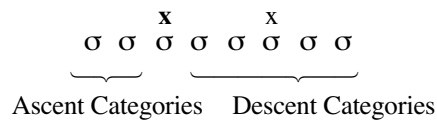

b. Second Gridmark

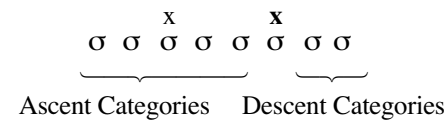

(10) Two Gridmarks in Different Domains

a. First Gridmark

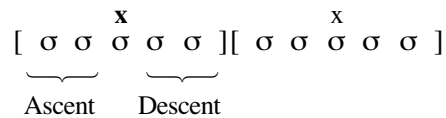

b. Second Gridmark

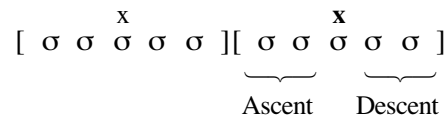

In (9), the examples each consist of an eight-syllable prosodic word with gridmarks over the third and sixth syllables. As (9a) indicates, only syllables one and two are ascent categories for the first gridmark, and it has syllables four through eight as its descent categories. As (9b) indicates, syllables one through five are ascent categories for the second gridmark, and it has only syllables seven and eight as its descent categories. In (10), the examples each consist of two five-syllable prosodic words, each of which has a gridmark over its third syllable. As (10a) indicates, only the first and second syllables of the first prosodic word are ascent categories for the first gridmark, and it has only the fifth and sixth syllables of the first prosodic word as its descent categories. As (10b) indicates, only the first and second syllables of the second prosodic word are ascent categories for the second gridmark, and it has only the fifth and sixth syllables of the second prosodic word as its descent categories.

The discussion that follows examines in detail the three types of constraints formulated in terms of the Slope Category System. The first two, NonFinality constraints and Initial Gridmark constraints, will be central in analyzing the asymmetrical part of the typology from Chapter 1, as well as additional iambic-trochaic asymmetries. NonFinality constraints, as we shall see in Chapter 5, also provide one of the theory's basic mechanisms for obtaining weight-sensitivity. The third type, Window constraints, govern alignment relationships between slope categories and their associated gridmarks. These will be central in analyzing trisyllabic stress windows.

4.2 NonFinality

The treatment of NonFinality in the proposed account differs from previous approaches in several respects. First, previous approaches have typically limited NonFinality to prohibiting primary or secondary stress on the final syllable of a prosodic word. NonFinality in the proposed approach may apply to a greater range of final constituents— feet, syllables, and moras— in a greater range of prosodic domains— prosodic words, feet, and syllables. Second, in previous approaches, NonFinality has typically played a crucial role in only a handful of patterns, most significantly in certain unbounded patterns (see, for example, Walker 1996) and in certain iambic patterns (see, for example, McCarthy and Prince 1993a and Kenstowicz 1995). In the proposed account, NonFinality is a crucial factor in these same cases, but it is also crucial in several additional cases, among these the trochaic double off-beat and internal ternary patterns. A third difference is the view of NonFinality as establishing minimal distances between gridmarks and the right edges of prosodic domains, rather than focusing on the status of a final element with respect to stress:

(11) Generalized NonFinality

NonFin (PCat1-GM, PCat2, PCat3): Every PCat1-level gridmark has some PCat2 descent category in the domain of PCat3.

In requiring that gridmarks of the specified level have a descent category of the specified size within the specified domain, NonFinality constraints establish a minimal distance— corresponding to the size of the descent category— that must intervene between a gridmark and the domain's right edge.

Any combination of gridmark level, descent category, and prosodic domain may participate in NonFinality constraints, so long as the combination is one conforming to the (6) eligibility restriction. There can be podal, syllabic, or moraic NonFinality constraints for prosodic word-level gridmarks in the domain of the prosodic word, and there can be syllabic or moraic NonFinality constraints for foot-level gridmarks within the domain of the prosodic word. There can also be syllabic or moraic NonFinality constraints for either foot- or

prosodic word-level gridmarks within the domain of the foot and moraic NonFinality constraints for either foot- or prosodic word-level gridmarks within the domain of the syllable.

Although each of these combinations are possible, I will focus on the set in (12) in this and the following chapter:

(12) Syllabic NonFinality Constraints

a. Syllabic NonFinality in the Prosodic Word

SNonFinality or NonFin (Ft-GM, Syll, PrWd): Every foot-level gridmark has a syllabic descent category within the domain of the prosodic word.

b. Syllabic NonFinality in the Foot

Trochee or NonFin (Ft-GM, Syll, Ft): Every foot-level gridmark has a syllabic descent category within the domain of the foot.

Moraic NonFinality Constraints

c. Moraic NonFinality in the Prosodic Word

MNonFinality or NonFin (Ft-GM, Mora, PrWd): Every foot-level gridmark has a moraic descent category within the domain of the prosodic word.

d. Moraic NonFinality in the Foot

ILength or NonFin (Ft-GM, Mora, Ft): Every foot-level gridmark has a moraic descent category within the domain of the foot.

e. Moraic NonFinality in the Syllable

OBranchFG or NonFin (Ft-GM, Mora, Syll): Every foot-level gridmark has a moraic descent category within the domain of the syllable.

OBranchPG or NonFin (PrWd-GM, Mora, Syll): Every PrWd-level gridmark has a moraic descent category within the domain of the syllable.

We will examine constraints requiring moraic NonFinality— the constraints of (12c-e)— in the discussion of weight-sensitivity in Chapter 5. Requiring moraic NonFinality in the domain of the prosodic word allows stress to be sensitive to the weight of a prosodic word's final syllable, requiring moraic NonFinality in the domain of the foot allows stress to be sensitive to the weight of a foot's final syllable, and requiring moraic NonFinality in the domain of the syllable allows stress to be sensitive to the weight of syllables generally. First, we will examine below the constraints requiring syllabic NonFinality— the constraints of (12a, b). We shall see that requiring syllabic NonFinality in the domain of the prosodic

word allows the theory to obtain variations on the trochaic maximal alternation and iambic minimal alternation patterns discussed in Chapter 3. It will also allow the proposal to obtain variations on unbounded stress patterns. In the discussion of NonFinality in the domain of the foot, we will focus on the minimality and directionality effects mentioned in Chapters 2 and 3.

4.2.1 Syllabic NonFinality in the Prosodic Word

SNonFinality, repeated in (13), is the particular constraint requiring syllabic NonFinality in the prosodic word, and it is the manifestation of NonFinality in the proposed account closest to the traditional constraint.

(13) Syllabic NonFinality in the Prosodic Word

SNonFinality or NonFin (Ft-GM, Syll, PrWd): Every foot-level gridmark has a syllabic descent category within the domain of the prosodic word.

In requiring that every foot-level gridmark have a syllabic descent category within the domain of a prosodic word, SNonFinality establishes a syllable as the minimal distance that must intervene between a foot-level gridmark and the prosodic word's right edge.

As (14) demonstrates, meeting this demand requires simply that a prosodic word's final syllable be stressless. It does not matter how many foot-level gridmarks a candidate has or where these entries occur, as long as they do not occur over the prosodic word's final syllable.

(14) Satisfaction of SNonFinality

$\sigma\sigma\sigma\sigma\sigma$	SNonFinality
a. $\begin{matrix} & x & & x & & x \\ \sigma & \sigma & \sigma & \sigma & \sigma & \sigma \end{matrix}$	
b. $\begin{matrix} & x & & x & & x & x \\ \sigma & \sigma & \sigma & \sigma & \sigma & \sigma \end{matrix}$	*

In (14), both candidates are prosodic words containing six syllables. Candidate (a) has foot-level gridmarks over the first, third, and fifth. Since every gridmark has a syllabic descent

category within the prosodic word— since every gridmark precedes a syllable within the prosodic word— candidate (a) incurs no violations of SNonFinality. Candidate (b) has foot-level gridmarks over the same syllables as candidate (a) but has an additional gridmark over the sixth syllable. Since the first three gridmarks each precede a syllable, they incur no violations. The fourth gridmark, however, does not precede a syllable, resulting in the (b) candidate’s single violation.

In the discussion that follows, we will examine the stress patterns of Choctaw, Aguaruna, Pintupi, and Piro to see how SNonFinality interacts with constraints producing binary patterns. Then, further below, we will examine the stress pattern of Yawelmani to see how SNonFinality interacts with constraints producing unbounded patterns.

4.2.1.1 Binary NonFinality Patterns

As far as I am aware, previous analyses of binary alternations have utilized NonFinality only in the context of the two iambic patterns, what I will call the iambic even offbeat and even downbeat patterns, illustrated in (15). To the left of the iambic patterns are their trochaic mirror images, apparently unattested.

(15) Additional Asymmetrically Attested Patterns

Even Offbeat

$$\begin{array}{cccccc} & & x & & x & \\ \sigma & \sigma & \sigma & \sigma & \sigma & \sigma \\ x & & x & & x & \\ \sigma & \sigma & \sigma & \sigma & \sigma & \sigma \end{array}$$

Unattested

$$\begin{array}{cccccc} & & x & & x & \\ \sigma & \sigma & \sigma & \sigma & \sigma & \sigma \\ x & & x & & x & \\ \sigma & \sigma & \sigma & \sigma & \sigma & \sigma \end{array}$$

Carib (Hoff 1968)
Choctaw (Nicklas 1972, 1975)
Hixkaryana (Derbyshire 1985)

Even Downbeat

$$\begin{array}{cccccc} & x & x & & x & \\ \sigma & \sigma & \sigma & \sigma & \sigma & \sigma \\ x & & x & & x & \\ \sigma & \sigma & \sigma & \sigma & \sigma & \sigma \end{array}$$

Unattested

$$\begin{array}{cccccc} & x & & x & x & \\ \sigma & \sigma & \sigma & \sigma & \sigma & \sigma \\ x & & x & & x & \\ \sigma & \sigma & \sigma & \sigma & \sigma & \sigma \end{array}$$

Aguaruna (D. Payne 1990)
Axininca Campa (D. Payne 1981)
Southern Paiute (Sapir 1930, 1949)

These additional asymmetrically attested patterns were not included in the discussion in Chapter 1, as we were focusing on questions of simple directionality and the standard account cannot obtain them simply by specifying foot-type and direction of alignment. The reason is straightforward. The distinguishing characteristic of the even offbeat pattern is a pair of adjacent stressless syllables at one edge or the other in *even*-parity forms, and the distinguishing characteristic of the even downbeat pattern is a pair of adjacent stressed syllables near one edge or the other in *even*-parity forms. In odd-parity forms, both patterns are identical to the minimal alternation pattern. Since the variations occur in the even-parity forms, they are not the result of an odd syllable and are not connected to directionality.

In obtaining the iambic even offbeat and even downbeat patterns, previous analyses have used NonFinality to force non-parsing of final syllables or to influence the shape of a final foot. For example, in Kenstowicz' (1995) analysis of Carib, ranking NonFinality over Parse-Syll causes the final two syllables of even-parity forms to remain unfooted, creating the characteristic iambic even offbeat pattern:

(16) NonFinality >> Parse-Syll

σσσσ	NonFinality	Parse-Syll
a. (σ́σ)σσ		* *
b. (σ́σ)(σ́σ)	* !	

In McCarthy and Prince's (1993a) analysis of Axininca Campa, ranking NonFinality over Ft-Form ("feet are iambic") causes even-parity forms to reverse their final feet from iambic to trochaic, creating the characteristic iambic even downbeat pattern:

(17) NonFinality >> Ft-Form

σσσσ	NonFinality	Ft-Form
a. (σ́σ)(σ́σ)		*
b. (σ́σ)(σ́σ)	* !	

The proposed analysis will use NonFinality to produce similar effects, but different structural assumptions and constraints will be involved. Since the proposed account does not tolerate non-parsing, violating MapGM (Ft) to produce stressless feet will be crucial in obtaining the iambic even offbeat pattern. Also, since foot-head alignment rather than a Ft-Form constraint is responsible for producing iambic feet, violating Hds-Right will be crucial in obtaining the iambic even downbeat pattern.

An additional contrast to the standard account is that these same interactions will be crucial in obtaining key trochaic patterns. Traditionally, NonFinality has not been prominent in the analysis of trochaic patterns. Partly due to its structural assumptions and partly due to its reliance on alignment constraints, analyses based on the standard account have not recognized the parallels between, first, the even offbeat and double offbeat patterns and, second, the even downbeat and internal ternary patterns:

(18) Comparison between Trochaic and Iambic Patterns

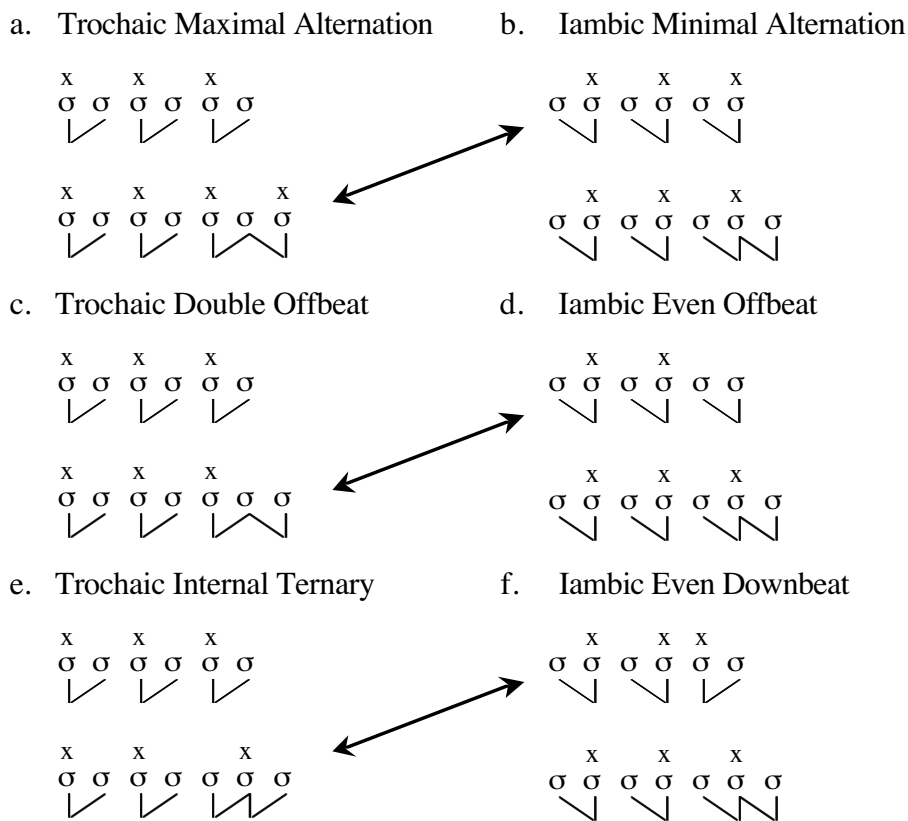

The iambic even offbeat and even downbeat patterns, shown with their proposed structures in (18d) and (18f) respectively, are variations on the iambic minimal alternation pattern, shown in (18b). The variations occur only in even-parity forms and then only in the final foot of even-parity forms. The final foot of the (18b) even-parity form is a stressed iamb, the final foot of the (18d) even-parity form is a stressless iamb, and the final foot of the (18f) even-parity form is a stressed trochee. The stressless final iamb of the even offbeat pattern (18d) produces the characteristic pair of stressless syllables at the right edge. The stressed final trochee of the even downbeat pattern (18f) produces the pair of adjacent stressed syllables near the right edge. The trochaic double offbeat and internal ternary patterns, shown with their proposed structures in (18c) and (18e) respectively, are variations on the trochaic maximal alternation pattern, shown in (18a). With the trochaic patterns, the variations occur only in odd-parity forms, but like the iambic patterns, the variations are limited to final feet. Parallel to the even-parity iambic (18b), the final foot of the odd-parity trochaic (18a) is a stressed iamb. Parallel to the even-parity iambic (18d) the final foot of the odd-parity trochaic (18c) is a stressless iamb. Finally, parallel to the final foot of the even-parity iambic (18f), the final foot of the odd-parity trochaic (18e) is a stressed trochee. The final stressless iamb of the double offbeat pattern (18c) produces the characteristic pair of stressless syllables at the right edge. The final stressed trochee of the internal ternary pattern (18e) produces a gridmark sharing configuration, resulting in the characteristic dactyl preceding the penult.

In addition to the parallels between the specific patterns listed above, there is a more general connection between the iambic and trochaic patterns of (18): the importance of Hds-Right in determining directionality. In Chapter 3, we saw that the iambic minimal alternation pattern was the optimal output of the constraints in (19), regardless of their ranking.

(19) Iambic Minimal Alternation Constraints

Hds-Right, MapGM (Ft), *Clash

We also saw that the trochaic maximal alternation pattern was the optimal output of the constraints in (20) when PrWd-L ranks over Hds-Right.

(20) Trochaic Maximal Alternation Constraints

PrWd-L, Hds-Right, MapGM (Ft), *Clash

Hds-Right, MapGM (Ft) and *Clash, then, are significant factors in both cases, the difference being that PrWd-L restricts the effects of Hds-Right in the trochaic pattern but not in the iambic pattern. These factors will also be significant in producing the desired variations.

4.2.1.1.1 Constraint Interactions

We saw in Chapter 3 that the proposed account produces the core binary alternation patterns with a handful of constraints: Hds-Left and Hds-Right, PrWd-L and PrWd-Right, *Clash, and MapGM (Ft). Most of these same constraints play a role in producing the attested patterns described above. Two, Hds-Right and MapGM (Ft), are especially significant in this context due to their interactions with SNonFinality.

Consider the competing preferences of SNonFinality and MapGM (Ft). In competitions between a candidate with a stressless final iamb, such as (21a) and a candidate with a stressed final iamb, such as (21b), SNonFinality will prefer the stressless iamb, and MapGM (Ft) will prefer the stressed iamb.



(21) SNonFinality and MapGM (Ft)

	SNonFinality	MapGM (Ft)
a. ... σ σ \diagdown		*
b. ... σ $\overset{x}{\sigma}$ \diagdown	*	

In (21), the candidates are the final foot of a prosodic word. Both feet are iambic, but the (a) candidate's foot is stressless, where the (b) candidate's foot is stressed. Although the (a) candidate's stressless foot produces a MapGM (Ft) violation, the fact that the final syllable is stressless makes it acceptable to SNonFinality. Although the (b) candidate's final stressed syllable incurs an SNonFinality violation, the fact that the foot is stressed makes it acceptable to MapGM (Ft).

Consider next the competing preferences of SNonFinality and Hds-Right. In competitions between a candidate with a stressed final trochee, such as (22a), and a stressed final iamb, such as (22b), SNonFinality will prefer the trochee, and Hds-Right will prefer the iamb.

(22) SNonFinality and Hds-Right

	SNonFinality	Hds-Right
a. ... $\overset{x}{\sigma} \sigma$ 		*
b. ... $\sigma \overset{x}{\sigma}$ 	*	

In (22), each candidate again represents the final foot of a prosodic word. Because the (a) candidate's foot is trochaic, it incurs a violation of Hds-Right, but because its stress does not occur on the final syllable, it is acceptable to SNonFinality. Because the (a) candidate is stressed on the final syllable it incurs an SNonFinality violation, but because the foot is iambic it is acceptable to Hds-Right.

Finally, consider the competing preferences of MapGM (Ft) and Hds-Right. When the satisfaction of SNonFinality is the foremost concern and when the competition is between a candidate with a stressed final trochee, such as (23a), and a stressless final iamb, such as (23b), MapGM (Ft) will prefer the stressed trochee, and Hds-Right will prefer the stressless iamb.

(23) MapGM (Ft) and Hds-Right



	MapGM (Ft)	Hds-Right
a. ... $\overset{x}{\sigma}$ σ \swarrow		*
b. ... σ σ \swarrow	*	

The candidates in (23) are the final foot of a prosodic word. Although the (a) candidate's trochee incurs a violation of Hds-Right, the fact that the foot is stressed makes it acceptable to MapGM (Ft). Although the (b) candidate's stressless foot incurs a MapGM (Ft) violation, the fact that it is an iamb makes it acceptable to Hds-Right.

Taken together, these three constraints— SNonFinality, Hds-Right, and MapGM (Ft)— are the core of the proposed analysis for both the iambic and trochaic patterns in (18). In patterns where Hds-Right is a significant factor in positioning foot-heads, as it is in each of the (18) patterns, the interactions between these constraints often determine the status of the final foot. The variations each occur under equally general circumstances. The final foot will be a stressed iamb when SNonFinality is the lowest ranked of the three constraints, the final foot will be a stressless iamb when MapGM (Ft) is the lowest ranked, and the final foot will be a stressed trochee when Hds-Right is the lowest ranked.

To illustrate, consider first the emergence of a stressed final iamb when Hds-Right and MapGM (Ft) rank above SNonFinality:



(24) Hds-Right, MapGM (Ft) >> SNonFinality

	Hds-Right	MapGM (Ft)	SNonFinality
a. ... $\overset{x}{\sigma}$ σ 			*
b. ... σ σ 		*!	
c. ... $\overset{x}{\sigma}$ σ 	*!		

In (24), Hds-Right screens out the (c) candidate's stressed final trochee, and MapGM (Ft) screens out the (b) candidate's stressless final iamb, leaving the (a) candidate's stressed final iamb as the winner. SNonFinality has no influence over the outcome. Notice that the ranking between Hds-Right and MapGM (Ft) is not crucial. All that matters is that both rank above SNonFinality. For example, if Hds-Right ranks above MapGM (Ft), Hds-Right screens out the stressed final trochee of candidate (c), and passes the decision between (a) and (b) on to MapGM (Ft). MapGM (Ft) screens out the stressless final iamb of candidate (b), leaving the stressed final iamb of candidate (a) as the winner. If MapGM (Ft) ranks above Hds-Right, MapGM (Ft) screens out the stressless final iamb of candidate (b) and passes the decision between (a) and (c) on to Hds-Right. Hds-Right screens out the stressed final trochee of candidate (c), leaving the stressed final iamb of candidate (a) as the winner.

Consider next the emergence of a stressless final iamb when SNonFinality and Hds-Right rank above MapGM (Ft):



(25) SNonFinality, Hds-Right >> MapGM (Ft)

	SNonFinality	Hds-Right	MapGM (Ft)
a. ... σ $\overset{x}{\sigma}$ 	*!		
b. ... σ σ 			*
c. ... $\overset{x}{\sigma}$ σ 		*!	

In (25), SNonFinality screens out the (a) candidate's stressed final iamb, and Hds-Right screens out the (c) candidate's stressed final trochee, leaving the (b) candidate's stressless final iamb as the winner. MapGM (Ft) has no effect on the outcome. The ranking between SNonFinality and Hds-Right is not crucial. All that matters is that both rank over MapGM (Ft). To illustrate, if SNonFinality ranks over Hds-Right, then SNonFinality screens out the stressed iamb of candidate (a) and passes the decision between (b) and (c) on to Hds-Right. Hds-Right screens out the stressed trochee of candidate (c), leaving the stressless iamb of candidate (b) as the winner. If Hds-Right ranks over SNonFinality, then Hds-Right screens out the stressed trochee of candidate (c) and passes the decision between (a) and (b) on to SNonFinality. SNonFinality screens out the stressed iamb of candidate (a), leaving the stressless iamb of candidate (b) as the winner.

Finally, consider the emergence of a stressed final trochee when SNonFinality and MapGM (Ft) rank above Hds-Right:

(26) SNonFinality, MapGM (Ft) >> Hds-Right

	SNonFinality	MapGM (Ft)	Hds-Right
a. ... σ $\overset{x}{\sigma}$ 	*!		
b. ... σ σ 		*!	
c. ... $\overset{x}{\sigma}$ σ 			*

In (26), SNonFinality screens out the (a) candidate's stressed final iamb, and MapGM (Ft) screens out the (b) candidate's stressless final iamb, leaving the (c) candidate's stressed final trochee as the winner. Hds-Right has no influence over the outcome. The ranking between SNonFinality and MapGM (Ft) is not crucial. All that matters is that both rank above Hds-Right. For example, if SNonFinality ranks above MapGM (Ft), SNonFinality screens out the stressed iamb of candidate (a) and passes the decision between (b) and (c) on to MapGM (Ft). MapGM (Ft) screens out the stressless iamb of candidate (b), leaving the stressed trochee of candidate (c) as the winner. If MapGM (Ft) ranks above SNonFinality, MapGM (Ft) screens out the stressless iamb of candidate (b) and passes the decision between (a) and (c) on to SNonFinality. SNonFinality screens out the stressed iamb of candidate (a), leaving the stressed trochee of candidate (c) as the winner.

To summarize, of the six possible rankings between SNonFinality, Hds-Right, and MapGM (Ft), two produce a stressed final iamb, two produce a stressless final iamb, and two produce a stressed final trochee:

(27) Summary of Rankings

- | | |
|---------------------------|--|
| a. Stressed Final Iamb | Hds-Right >> MapGM (Ft) >> SNonFinality
MapGM (Ft) >> Hds-Right >> SNonFinality |
| b. Stressless Final Iamb | SNonFinality >> Hds-Right >> MapGM (Ft)
Hds-Right >> SNonFinality >> MapGM (Ft) |
| c. Stressed Final Trochee | SNonFinality >> MapGM (Ft) >> Hds-Right
MapGM (Ft) >> SNonFinality >> Hds-Right |

A stressed final iamb emerges under the two rankings in (27a) where both Hds-Right and MapGM (Ft) rank above SNonFinality. A stressless final iamb emerges under the two rankings in (28b) where both SNonFinality and Hds-Right rank above MapGM (Ft). Finally, a stressed final trochee emerges under the two rankings in (28c) where SNonFinality and MapGM (Ft) both rank above Hds-Right.

Before examining in more detail the role that these rankings play in obtaining the (18) patterns, it is necessary to examine one further constraint interaction. In situations where a stressed syllable precedes a form's final foot, there may be a crucial interaction between SNonFinality and *Clash. In competitions between candidates with a stressed final trochee, such as (28a) and a stressed final iamb, such as (28b) SNonFinality will prefer the stressed final trochee and *Clash will prefer the stressed final iamb:

(28) SNonFinality and *Clash

	SNonFinality	*Clash
a. x x ... σ σ σ /		*
b. x x ... σ σ σ \	*	

The candidates in (28) show the antepenult and the final foot of a prosodic word. Depending on the weight and gridmark mapping of the antepenult, a clash configuration may result if it precedes a stressed trochee. Assuming that the status of the antepenult is such that it would produce clash (either light or heavy and monopositionally mapped), the (a) candi-

date's stressed final trochee produces a *Clash violation, but the fact that the final foot is a trochee makes it acceptable to SNonFinality. The (b) candidate's final stressed iamb produces an SNonFinality violation, but the fact that the final foot is an iamb allows it to avoid clash.

4.2.1.1.2 Stressed Final Iamb

Before examining their variations in more detail, it is necessary at this point to briefly reexamine the trochaic maximal alternation and iambic minimal alternation patterns, repeated in (29), in light of SNonFinality's introduction to the constraint set.

(29) Core Patterns

a. Trochaic Maximal Alternation

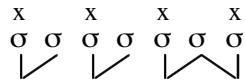
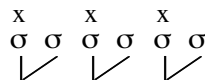

b. Iambic Minimal Alternation

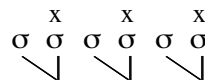

In Chapter 3, we saw that the iambic minimal alternation pattern was the optimal output of the constraints in (30), regardless of their ranking.

(30) Iambic Minimal Alternation Constraints

Hds-Right, MapGM (Ft), *Clash

We also saw that the trochaic maximal alternation pattern was the optimal output of the constraints in (31) when PrWd-L ranks over Hds-Right.

(31) Trochaic Maximal Alternation Constraints

PrWd-L, Hds-Right, MapGM (Ft), *Clash

Hds-Right, MapGM (Ft) and *Clash, then, are significant factors in both cases, the difference being that PrWd-L restricts the effects of Hds-Right in the trochaic pattern but not in the iambic pattern.

The sets of constraints in (30) and (31) are significant not only because they reveal important parallels in how the iambic and trochaic patterns are obtained, but they are also significant because they reveal why SNonFinality produces variations only in the even-parity forms of the iambic pattern and only in the odd-parity forms of the trochaic pattern. The ranking between the (30) constraints is not crucial in producing the iambic minimal alternation pattern. They all agree on a final stressed iamb in even-parity forms, which leaves the final syllable stressed, and on a final gridmark sharing configuration in odd-parity forms, which leaves the final syllable stressless. For odd-parity forms, introducing SNonFinality to the iambic minimal alternation constraint set, as in (32), can do nothing to alter the optimal output.

(32) Iambic Minimal Alternation Constraints Plus SNonFinality

Hds-Right, MapGM (Ft), *Clash, SNonFinality

Since Hds-Right, MapGM (Ft), and *Clash already all agree on a configuration for odd-parity forms where the final syllable is stressless, there are no consequences in introducing a specific demand that final syllables be stressless. This being the case, there are no issues that arise for the iambic odd-parity forms distinct from those addressed in Chapter 3, and I will not focus on them further.

For even-parity forms, introducing SNonFinality to the iambic minimal alternation constraint set can have an effect on the optimal output. Since Hds-Right, MapGM (Ft), and *Clash agree on a configuration for even-parity forms where the final syllable is stressed, introducing a specific demand that final syllables be stressless does have consequences. Because satisfying SNonFinality would necessitate violating either Hds-Right or MapGM (Ft), obtaining the iambic minimal alternation pattern requires that Hds-Right and MapGM (Ft) both rank above SNonFinality. As (33) demonstrates, ranking Hds-Right over SNonFinality ensures that a final foot-head cannot shift leftward, as in the (c) and (d) candidates, in order to avoid final stress, and ranking MapGM (Ft) over SNonFinality ensures that the final foot cannot be left stressless, as in the (b) candidate, in order to avoid final stress.

(33) Iambic Minimal Alternation: *Clash, Hds-Right, MapGM (Ft) >> SNonFinality

$\sigma\sigma\sigma\sigma\sigma$	*Clash	Hds-Right	MapGM (Ft)	SNonFin
a. $\begin{array}{ccccc} & x & & x & & x \\ \sigma & \sigma & \sigma & \sigma & \sigma & \sigma \\ & \swarrow & & \swarrow & & \swarrow \end{array}$		** *****		*
b. $\begin{array}{ccccc} & x & & x & & \\ \sigma & \sigma & \sigma & \sigma & \sigma & \sigma \\ & \swarrow & & \swarrow & & \swarrow \end{array}$		** *****	*!	
c. $\begin{array}{ccccc} & x & & x & & x \\ \sigma & \sigma & \sigma & \sigma & \sigma & \sigma \\ & \swarrow & & \swarrow & & \swarrow \end{array}$	*!	* ** *****!		
d. $\begin{array}{ccccc} x & & x & & x \\ \sigma & \sigma & \sigma & \sigma & \sigma & \sigma \\ \swarrow & & \swarrow & & \swarrow & \end{array}$		* *** **!*!***		

In (33), the (a) candidate exhibits the iambic minimal alternation pattern, the (b) candidate the even offbeat pattern, and the (c) candidate the even downbeat pattern. The (d) candidate exhibits a trochaic pattern. In this context, the ranking of *Clash is not crucial. *Clash merely duplicates the effect of Hds-Right in screening out the (c) candidates final stressed trochee. The crucial part of the ranking is Hds-Right, MapGM (Ft) >> SNonFinality. Hds-Right screens out the stressed final trochee of the (c) candidate's double downbeat pattern and the thoroughly trochaic footing of the (d) pattern. MapGM (Ft) screens out the stressless final iamb of the (b) candidate's double offbeat pattern. This leaves the (a) candidate's minimal alternation pattern and its stressed final iamb as the winner. Being ranked so low in the constraint set, SNonFinality has no influence over the outcome.

We also saw in Chapter 3 that in producing the trochaic maximal alternation pattern, the only crucial ranking among the (31) constraints is PrWd-L >> Hds-Right. Given this ranking, the constraints agree on a final stressed trochee in even-parity forms, which leaves the final syllable stressless, and a final stressed iamb in odd-parity forms, which leaves the final syllable stressed. For even-parity forms, introducing SNonFinality to the constraint set, as in (34), can do nothing to alter the optimal output.

(34) Trochaic Maximal Alternation Constraints Plus SNonFinality

PrWd-L, Hds-Right, MapGM (Ft), *Clash, SNonFinality

Since— given the crucial ranking PrWd-L >> Hds-Right— PrWd-L, Hds-Right, MapGM (Ft) and *Clash agree on a configuration for even-parity forms where the final syllable is stressless, there are no consequences in introducing a specific demand that final syllables be stressless. There are no issues, then, for the trochaic even-parity forms distinct from those already addressed, and I will ignore them in the discussion below.

For odd-parity forms, introducing SNonFinality to the constraint set can have an impact on the optimal output. Since PrWd-L, Hds-Right, MapGM (Ft) and *Clash agree on a configuration for odd-parity forms where the final syllable is stressed, there are consequences to introducing a specific demand that final syllables be stressless. Because satisfying SNonFinality would mean violating either Hds-Right or MapGM (Ft), obtaining the trochaic maximal alternation pattern requires that Hds-Right and MapGM (Ft) both rank above SNonFinality. In parallel to the iambic minimal alternation pattern above, and as (35) demonstrates, ranking Hds-Right over SNonFinality ensures that a final foot-head cannot shift leftward, as in the (c) and (d) candidates, in order to avoid final stress, and ranking MapGM (Ft) over SNonFinality ensures that the final foot cannot be left stressless, as in the (b) candidate, in order to avoid final stress.

(35) Trochaic Maximal Alternation: *Clash, PrWd-L >> Hds-Right, MapGM (Ft) >> SNonFinality

	σσσσσσ	*Clash	PrWd-L	Hds-Right	MapGM (Ft)	S NonFin
a.				** ***** ***** (12)		*
b.				** ***** ***** (12)	*!	
c.				* ** ***** *****! (13)		
d.				* *** ***** *****! (15)		
e.			*!	* *** ***** (9)		

In (35), the (a) candidate exhibits the trochaic maximal alternation pattern, the (b) candidate the double offbeat pattern, and the (c) candidate the internal ternary pattern. The (d) candidate exhibits the trochaic minimal alternation pattern and the (e) candidate exhibits the iambic minimal alternation pattern. As it does not distinguish between any of the candidates, the ranking of *Clash is not crucial. The crucial rankings are PrWd-L >> Hds-Right and Hds-Right, MapGM (Ft) >> SNonFinality. PrWd-Left establishes a basically trochaic pattern by screening out the iambic minimal alternation pattern of candidate (e), due to its initial iamb, and passing the decision between the trochaic (a-d) on to Hds-Right. Hds-Right and MapGM (Ft) establish the final foot as a stressed iamb. Hds-Right screens out the stressed final trochee of candidate (c) and the thoroughly trochaic footing of candidate (d). MapGM (Ft) screens out the stressless final iamb of candidate (b). This leaves stressed final iamb of candidate (a) as the winner. Because it has such a low ranking, SNonFinality does not have a chance to influence the outcome.

The iambic version of minimal alternation, then, and the trochaic version of maximal alternation both emerge under a low ranking of SNonFinality. Such a ranking allows for the best possible satisfaction of Hds-Right and MapGM (Ft) by tolerating stress on final syllables. As we shall see below, however, the variations on these core patterns are reactions to a high ranking SNonFinality, rankings which cause the violation of either Hds-Right or MapGM (Ft).

4.2.1.1.3 Stressless Final Iamb: Choctaw and Pintupi

The iambic even offbeat pattern occurs in languages like Carib, Choctaw (Nicklas 1972,1975, Munro and Ulrich 1984, Ulrich 1986; see also Lombardi and McCarthy 1991 and Hayes 1995), and Hixkaryana (Derbyshire 1985; see also Blevins 1990 and Hayes 1995). Example forms from Choctaw, combinations of pisa “to see”, čí- “you (object)”, -čí “causative”, and - li “I (subject)”, are given in (36).

(36) Choctaw Forms (from Nicklas 1975)

σσ	pisa
σ́σσ	čipí:sa
σ́σσσ	čipí:sali
σ́σσ́σσ	čipí:sačí:li

Stress in Choctaw occurs on every even-numbered syllable counting from the beginning of the form, except the final syllable. In even-parity forms, the absence of stress on the final syllable creates the characteristic pair of stressless syllables at the right edge. In disyllabic forms, this means that both syllables are stressless.

The trochaic double offbeat pattern occurs in languages like Mpakwithi (Crowley 1981), Pintupi (Hansen and Hansen, 1969), and Wangkumara (McDonald and Wurm 1979). Example forms from Pintupi are given in (37).

(37) Pintupi Forms (from Hansen and Hansen 1969)

óσ	pána	earth
óσσ	tjúṭaya	many
óσσσ	málawàna	through (from) behind
óσσσσ	púliṅkàlatju	we (sat) on the hill
óσσσσσ	tjámulìmpatjùṅku	our relation
óσσσσσσ	tíliṛìṅulàmpatju	the fire for our benefit flared up

Stress in Pintupi occurs on every odd-numbered syllable counting from the beginning of the form, except the final syllable. The absence of stress on the final syllable creates the characteristic pair of stressless syllables at the right edge in odd-parity forms. Primary stress is initial.

The trochaic double offbeat and iambic even offbeat patterns are parallel in that they both result from the same reaction to a high-ranking SNonFinality. Due to the preferences of the other relevant constraints, however— Hds-Right, MapGM (Ft), and *Clash— the reaction to a high ranking SNonFinality is not observable in the odd-parity forms of Choctaw’s iambic even offbeat pattern, shown in (38) using /čipí:sačí:li/. Neither is it observable in the even-parity forms of Pintupi’s trochaic double offbeat pattern, shown in (39) using /málawàna/. The reasons are the same as those discussed above for the odd-parity forms of the corresponding iambic minimal alternation pattern and the even-parity forms of the corresponding trochaic maximal alternation pattern.

(38) Choctaw Odd-Parity Pattern

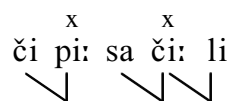

(39) Pintupi Even-Parity Pattern

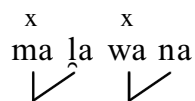

The reaction to a high ranking SNonFinality is only observable the iambic pattern's even-parity forms and the trochaic pattern's odd-parity forms. For even-parity forms in Choctaw, such as /pisa/ and /čipí:sali/, and odd-parity forms in Pintupi, such as /púliŋkàlatju/ and /tíliřìŋulàmpatju/, absence of stress on the final syllable results in a pair of stressless syllables at the right edge of the prosodic word. Since, in the proposed approach, all syllables must be footed and feet can be no larger than disyllabic, adjacent stressless syllables could only occur in this position if the final foot were stressless. Obtaining the desired result, then, requires that the foot-stress relationship be set aside in the final foot of the relevant forms.

As illustrated using Choctaw's /čipí:sali/ in (40) and Pintupi's /púliŋkàlatju/ in (41) ranking Hds-Right above MapGM (Ft) ensures that the final foot-head cannot be shifted leftward, as in the (c) candidates, in order to preserve the foot-stress relationship, and ranking SNonFinality above MapGM (Ft) ensures that the final syllable will not be stressed, as in the (a) candidates, in order to maintain the foot-stress relationship.

(40) Choctaw Even-Parity: *Clash, SNonFinality, Hds-Right >> MapGM (Ft)

čipisali	*Clash	SNonFinality	Hds-Right	MapGM (Ft)
a. č ^x i pi ^x : sa li		*!	**	
b. č ^x i pi ^x : sa li			**	*
c. č ^x i pi ^x : sa li			* **!	
d. č ^x i pi ^x sa li			* **!*	

In (40), the (a) candidate exhibits the iambic minimal alternation pattern, the (b) candidate the desired iambic even offbeat pattern, and the (c) candidate the iambic even downbeat pattern. The (d) candidate has thoroughly trochaic footing. The ranking of *Clash is not crucial here. Since the antepenult in the (c) candidate is heavy (and I will assume bimensionally mapped), no clash configuration is possible, and *Clash does not distinguish between the candidates. The crucial ranking is SNonFinality, Hds-Right >> MapGM (Ft), which determines the status of the final foot. SNonFinality screens out the stressed final iamb of candidate (a). Hds-Right screens out the stressed final trochee of candidate (c) and the thoroughly trochaic footing of candidate (d). This leaves the stressless final iamb of candidate (b) as the winner. Because of its low ranking, MapGM (Ft) does not have a chance to influence the outcome.

(41) Pintupi Odd-Parity: *Clash, PrWd-L >> SNonFinality, Hds-Right >> MapGM (Ft)

puliŋkalatju	*Clash	PrWd-L	SNonFin	Hds-Right	MapGM (Ft)
a. pu ^x liŋ ^x ka ^x la tju 			*!	** *****	
b. pu ^x liŋ ^x ka la tju 				** *****	*
c. pu ^x liŋ ka ^x la tju 				* ** *****!	
d. pu ^x liŋ ka ^x la tju 				* **** *****!*	
e. pu ^x liŋ ka ^x la tju 		*!		* ****	

In (41), the (a) candidate exhibits the trochaic maximal alternation pattern, the (b) candidate the desired trochaic double offbeat pattern, the (c) candidate the trochaic internal ternary

pattern, and the (d) candidate the trochaic minimal alternation pattern. The (e) candidate exhibits the iambic minimal alternation pattern. As it does not distinguish between any of the candidates, the ranking of *Clash is not crucial here. The crucial rankings are PrWd-L >> Hds-Right and SNonFinality, Hds-Right >> MapGM (Ft). PrWd-L establishes a basically trochaic pattern by screening out the iambic minimal alternation pattern of candidate (e) and passing the decision between the trochaic (a-d) on to SNonFinality and Hds-Right. SNonFinality and Hds-Right establish the final foot as a stressless iamb. SNonFinality screens out the stressed final iamb of candidate (a), and Hds-Right screens out the stressed final trochee of candidate (c) and the thoroughly trochaic footing of candidate (d). This leaves candidate (a) with its stressless final iamb as the winner. Due to its low ranking, MapGM (Ft) does not influence the outcome.

The trochaic double offbeat pattern, then, and the iambic even offbeat pattern both emerge as a reaction to a high ranking of SNonFinality where the demands of SNonFinality and Hds-Right are met at the expense of MapGM (Ft). Specifically, MapGM (Ft) is violated in the final foot of the trochaic double offbeat pattern's odd-parity forms and the iambic even offbeat pattern's even-parity forms, resulting in the characteristic pair of stressless syllables at the right edge in both types.

4.2.1.1.4 Stressed Final Trochee: Aguaruna and Piro

The iambic even downbeat pattern is exhibited by languages like Aguaruna (D. Payne 1990; see also Hung 1994), Axininca Campa (D. Payne 1981; see also McCarthy and Prince 1993a), and Southern Paiute (Sapir 1930, 1949; see also Hayes 1981 and Halle and Vergnaud 1987). Example forms from Aguaruna are given in (42).

(42) Aguaruna Forms (from Hung 1994)¹

óσ	núka	<i>leaf (nom)</i>
óóσ	čañkína	<i>basket (nom)</i>
óóóσ	ičínàka	<i>pot (nom)</i>
óóóóσ	ičínakàna	<i>pot (acc)</i>
óóóóóσ	čañkínañùmìna	<i>your basket (acc)</i>
óóóóóóσ	čañkínañùminàki	<i>only your basket (acc)</i>

Stress in Aguaruna occurs on the penult and, counting from the beginning of the form, on every even-numbered syllable preceding the penult. For even-parity forms, this means that both the penult and antepenult are stressed, giving rise to the characteristic pair of adjacent stressed syllables near the right edge. The leftmost stress is the primary stress.

The trochaic internal ternary pattern occurs in languages like Lenakel (Lynch 1974, 1977, 1978; see also Hammond 1986 and Hayes 1995), Piro (Matteson 1965), and Polish (Rubach and Booij 1985). Example forms from Piro are given in (43).

(43) Piro Forms (from Matteson 1965)

óσ	wálo	<i>rabbit</i>
óóσ	rutxítxa	<i>he observes taboo</i>
óóóσ	t̃šiyaháta	<i>he cries</i>
óóóóσ	sàlwayehkáta	<i>they visit each other</i>
óóóóóσ	pèt̃šhit̃šimatlóna	<i>they say they stalk it</i>
óóóóóóσ	rùslunòtinitkána	<i>their voices already changed</i>

Stress in Piro occurs on the penult and, counting from the beginning of the form, on every odd-numbered syllable preceding the penult, except the antepenult. The absence of stress on the antepenult creates a dactyl preceding the rightmost stress in odd-parity forms. The rightmost stress is also the primary stress.

¹ In Hung 1994, the position of stress is inferred by the absence of vowel reduction processes, which according to D. Payne 1990 can be devoicing in some dialects and deletion in others.

For the same reasons mentioned above with respect to the iambic minimal alternation and trochaic maximal alternation patterns, the variations produced by SNonFinality in Aguaruna's iambic even downbeat pattern are not observable in its odd-parity forms, as illustrated using /ičínakàna/ in (44). Neither are the variations produced by SNonFinality in Piro's trochaic internal ternary pattern observable in its even-parity forms, as illustrated using /tšiyaháta/ in (45).

(44) Aguaruna Odd-Parity Pattern

$$\begin{array}{cccc} & x & & x \\ i & \check{c}i & na & ka & na \\ \swarrow & & \swarrow & \swarrow & \swarrow \end{array}$$

(45) Piro Even-Parity Pattern

$$\begin{array}{cccc} & x & & x \\ \check{t}š & i & ya & ha & ta \\ \swarrow & & \swarrow & & \swarrow \end{array}$$

Since Hds-Right, MapGM (Ft), and *Clash already agree on final stresslessness in these types, the introduction of SNonFinality has no effect.

Although the odd-parity forms of the trochaic internal ternary pattern and the even-parity forms of the iambic even downbeat pattern both utilize a final stressed trochee in reacting to a high ranking SNonFinality, exercising this option produces different results in the two types. In the odd-parity forms of the trochaic Piro, such as /sàlwayehkáta/ and /rùslunòtinitkána/, when the type of the final foot is reversed from iambic to trochaic, the shifted head occurs in an intersection, and the possibility of a gridmark sharing configuration is established. Piro exploits this configuration by shifting stress from the antepenult, where it occurs in the maximal alternation and double offbeat patterns, to the penult so that the final two feet both occur with a foot-level gridmark while avoiding clash. Absence of stress on the antepenult means that there are two adjacent stressless syllables preceding the penult, creating the appearance of a dactyl preceding the rightmost stress. In the even-parity

forms of the iambic Aguaruna, such as /ičínàka/ and /čaŋkínaŋùmìna/, where there are no intersections, reversing the type of the final foot from iambic to trochaic does not result in a gridmark sharing configuration. Rather, it produces a configuration where the final trochee follows an iamb. Since their heads are adjacent, stressing both feet results in the pair of adjacent stressed syllables characteristic of the type.

To obtain the desired result for either type, it is necessary that both SNonFinality and MapGM (Ft) rank above Hds-Right. As (46) illustrates using Aguaruna's /ičínàka/ and (47) illustrates using Piro's /sàlwayehkáta/, ranking MapGM (Ft) above Hds-Right ensures that the final foot cannot be left stressless, as in the (b) candidates, in order to avoid leftward movement of the final foot-head, and ranking SNonFinality above Hds-Right ensures that the final syllable cannot be stressed, as in the (a) candidates, in order to avoid leftward movement of the final foot-head.

(46) Aguaruna Even-Parity: SNonFinality, MapGM (Ft) >> Hds-Right >> *Clash

ičínaka	SNonFinality	MapGM (Ft)	Hds-Right	*Clash
a. $\begin{array}{c} \text{ } \quad \text{x} \quad \text{x} \\ \text{i} \quad \check{\text{c}}\text{i} \quad \text{na} \quad \text{ka} \\ \quad \swarrow \quad \searrow \end{array}$	*!		* *	
b. $\begin{array}{c} \text{ } \quad \text{x} \\ \text{i} \quad \check{\text{c}}\text{i} \quad \text{na} \quad \text{ka} \\ \quad \swarrow \quad \searrow \end{array}$		*!	* *	
c. $\begin{array}{c} \text{ } \quad \text{x} \quad \text{x} \\ \text{i} \quad \check{\text{c}}\text{i} \quad \text{na} \quad \text{ka} \\ \quad \swarrow \quad \searrow \end{array}$			* **	*
d. $\begin{array}{c} \text{x} \quad \text{x} \\ \check{\text{i}} \quad \check{\text{c}}\text{i} \quad \text{na} \quad \text{ka} \\ \swarrow \quad \searrow \end{array}$			* ***!	

In the Aguaruna example in (46), the (a) candidate exhibits the iambic minimal alternation pattern, the (b) candidate the iambic even offbeat pattern, and the (c) candidate the desired iambic even downbeat pattern. The (d) candidate has a thoroughly trochaic pattern. The cru-

cial rankings are SNonFinality, MapGM (Ft) >> Hds-Right and, given the light antepenult, Hds-Right >> *Clash. Ranking SNonFinality and MapGM (Ft) over Hds-Right establishes the final foot as a stressed trochee. SNonFinality screens out the final stressed iamb of candidate (a), and MapGM (Ft) screens out the final stressless iamb of candidate (b), passing the decision between (c, d) on to Hds-Right. Hds-Right establishes a basically iambic pattern by screening out the thoroughly trochaic candidate (d), leaving the iambic downbeat pattern of candidate (c) as the winner. Due to its low ranking, *Clash, which would have preferred candidate (d) over candidate (c), does not have a chance to influence the outcome.

(47) Piro Odd-Parity: *Clash, PrWd-L >> SNonFinality, MapGM (Ft) >> Hds-Right

salwayehkata	*Clash	PrWd-L	SNonFin	MapGM (Ft)	Hds-Right
$\begin{array}{c} x \quad x \quad x \\ \text{a. sal wayehka ta} \\ \swarrow \quad \searrow \quad \swarrow \end{array}$			*!		** *****
$\begin{array}{c} x \quad x \\ \text{b. sal wayehka ta} \\ \swarrow \quad \searrow \quad \swarrow \end{array}$				*!	** *****
$\begin{array}{c} x \quad x \\ \text{c. sal wayehka ta} \\ \swarrow \quad \searrow \quad \swarrow \end{array}$					* ** *****
$\begin{array}{c} x \quad x \\ \text{d. sal wayehka ta} \\ \swarrow \quad \swarrow \quad \swarrow \end{array}$					* *** *****!
$\begin{array}{c} x \quad x \\ \text{e. sal wayehka ta} \\ \swarrow \quad \searrow \quad \swarrow \end{array}$		*!			* ***
$\begin{array}{c} x \quad x \quad x \\ \text{f. sal wayehka ta} \\ \swarrow \quad \searrow \quad \swarrow \end{array}$	*!				* ** *****

In the Piro example in (47), the (a) candidate exhibits the trochaic maximal alternation pattern, the (b) candidate the trochaic double offbeat pattern, and the (c) candidate the desired trochaic internal ternary pattern. The (d) candidate exhibits the trochaic minimal alternation

pattern, and the (e) candidate exhibits the iambic minimal alternation pattern. The (f) candidate is an additional close competitor to the desired (c) candidate, the difference between them being that (c) exploits a gridmark sharing configuration to avoid clash where (f) does not. Although the ranking of *Clash is not crucial, its presence allows the gridmark sharing configuration of candidate (c) to harmonically bound the clashing configuration of candidate (f). The crucial rankings are PrWd-L >> Hds-Right and SNonFinality, MapGM (Ft) >> Hds-Right. PrWd-L establishes a basically trochaic pattern by screening out the iambic minimal alternation pattern of candidate (e) and passing the decision between the trochaic (a-d) on to the remaining constraints. SNonFinality and MapGM (Ft) establish the final foot as a stressed trochee. SNonFinality screens out the stressed final iamb of candidate (a), and MapGM (Ft) screens out the stressless final iamb of candidate (b), leaving the trochaic internal ternary pattern of candidate (c) as the winner. Because of its low ranking, Hds-Right does not influence the outcome.

Although the iambic double downbeat pattern and the trochaic internal ternary pattern appear to be quite different on the surface, both patterns are a reaction to a high-ranking SNonFinality where the demands of SNonFinality are met at the expense of Hds-Right. In the even-parity forms of the iambic pattern, ranking SNonFinality and MapGM (Ft) over Hds-Right produces a final trochee preceded by a string of iambs. This results in the pair of adjacent stressed syllables near the right edge. In the odd-parity forms of the trochaic pattern, the ranking produces a final gridmark sharing configuration. This results in the pair of adjacent stressless syllables preceding the penult.

4.2.1.1.5 Predicting Asymmetries

Although it has often been noted in the literature that there is little evidence for effects like those produced by NonFinality (or its predecessor extrametricality) at the beginning of a form, this circumstance is especially significant in the context of the iambic-trochaic asymmetries under consideration. Not only must the theory be able to produce the variations on

iambic minimal alternation and trochaic maximal alternation just discussed, it is also necessary that the theory be unable to produce the mirror images of these patterns. In other words, the theory must not only provide an account of why the iambic even offbeat and even downbeat patterns and the trochaic double offbeat and internal ternary patterns are attested, it must also provide an account of why the trochaic even offbeat and even downbeat patterns and the iambic double offbeat and internal ternary patterns are unattested.

Given the structures assumed by the proposed account, the absence of the mirror image patterns can be traced to the absence of a constraint that is the mirror of SNonFinality. Because the characteristic configurations of the attested patterns are variations in the final foot of a prosodic word, the introduction of SNonFinality to the constraint set provides the theory with a mechanism for producing the attested configurations. As we shall see below, however, the characteristic configurations of the unattested patterns are variations in the initial foot of a prosodic word. Since neither SNonFinality nor any other constraint in the proposal can produce the required variations in an initial foot, the proposal does not have a mechanism for producing the unattested configurations.

Just as the iambic even offbeat and even downbeat patterns above were variations on iambic minimal alternation, the trochaic even offbeat and even downbeat patterns, shown in (48b) and (48c), respectively, with what would be their structures under the proposed account, would be considered variations on trochaic minimal alternation, shown in (48a).

(48) Trochaic Mirror Image Patterns

a. Minimal Alternation

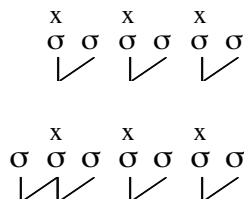

b. Even Offbeat

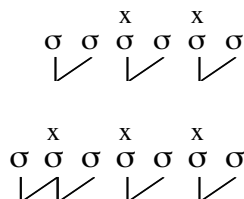

c. Even Downbeat

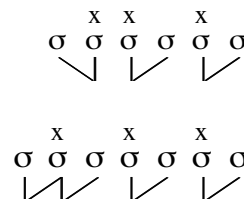

As with the iambic variations on minimal alternation, the trochaic variations in (48) occur only in even-parity forms and then only in a single foot in even-parity forms. Unlike the iambic variations, however, the trochaic variations occur in the initial foot. The initial foot of

the trochaic minimal alternation even-parity form in (a) is a stressed trochee, the initial foot of the trochaic even offbeat even-parity form in (b) is a stressless trochee, and the initial foot of the trochaic even downbeat even-parity form in (c) is a stressed iamb. In the even offbeat even-parity form, the initial stressless trochee produces the characteristic pair of stressless syllables at the left edge. In the even downbeat even-parity form, the initial stressed iamb results in the characteristic pair of clashing gridmarks near the left edge.

Although the introduction of SNonFinality to the constraint set allows the grammar to prefer a final stressless iamb or a final stressless trochee— the variations that result in the iambic even offbeat and even downbeat patterns— over what otherwise would have been the final stressed iamb of the iambic minimal alternation pattern, no constraint has been introduced to the constraint set that would allow the grammar to prefer an initial stressless trochee or an initial stressed iamb— the variations that would result in the trochaic even offbeat and even downbeat patterns— over what otherwise would be the initial stressed trochee of the trochaic minimal alternation pattern.

In more formal terms, the introduction of SNonFinality to the constraint set prevents the iambic minimal alternation pattern from harmonically bounding the iambic even offbeat and even downbeat patterns. In contrast, and as (49) demonstrates, no constraint has been introduced to the constraint set which would prevent the trochaic minimal alternation pattern from harmonically bounding the trochaic even offbeat and even downbeat patterns.

(49) Trochaic Patterns: Hds-Left, MapGM (Ft), SNonFinality

$\sigma\sigma\sigma\sigma\sigma$	Hds-Left	MapGM (Ft)	*Clash	SNonFinality
a. $\begin{array}{ccccc} & x & & x & & x \\ \sigma & \sigma & \sigma & \sigma & \sigma & \sigma \\ & \swarrow & & \swarrow & & \swarrow \end{array}$	** *****			
b. $\begin{array}{ccccc} & & & x & & x \\ \sigma & \sigma & \sigma & \sigma & \sigma & \sigma \\ & \swarrow & & \swarrow & & \swarrow \end{array}$	** *****	*		
c. $\begin{array}{ccccc} & & & x & & x & & x \\ \sigma & \sigma & \sigma & \sigma & \sigma & \sigma \\ & \swarrow & & \swarrow & & \swarrow \end{array}$	* ** *****		*	

In (49), the relevant constraints are the trochaic minimal alternation constraints— Hds-Left, MapGM (Ft) and *Clash— and SNonFinality. Each of the candidates are six-syllable prosodic words. The (a) candidate exhibits the trochaic minimal alternation pattern, the (b) candidate the trochaic even offbeat pattern, and the (c) candidate the trochaic even downbeat pattern. Since the minimal alternation (a) performs equally to the even off-beat (b) on Hds-Left, *Clash, and SNonFinality and better on MapGM (Ft), (a) will prevail over (b) under every possible ranking. Since the minimal alternation (a) performs equally to the even downbeat (c) on MapGM (Ft) and SNonFinality and better on Hds-Left and *Clash, (a) will prevail over (c) under every possible ranking. The trochaic minimal alternation pattern, then, harmonically bounds both the trochaic even offbeat and even downbeat patterns, and the grammar is unable to obtain either type.

The reasons for the asymmetry in attestation of the double offbeat and internal ternary patterns are similar, only, in this case, it is the trochaic versions that are attested and the iambic versions that are unattested. The iambic double offbeat and internal ternary patterns, shown with what would be their structures in the proposed account in (50b) and (50c) respectively, would be variations on the iambic maximal alternation pattern, shown in (50a).

(50) Iambic Mirror Image Patterns

a. Maximal Alternation

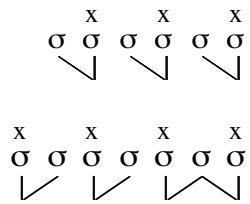

b. Double Offbeat

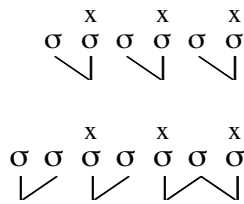

c. Internal Ternary

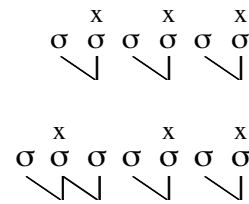

As with the trochaic variations on maximal alternation discussed above, the iambic variations occur only in odd-parity forms and then only in a single foot in odd-parity forms. Unlike the trochaic variations, however, the iambic variations occur in the initial foot. The initial foot in the iambic minimal alternation odd-parity form in (a) is a stressed trochee, the initial foot in the iambic double offbeat odd-parity form in (b) is a stressless trochee, and the initial foot in the iambic internal ternary odd-parity form in (c) is a stressed iamb. In the double offbeat odd-parity form, the initial stressless trochee produces the characteristic pair of stressless syllables at the left edge. In the internal ternary pattern, the initial stressed iamb produces a gridmark sharing configuration, resulting in a characteristic anapest following the peninitial stress.

Just as introducing SNonFinality to the constraint set allows the grammar to prefer the stressless final iamb and stressed final trochee of the iambic even offbeat and iambic even downbeat patterns over the stressed final trochee of the iambic minimal alternation pattern, introducing SNonFinality to the constraint set allows the grammar to prefer the stressless final iamb and stressed final trochee of the trochaic double offbeat and internal ternary patterns over the stressed final iamb of the trochaic maximal alternation pattern. Also, just as no constraint has been introduced to the constraint set that would allow the grammar to prefer the stressless initial trochee and stressed initial iamb of the trochaic even offbeat and even downbeat patterns over the stressed initial trochee of the trochaic minimal alternation pattern, no constraint has been introduced to the constraint set that would allow the grammar to prefer the stressless initial trochee and the stressless initial iamb of the iam-

bic double offbeat and internal ternary patterns over the stressed initial trochee of the iambic maximal alternation pattern.

In more formal terms, introducing SNonFinality to the constraint set prevents the trochaic maximal alternation pattern from harmonically bounding the trochaic double offbeat and internal ternary patterns. In contrast, and as (51) demonstrates, no constraint has been introduced to the constraint set which would prevent the iambic maximal alternation pattern from harmonically bounding the iambic double offbeat and internal ternary patterns.

(51) Iambic Patterns: PrWd-R, Hds-Left, MapGM (Ft), SNonFinality

$\sigma\sigma\sigma\sigma\sigma\sigma$	PrWd-R	Hds-Left	MapGM (Ft)	*Clash	SNonFin
a. $\begin{array}{cccc} x & & x & & x & & x \\ \sigma & \sigma & \sigma & \sigma & \sigma & \sigma & \sigma \\ \swarrow & \swarrow & \swarrow & \swarrow & \swarrow & \swarrow & \swarrow \end{array}$		** ** ** ** ** ** ** ** (12)			*
b. $\begin{array}{cccc} & & x & & x & & x \\ \sigma & \sigma & \sigma & \sigma & \sigma & \sigma & \sigma \\ \swarrow & \swarrow & \swarrow & \swarrow & \swarrow & \swarrow & \swarrow \end{array}$		** ** ** ** ** ** ** ** (12)	*		*
c. $\begin{array}{cccc} & & x & & x & & x \\ \sigma & \sigma & \sigma & \sigma & \sigma & \sigma & \sigma \\ \swarrow & \swarrow & \swarrow & \swarrow & \swarrow & \swarrow & \swarrow \end{array}$		* * * * * * * * * * * * (13)			*

In (51), the relevant constraints are SNonFinality and the iambic maximal alternation constraints— PrWd-R, Heads-Left, MapGM (Ft), and *Clash. Each of the candidates are seven-syllable forms. The (a) candidate exhibits the iambic maximal alternation pattern, the (b) candidate the iambic double offbeat pattern, and the (c) candidate the iambic internal ternary pattern. Since the maximal alternation (a) performs equally to the double offbeat (b) on PrWd-R, Hds-Left, *Clash, and SNonFinality and better on MapGM (Ft), there is no possible ranking where candidate (a) will not prevail over candidate (b). Since the maximal alternation (a) performs equally to the internal ternary (c) on PrWd-R, MapGM (Ft), *Clash, and SNonFinality and better on Hds-Left, there is no possible ranking where candidate (a) will not prevail over candidate (c). The iambic maximal alternation pattern, then, harmoni-

cally bounds the iambic double offbeat pattern and the iambic internal ternary pattern, and the grammar is unable to obtain either type.

4.2.1.1.6 Summary

In our examination of NonFinality thus far, we have seen that SNonFinality prevents the iambic minimal alternation pattern from harmonically bounding the iambic even offbeat and even downbeat patterns but does not prevent the trochaic minimal alternation pattern from harmonically bounding trochaic even offbeat and even downbeat patterns. The proposal is thus able to produce the attested iambic versions of the even downbeat and even offbeat types without also being able to produce the unattested trochaic mirror images. Similarly, we have seen that the introduction of SNonFinality to the constraint set prevents the trochaic maximal alternation pattern from harmonically bounding the trochaic double offbeat and internal ternary patterns but does not prevent the iambic maximal alternation pattern from harmonically bounding the iambic double offbeat and internal ternary patterns. The proposal is thus able to produce the attested trochaic versions of the internal ternary and double offbeat types without also being able to produce the unattested iambic mirror images. We have also examined in greater detail the particular rankings that allow the individual attested patterns to emerge:

- (52) Summary of Core Rankings
- a. Iambic Minimal Alternation/Trochaic Maximal Alternation
Hds-Right, MapGM (Ft) >> SNonFinality
 - b. Iambic Even Offbeat/Trochaic Double Offbeat
Hds-Right, SNonFinality >> MapGM (Ft)
 - c. Iambic Even Downbeat/Trochaic Internal Ternary
MapGM (Ft), SNonFinality >> Hds-Right

As summarized in (52), the trochaic maximal alternation pattern and iambic minimal alternation pattern are parallel in that both result from a low ranking of SNonFinality, the trochaic double offbeat pattern and the iambic even offbeat pattern are parallel in that both result

from a low ranking MapGM (Ft), and the trochaic internal ternary pattern and the iambic even downbeat pattern are parallel in that both result from a low ranking Hds-Right.

4.2.1.2 Unbounded NonFinality Patterns: Yawelmani

Having seen the effects of SNonFinality in binary alternating systems, it is important to show that SNonFinality plays a role in other types of systems as well. We can see the effects of SNonFinality on an unbounded stress system in the pattern of Yawelmani (Kroeber 1963 and Newman 1944). Example forms are given below:

(53) Yawelmani Forms (from Walker 1996)

LHL	xomó:ti	<i>south</i>
HLH	sapsábits	<i>mouse</i>
HHH	go:lánkil	<i>king snake</i>
LLL	melikáno	<i>white man</i>

In Yawelmani, a single stress occurs on the penult regardless of the length of the form or the weight of the syllables involved. Yawelmani is similar to the Uzbek pattern discussed in Chapter 3, then, in that a single stress occurs as far to the right as possible within each form. Yawelmani differs from the Uzbek pattern, however, in that the final syllable is not available to carry stress.

Given the similarity between the Yawelmani and Uzbek patterns, it might seem at first glance that the Yawelmani pattern could be obtained simply by augmenting the Uzbek ranking, repeated in (54), by inserting SNonFinality above FG-Right, as in (55).

(54) Uzbek Ranking

FG-Right >> MapGM (Ft)

(55) Uzbek Ranking plus SNonFinality

SNonFinality >> FG-Right >> MapGM (Ft)

This approach, however, is not quite adequate. In the (54) Uzbek ranking, FG-Right can be satisfied in one of two ways. It can be satisfied non-vacuously by positioning a single foot-level gridmark at the right edge of the prosodic word, or it can be satisfied vacuously by

leaving the entire form stressless. The gridmark is preserved at the right edge because non-vacuous satisfaction of FG-Right allows for better satisfaction of the lower ranked MapGM (Ft). In the (55) ranking, if SNonFinality is to be satisfied, it is only possible to satisfy FG-Right vacuously. Since it would be possible, then, to satisfy both simultaneously with a stressless candidate, SNonFinality and FG-Right would agree on an output that is entirely stressless.

An additional constraint is needed to force the minimal violation of FG-Right. MapGM (Ft) is not appropriate because, as we saw in Chapter 3, ranking MapGM (Ft) above FG-Right would simply produce a binary (or ternary) stress pattern. Inserting MapGM (PrWd) above FG-Right, however, along with SNonFinality, as in (56), will produce the desired results.

(56) Yawelmani Ranking

MapGM (PrWd), SNonFinality >> FG-Right >> MapGM (Ft)

As demonstrated using [melikáno] in (57), Ranking MapGM (PrWd) over FG-Right prevents vacuous satisfaction of the gridmark alignment constraints, as in candidate (e), and ensures that the output form actually has a stress. Ranking SNonFinality over FG-Right, prevents stress from occurring on the final syllable, as in candidate (d), in order to better satisfy rightward gridmark alignment. FG-Right, however, still has sufficient influence to prevent the occurrence of additional gridmarks, as in candidate (c), and to prevent primary stress from occurring to the left of the penult, as in candidate (b).

(57) MapGM (PrWd), SNonFinality >> FG-Right >> MapGM (Ft)

melikano	MapGM (PrWd)	SNonFinality	FG-Right	MapGM (Ft)
a. x x me li ka no ✓ ✓			*	*
x x me li ka no ✓ ✓			**!	*
x x x me li ka no ✓ ✓			* *! **	
x x me li ka no ✓ ✓		*!		*
me li ka no ✓ ✓	*!			**

In (57), candidate (a) has a single stress on the penult, candidate (b) has a single stress on the initial syllable, and candidate (c) has stress on both the initial syllable and the penult. Candidate (d) has a single stress on the final syllable, and candidate (e) is stressless. Ranking MapGM (PrWd) and SNonFinality over FG-Right ensures that the output will have at least one non-final stress. MapGM (PrWd) screens out the stressless candidate (e), and SNonFinality screens out the final stress of candidate (d), passing (a-c) on to FG-Right. FG-Right ensures that stress is limited to the penult by screening out the multiple stresses of candidate (c) and the antepenultimate stress of candidate (b). This leaves the desired candidate (a) as the winner. Given its low ranking, MapGM (Ft) does not have a chance to influence the outcome.

4.2.2 Syllabic NonFinality within the Foot

At several points in the previous chapters, I have alluded to NonFinality constraints within the domain of the foot. There are two types: moraic NonFinality, which I will discuss in connection with weight-sensitivity in Chapter 5, and syllabic NonFinality, which I will examine below. Although constraints promoting NonFinality for prosodic word-level gridmarks are possible in both cases under the general definition from (11), I will focus on the constraints that promote NonFinality for foot-level gridmarks. The first, Trochee, is given in (58).

(58) NonFinality within the Foot

Trochee or NonFin (Ft-GM, Syll, Ft): Every foot-level gridmark has a syllabic descent category within the domain of the foot.

By requiring that each foot-level gridmark have a syllabic descent category within the domain of a foot, Trochee demands that the final syllable of each foot be stressless. This can be accomplished in two ways. The first is for the foot itself to be stressless. Because stressless feet have no foot-level gridmarks to require syllabic descent categories, such feet vacuously satisfy the Trochee constraint.

The second way is for the foot to be trochaic. As (59) demonstrates, monosyllables, whether light, as in candidate (d), or heavy, as in candidate (e), violate Trochee; and iambs, whether with a light final syllable, as in candidate (b), or a heavy final syllable, as in candidate (c), also violate Trochee.

(59) Satisfaction of Trochee

	Trochee
a. $\begin{array}{c} x \\ \sigma \quad \sigma \\ \swarrow \quad \searrow \end{array}$	
b. $\begin{array}{c} \mu \quad \mu \\ \sigma \quad \sigma \\ \swarrow \quad \searrow \end{array}$	*
c. $\begin{array}{c} \mu \quad \mu \quad \mu \\ \sigma \quad \sigma \\ \swarrow \quad \searrow \end{array}$	*
d. $\begin{array}{c} x \\ \mu \\ \sigma \\ \end{array}$	*
e. $\begin{array}{c} x \\ \mu \quad \mu \\ \sigma \\ \end{array}$	*

In (59), the feet of candidates (b-e) violate Trochee because the foot-level gridmarks associated with these feet do not have a syllabic descent category within the domain of the foot. Only the trochaic foot of candidate (a) meets this requirement.

Before examining the effects of the Trochee constraint in more detail, there are two general considerations that deserve further scrutiny. First, like those of SNonFinality and other NonFinality constraints in general, the effects of Trochee are asymmetrical. Trochee prohibits stress on the final syllable of a foot, but neither Trochee nor any other constraint in the proposal prohibits stress on the initial syllable. Second, because we are now discussing NonFinality at the foot level, and we will encounter situations where intersection and gridmark sharing commonly occur, it becomes necessary to say something further about the domain reference of NonFinality constraints in general. To illustrate, in the configurations

in (60), it must be determined whether we should take the reference to the domain of a foot in the Trochee constraint to mean the first foot, the second foot, either foot, or both feet.

(60) NonFinality in an Intersection

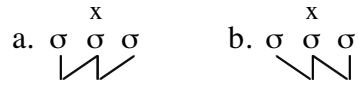

Example (60a) is a pair of intersecting trochees in a gridmark sharing configuration, and example (60b) is a pair of intersecting iambs, also in a gridmark sharing configuration. If we take reference to the domain of a foot to mean both feet or the first foot alone, then both configurations will violate Trochee, as neither gridmark has a syllabic descent category in the domain of the first foot. If the domain is taken to be either foot or the second foot alone, then both configurations will satisfy Trochee, as the gridmarks both have a syllabic descent category in the domain of the second foot. For reasons that will become clearer as we proceed, the reference to a domain in NonFinality constraints must be to the domain containing the head with which the relevant gridmark is associated. In the case of the intersecting trochees in (a), this would be the second foot, meaning that the constraint would be satisfied. In the case of the intersecting iambs in (b), it would be the first foot, meaning that the constraint is violated.

The Trochee constraint is important for two reasons. First, it provides a mechanism for producing trochaic feet without providing a similar mechanism for producing iambic feet. This is in line with the general observation from Chapter 1 that there are likely more ways to produce a trochaic foot-type than an iambic foot-type, and it gives the grammar the ability to specify trochaic footing independently of foot-head alignment. Second, in producing trochaic feet, Trochee also produces disyllabic feet. This has consequences for foot minimality and related word minimality phenomena.

4.2.2.1 Trochees

We have already seen how NonFinality within the foot will prefer trochaic footing over iambic footing when the optimal position of foot-heads in a form is consistent with either type. In Chapter 3, I argued that such a situation occurs in the odd-parity forms of trochaic and iambic maximal alternation patterns, both of which designate every odd-numbered syllable as a foot-head, and that NonFinality within the foot resolves the ambiguity in both cases in favor of the candidate which most thoroughly exhibits trochaic footing. The relevant tableaux are repeated in (61) and (62).

(61) Possible Footings for Maximal Alternation

$\sigma\sigma\sigma\sigma\sigma\sigma$	PrWd-L	PrWd-R	Hds-Left	Hds-Right
a. $\sigma \ \sigma \ \sigma \ \sigma \ \sigma \ \sigma$ 			** ***** *****	** ***** *****
b. $\sigma \ \sigma \ \sigma \ \sigma \ \sigma \ \sigma$ 			** ***** *****	** ***** *****
c. $\sigma \ \sigma \ \sigma \ \sigma \ \sigma \ \sigma$ 			** ***** *****	** ***** *****

(62) Preferences of Trochee

$\sigma\sigma\sigma\sigma\sigma\sigma$	Trochee
a. $\sigma \ \sigma \ \sigma \ \sigma \ \sigma \ \sigma$ 	*
b. $\sigma \ \sigma \ \sigma \ \sigma \ \sigma \ \sigma$ 	**
c. $\sigma \ \sigma \ \sigma \ \sigma \ \sigma \ \sigma$ 	***

The tableau in (61) demonstrates that the alignment constraints typically responsible for determining foot-type are not able to do so in the case of maximal alternation odd-parity forms. The tableau in (62) illustrates how the preferences of Trochee resolve the ambiguity.

The ability of Trochee to specify a trochaic foot-type independently of foot-head alignment means that it is possible for the two to conflict. This circumstance, for example,

gives the grammar a second and more direct method for obtaining the trochaic internal ternary pattern. Unlike the SNonFinality-based method discussed above, the second method does not rely on PrWd-L and the Lapse Condition to circumscribe the effects of Hds-Right; rather the effects of Hds-Right are circumscribed by the Trochee constraint. As (63) demonstrates using the seven-syllable Piro form /rùslunòtinitkána/, ranking both MapGM (Ft) and Trochee above Hds-Right obtains the desired result. Ranking MapGM (Ft) over Hds-Right eliminates the possibility of allowing feet to remain stressless, as in candidate (d), in order to maintain iambic footing, and thus the best possible rightward foot-head alignment. Ranking Trochee over Hds-Right ensures that stressed feet cannot be stressed on their final syllable, as in candidate (c), in order to maintain iambic footing, and thus the best possible rightward foot-head alignment. Finally, although it is at the bottom of the ranking and does not determine foot-type, Hds-Right still controls footing directionality by ensuring that an intersection occurs at the right edge of the prosodic word rather than at the left edge, as in candidate (b).

(63) MapGM (Ft), Trochee >> Hds-Right

ruslunotinitkana	MapGM	Trochee	Hds-Right
$\begin{array}{c} \text{x} \quad \text{x} \quad \text{x} \\ \text{a. ru sl u no ti ni tka na} \\ \swarrow \quad \swarrow \quad \swarrow \swarrow \end{array}$			$\begin{array}{c} * \quad * \quad * \quad * \quad * \\ * \quad * \quad * \quad * \quad * \\ (13) \end{array}$
$\begin{array}{c} \text{x} \quad \text{x} \quad \text{x} \\ \text{b. ru sl u no ti ni tka na} \\ \swarrow \swarrow \quad \swarrow \quad \swarrow \end{array}$			$\begin{array}{c} * \quad * \quad * \quad * \quad * \quad * \\ * \quad * \quad * \quad * \quad ! \quad * \\ (15) \end{array}$
$\begin{array}{c} \text{x} \quad \text{x} \quad \text{x} \\ \text{c. ru sl u no ti ni tka na} \\ \swarrow \quad \swarrow \quad \swarrow \swarrow \end{array}$		*!***	$\begin{array}{c} * \quad * \quad * \quad * \quad * \quad * \\ (9) \end{array}$
$\begin{array}{c} \text{d. ru sl u no ti ni tka na} \\ \swarrow \quad \swarrow \quad \swarrow \swarrow \end{array}$	*!***		$\begin{array}{c} * \quad * \quad * \quad * \quad * \quad * \\ (9) \end{array}$

In (63), candidate (d) drops out first. By leaving its iambic feet stressless, candidate (d) is able both to satisfy Trochee and to have the best possible rightward foot-head alignment for the length of the form. The stressless feet, however, cause (d) to have multiple violations of MapGM (Ft) where (a-c) have none. Although its stressed iambic feet allow candidate (c) to satisfy MapGM (Ft) and to exhibit the best possible rightward foot-head alignment for the length of the form, (c) drops out because these same feet lead to multiple violations of Trochee where (a) and (b) have none. Candidate (b) performs just as well on MapGM (Ft) and Trochee as candidate (a), but candidate (b) is eliminated because the position of its intersection causes it to have more violations than (a) of Hds-Right. This leaves candidate (a), the desired candidate, as the winner.

Although the tableau in (63) demonstrates the basic interactions of the ranking, one additional candidate should be considered. The comparison illustrates why the foot domain reference of the Trochee constraint must apply only to a foot whose head is associated with the relevant gridmark. Notice in the intersection of the desired candidate—(a) in (64) below—that the shared gridmark is final in the first foot (the foot whose head is not associated with the gridmark) but that it is not final in the second foot (the foot whose head is associated with the gridmark).

(64) Trochee >> Hds-Right

ruslunotinitkana	Trochee	Hds-Right
σ a. ru slu no ti ni tka na 		* * * * * * * * * * (13)
b. ru slu no ti ni tka na 	*!	* * * * * * * * * * (12)

Since only the second foot in the intersection counts as an appropriate domain for Trochee, candidate (a) has no violations. This gives it enough of an advantage over a candidate like (b), which has a final monosyllabic foot and one violation of Trochee, to emerge as the win-

ner. However, if the first foot in the intersection of candidate (a) also had to be counted as an appropriate domain, then (a) would actually have one violation of Trochee, tying it with (b) on this constraint and passing on the decision to Hds-Right. Since it has fewer violations of Hds-Right than (a), candidate (b) would incorrectly emerge as the winner.

The (63) ranking has much the same effect for even-parity forms as it does for odd-parity forms, except that footing directionality is absent. As (65) demonstrates using the six-syllable Piro form /pētšhitšimatlóna/, ranking MapGM (Ft) over Hds-Right prevents feet from being left stressless, as in candidate (c), order to maintain iambic footing, and ranking Trochee over Hds-Right prevents feet from being stressed on the final syllable, as in candidate (b), in order to maintain iambic footing. Also, although it is not demonstrated in the tableau, Hds-Right is responsible for the absence of intersections and monosyllables.

(65) MapGM (Ft), Trochee >> Hds-Right

petšhitšimatlóna	MapGM	Trochee	Hds-Right
a. $\overset{x}{pe} \overset{x}{t\check{s}hi} \overset{x}{t\check{s}i} \text{ mat lo na}$ 			* *** ***** (8)
b. $\overset{x}{pe} \overset{x}{t\check{s}hi} \overset{x}{t\check{s}i} \text{ mat lo na}$ 		*!***	** ***** (6)
c. $\overset{x}{pe} \overset{x}{t\check{s}hi} \overset{x}{t\check{s}i} \text{ mat lo na}$ 	*!***		** ***** (6)

Candidate (c) drops out first. Although leaving its feet stressless allows (c) to maintain iambic footing, and thus the best possible rightward foot-head alignment for the length of the form, this same situation also causes (c) to have multiple violations of MapGM (Ft) where (a) and (b) have none. Stressing the final syllables of the feet in candidate (b) allows it to satisfy MapGM (Ft) and to maintain iambic footing, but (b) drops out because this same situation leads to multiple violations of Trochee where (a) has none. Although its stressed

trochaic feet cause candidate (a) to incur more violations of Hds-Right, they also allow (a) to do well enough on the higher Trochee and MapGM (Ft) to emerge as the winner.

Similarly to the way in which SNonFinality reversed the foot-type of the final foot in the internal ternary and even downbeat patterns above, Trochee can cause foot-type reversal throughout a form. Trochee, however, not only prefers trochaic feet over iambic feet, but as demonstrated in (59) above, it also prefers trochaic feet over monosyllabic feet. In other words, Trochee demands that feet be minimally disyllabic.

4.2.2.2 Minimality

One consequence of Trochee’s preference for disyllabic feet is that it promotes minimally disyllabic words. Although word minimality is typically framed in terms of a word’s being minimally bimoraic, there are languages where the minimal word can or must be described as disyllabic. Among the languages that I have mentioned in this or previous chapters, Bidyara/Gungabula (Breen 1973), Cavinena (Key 1968), and Wangkumara (McDonald and Wurm 1979) fall into this category (for additional languages see Hayes 1995). The analysis is fairly straightforward. Because each form must contain at least one foot— due to Strict Layering— and because a highly ranked Trochee constraint can insist that this foot be trochaic, each word must have a minimum of two syllables.

A second consequence of Trochee’s preference for disyllabic feet is that it promotes intersections over monosyllables even when intersection does not offer the advantages of a gridmark sharing configuration. For example, I noted in Chapter 1 that the odd-parity forms of the trochaic double downbeat pattern, as illustrated in (66), and the edge ternary pattern, as illustrated in (67), could be obtained either with intersections or with monosyllables.

(66) Double Downbeat Options

a. Intersection

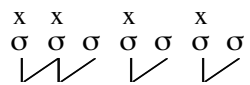

b. Monosyllabic Foot

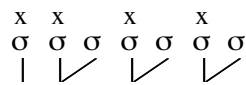

(67) Edge Ternary Options

a. Intersection

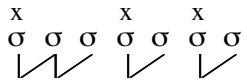

b. Monosyllabic Foot

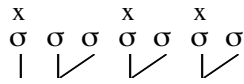

Because the foot-heads and gridmarks occur in the same positions in both (66a) and (66b), there is no difference between them with respect to their performance on the relevant constraints— Hds-Left, MapGM (Ft), *Clash, and Initial Gridmark. For the same reason, there is no difference between (67a) and (67b).

The Trochee constraint, however, resolves the ambiguity. Because intersection allows the feet to be trochaic, and thus to have non-final stress, Trochee prefers intersections over monosyllables:

(68) Trochee and the Double Downbeat Pattern

σσσσσσσ	Trochee
<p>a. $\begin{array}{cccc} x & x & x & x \\ \sigma & \sigma & \sigma & \sigma \\ \swarrow & \swarrow & \swarrow & \swarrow \end{array}$</p>	
<p>b. $\begin{array}{cccc} x & x & x & x \\ \sigma & \sigma & \sigma & \sigma \\ & \swarrow & \swarrow & \swarrow \end{array}$</p>	*!

(69) Trochee and the Edge Ternary Pattern

σσσσσσσ	Trochee
<p>a. $\begin{array}{cccc} x & & x & x \\ \sigma & \sigma & \sigma & \sigma \\ \swarrow & \swarrow & \swarrow & \swarrow \end{array}$</p>	
<p>b. $\begin{array}{cccc} x & & x & x \\ \sigma & \sigma & \sigma & \sigma \\ & \swarrow & \swarrow & \swarrow \end{array}$</p>	*!

In (68) and (69), the (b) candidates have monosyllables at the left edge of the prosodic word where the (a) candidates have intersections. Because the monosyllabic feet of the (b) candidates do not allow their associated foot-level gridmarks to have a syllabic descent category,

the (b) candidates violate Trochee. The (a) candidates, however, by extending their initial feet forward into an intersection, are able to provide the associated foot-level gridmarks with a descent category, thus, satisfying Trochee.

4.2.3 Summary

In our examination of NonFinality thus far, we have seen examples of both syllabic NonFinality in the prosodic word and syllabic NonFinality in the foot. SNonFinality is crucial in obtaining the correct predictions for key asymmetrically attested patterns, and Trochee allows the grammar both to specify a trochaic foot-type independently of foot-head alignment and to promote disyllabic minimality. Additional NonFinality constraints, constraints demanding moraic NonFinality in various domains will be central to the discussion of weight-sensitivity in Chapter 5. Next, however, we turn to a second type of constraint based on the Slope Category System, the Initial Gridmark constraints.

4.3 Initial Gridmark

As we saw in Chapter 1, the purpose of Initial Gridmark constraints is to position an appropriate gridmark at the left edge of a form. The grammar accomplishes this under the Slope Category System by requiring all instances of certain prosodic categories to be descent categories for an appropriate gridmark; in other words, by requiring all instances of certain prosodic categories to follow a gridmark of the appropriate level:

(70) Generalized Initial Gridmark

IntGrid (PCat, PCat2-GM): Every PCat1 is a descent category for some PCat2-level gridmark in some domain.

Although formulations involving either podal or moraic descent categories are also possible under the general definition in (70), the Initial Gridmark constraints that will concern us here both involve syllabic descent categories:

(71) Initial Gridmark Constraints

IntFG or IntGrid (Syll, Ft-GM): Every syllable is a descent category for some foot-level gridmark in some domain.

IntPG or IntGrid (Syll, PrWd-GM): Every syllable is a descent category for some PrWd-level gridmark in some domain.

Both IntFG and IntPG demand that each of the syllables in a form be descent categories for an appropriate gridmark in some domain. In other words, they both demand that each syllable in a form follow an appropriate gridmark in some domain. The difference between the two constraints is in the gridmark levels they refer to. IntFG demands that each syllable in a form follow a foot-level gridmark in some domain, and IntPG demands that each syllable in a form follow a prosodic word-level gridmark in some domain.

To better understand how the constraints in (71) work to achieve the desired results, we need to consider three factors: the asymmetry of reference to slope categories, the optionality in the phrase “in some domain”, and the impossibility of perfect satisfaction.

First, Initial Gridmark constraints derive their asymmetrical effect— being able to position appropriate gridmarks at the left edge of a form but not at the right edge— from the fact that they refer only to descent categories and not to ascent categories. Because they can require syllables to be descent categories, IntFG and IntPG can require each syllable to follow an appropriate gridmark, but because they cannot require syllables to be ascent categories, they cannot require syllables to precede an appropriate gridmark.

Second, the optionality in the phrase “in some domain” promotes the presence of an appropriate gridmark entry over the initial syllable of a form rather than over the initial syllable of some smaller domain within the form. Consider the six-syllable prosodic word in (72).

(72) Domain Optionality



The six syllables are parsed into three feet, with foot-level gridmarks occurring over the first and fifth syllables. If the IntFG constraint, for example, referred specifically to the domain of the foot— every syllable must follow a foot-level gridmark in the domain of a foot— only the second and sixth syllables would satisfy this requirement. By allowing the constraint access also to the prosodic word domain, however, the third, fourth, and fifth syllables are able to satisfy the constraint as well. Similarly, if a form were to have multiple prosodic words, it would not be necessary to have a gridmark entry over the initial syllable of each prosodic word. A syllable's designation as a descent category for the appropriate level gridmark in some even larger prosodic domain would also be acceptable, meaning that a form-initial gridmark would still be sufficient for the best possible satisfaction of the constraint.

Finally, due to structural limitations, it is not possible for any candidate to be in total compliance with either IntFG or IntPG. Because all gridmarks necessarily occur within the domain of some syllable, there will be at least one syllable in every candidate that cannot follow an appropriate gridmark. The best that any candidate can do is to have a gridmark on its initial syllable, allowing all other syllables to be its descent categories. In other words, any candidate allowed by the theory's structural assumptions will have at least one violation of IntFG and one violation of IntPG.

In simplest terms, then, the further away the leftmost appropriate gridmark is from a candidate's left edge, the more violations of IntFG or IntPG the candidate incurs. This is demonstrated for IntFG in (73) and for IntPG in (74).

(73) Violations of IntFG

$\sigma\sigma\sigma\sigma\sigma$	IntFG
a. $\begin{array}{cccccc} & x & & x & & x \\ \sigma & \sigma & \sigma & \sigma & \sigma & \sigma \end{array}$	*
b. $\begin{array}{cccccc} & & & x & & x \\ \sigma & \sigma & \sigma & \sigma & \sigma & \sigma \end{array}$	***
c. $\begin{array}{cccccc} & & & & & x \\ \sigma & \sigma & \sigma & \sigma & \sigma & \sigma \end{array}$	*****

(74) Violations of IntPG

$\sigma\sigma\sigma\sigma\sigma$	IntPG
a. $\begin{array}{cccccc} & x & & & & \\ & x & & x & & x \\ \sigma & \sigma & \sigma & \sigma & \sigma & \sigma \end{array}$	*
b. $\begin{array}{cccccc} & & & x & & \\ & x & & x & & x \\ \sigma & \sigma & \sigma & \sigma & \sigma & \sigma \end{array}$	***
c. $\begin{array}{cccccc} & & & & & x \\ & x & & x & & x \\ \sigma & \sigma & \sigma & \sigma & \sigma & \sigma \end{array}$	*****

In (73), each of the candidates is a six-syllable form. In candidate (c), a single foot-level gridmark occurs over the fifth syllable. Since the first through fifth syllables do not follow a foot-level gridmark, they cannot be descent categories in any domain, and candidate (c) incurs five IntFG violations. In candidate (b), a foot-level gridmark occurs over the third syllable in addition to the fifth. As the first through third syllables do not follow a foot-level gridmark, they cannot be descent categories, and candidate (b) incurs three IntFG violations. Candidate (a) is an example of the best possible satisfaction of the constraint. It has a foot-level gridmark over the first syllable in addition to those over the third and fifth. Since only the first syllable does not follow a foot-level gridmark, candidate (a) incurs only one IntFG violation. In (74), each of the candidates is a six-syllable form with foot-level gridmarks over the first, third, and fifth syllables. Notice that, although each of the candidates has a

form-initial foot-level gridmark, this circumstance offers no advantages with respect to IntPG. The only relevant factor is the position of the prosodic word-level gridmark, occurring in (c) over the fifth syllable, in (b) over the third syllable, and in (a) over the first syllable. As the number of syllables preceding the prosodic word-level gridmark decreases going from (c) to (a), the number of IntPG violations also decreases. Candidate (a) exemplifies the constraint's best possible satisfaction with only one violation.

In the discussion that follows, we will explore the role of IntFG in obtaining the correct predictions for the asymmetrically attested double downbeat and edge ternary patterns from the typology in Chapter 1. First, we will examine the crucial interactions between IntFG and other relevant constraints. Second, we will examine how these interactions produce the trochaic double downbeat and edge ternary patterns as variations on trochaic minimal alternation. Third, I will show in general terms why the proposal is not also able to obtain the unattested iambic mirror images of these variations. Finally, we will examine a subtler role for IntFG in Chimalapa Zoque (Knudson 1975), a language whose stress pattern more closely resembles those of unbounded systems than those of binary alternating systems. An example involving IntPG will be presented in the discussion of Cahuilla further below.

4.3.1 Constraint Interactions

In the proposed account, the trochaic double downbeat and edge ternary patterns, shown with their proposed structures in (75b) and (75c) respectively, are considered to be variations on the trochaic minimal alternation pattern, shown in (75a).

(75) Trochaic Variations

a. Minimal Alternation

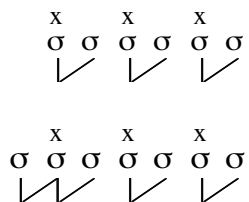

b. Double Downbeat

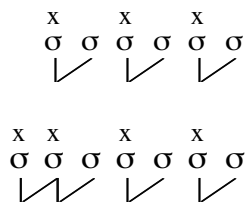

c. Edge Ternary

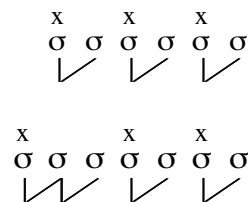

There is no difference between the even-parity forms. The variations occur only in odd-parity forms and then only in the gridmark mapping of the intersection at the left edge in odd-parity forms. The intersection of the (a) minimal alternation odd-parity form exhibits a gridmark sharing configuration, the intersection of the (b) double downbeat odd-parity form has a separate stress over the head of each foot, and the intersection of the (c) edge ternary odd-parity form has stress for the first foot but not the second. The separate stresses of the double downbeat pattern (b) produce the characteristic clash configuration at its left edge. The stressless foot of the edge ternary pattern (c) produces the characteristic “initial dactyl” at its left edge.

As discussed in Chapter 3, the constraints most relevant to producing the trochaic minimal alternation pattern are Hds-Left, MapGM (Ft), and *Clash. Through its interactions with these constraints, IntFG is able to produce variations on minimal alternation corresponding to the (b) and (c) patterns of (75) above. Although variations will result from interactions with each of the core constraints, for reasons I will mention further below, I will focus on the interactions between IntFG, MapGM (Ft), and *Clash.

First, consider the competing preferences of IntFG and *Clash for the mapping of the intersection at the left edge of odd-parity forms. In competitions between candidates with an initial clash configuration, such as (76a), and an initial gridmark sharing configuration, such as (76b), IntFG will prefer clash, and *Clash will prefer gridmark sharing.

(76) IntFG and *Clash

	IntFG	*Clash
a. $\begin{array}{c} x \quad x \\ \sigma \quad \sigma \quad \sigma \quad \dots \\ \swarrow \quad \searrow \quad \swarrow \end{array}$	*	*
b. $\begin{array}{c} x \\ \sigma \quad \sigma \quad \sigma \quad \dots \\ \swarrow \quad \searrow \quad \swarrow \end{array}$	**	

In (76), the candidates are the initial two trochaic feet of a prosodic word, and they occur in an intersecting configuration. A foot-level gridmark occurs in the intersection in both candidates, but the (a) candidate also has stress on its initial syllable where the (b) candidate's initial syllable is stressless. Although the (a) candidate's adjacent stressed syllables produce a *Clash violation, the fact that the initial syllable is stressed makes it more acceptable to IntFG. Although the (b) candidate's stressless initial syllable incurs an additional IntFG violation, the lack of adjacent stressed syllables makes it acceptable to *Clash.

Second, consider the competing preferences of IntFG and MapGM (Ft). In competitions between candidates with a stressless foot, such as (77a), and a gridmark sharing configuration, such as (77b), IntFG will prefer the stressless foot, and MapGM (Ft) will prefer the gridmark sharing configuration.

(77) IntFG and MapGM (Ft)

	IntFG	MapGM (Ft)
a. $\overset{x}{\sigma} \sigma \sigma \dots$ 	*	*
b. $\sigma \overset{x}{\sigma} \sigma \dots$ 	**	

In (77), each candidate again represents the initial two intersected feet of a prosodic word. Because the second foot of the (a) candidate is stressless, it incurs a violation of MapGM (Ft), but because it does have stress on its initial syllable, candidate (a) is more acceptable to IntFG. Because the (b) candidate does not have stress on its initial syllable it incurs an additional IntFG violation, but because a foot-level gridmark occurs within the domain of both feet, candidate (b) is acceptable to MapGM (Ft).

Finally, consider the competing preferences of *Clash and MapGM (Ft). When the competition is between candidates with a stressless foot, such as (78a), and a clash configu-

ration, such as (78b), *Clash will prefer the stressless foot, and MapGM (Ft) will prefer the clash configuration.

(78) *Clash and MapGM (Ft)

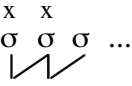
	*Clash	MapGM (Ft)
a. $\overset{x}{\sigma} \sigma \sigma \dots$ 		*
b. $\overset{x}{\sigma} \overset{x}{\sigma} \sigma \dots$ 	*	

The candidates in (78) are the initial two feet of a prosodic word. Although the (a) candidate's stressless foot incurs a violation of MapGM (Ft), its avoidance of adjacent stressed syllables makes it acceptable to *Clash. Although the (b) candidate's adjacent stressed syllables incur a *Clash violation, the fact that both feet have a gridmark within their domains makes it acceptable to MapGM (Ft).

The interactions between these three constraints— IntFG, *Clash, and MapGM (Ft)— will form the core of the proposed analysis for the trochaic patterns in (75). The (75) variations each occur under equally general circumstances. The gridmark sharing configuration of the minimal alternation pattern will emerge when IntFG is the lowest ranked of the three constraints, the clash configuration of the double downbeat pattern will emerge when *Clash is the lowest ranked, and the stressless foot of the edge ternary pattern will emerge when MapGM (Ft) is the lowest ranked.

To illustrate, consider the emergence of a gridmark sharing configuration when *Clash and MapGM (Ft) rank above IntFG:

(79) *Clash, MapGM (Ft) >> IntFG

	*Clash	MapGM (Ft)	IntFG
a. $\begin{array}{c} x \\ \sigma \quad \sigma \quad \sigma \quad \dots \\ \diagdown \quad \diagup \end{array}$			**
b. $\begin{array}{c} x \quad x \\ \sigma \quad \sigma \quad \sigma \quad \dots \\ \diagdown \quad \diagup \end{array}$	*!		*
c. $\begin{array}{c} x \\ \sigma \quad \sigma \quad \sigma \quad \dots \\ \diagdown \quad \diagup \end{array}$		*!	*

In (79), MapGM (Ft) screens out the (c) candidate's stressless second foot, and *Clash screens out the (b) candidate's adjacent stressed syllables, leaving the (a) candidate's gridmark sharing configuration as the winner. IntFG is not able to influence over the outcome. Notice that the ranking between *Clash and MapGM (Ft) is not crucial. All that matters is that both rank above IntFG. For example, if *Clash ranks above MapGM (Ft), *Clash screens out the adjacent stressed syllables of candidate (b), and passes the decision between (a) and (c) on to MapGM (Ft). MapGM (Ft) screens out the second stressless foot of candidate (c), leaving the (a) candidate's gridmark sharing configuration as the winner. If MapGM (Ft) ranks above *Clash, MapGM (Ft) screens out the stressless foot of candidate (c) and passes the decision between (a) and (b) on to *Clash. *Clash screens out the adjacent stressed syllables of candidate (b), leaving the gridmark sharing configuration of candidate (a) as the winner.

Consider next the emergence of a clash configuration when IntFG and MapGM (Ft) rank above *Clash:

(80) IntFG, MapGM (Ft) >> *Clash

	IntFG	MapGM (Ft)	*Clash
a. $\begin{array}{c} x \\ \sigma \ \sigma \ \sigma \ \dots \\ \swarrow \ \searrow \ \swarrow \ \searrow \end{array}$	**!		
b. $\begin{array}{c} x \ x \\ \sigma \ \sigma \ \sigma \ \dots \\ \swarrow \ \searrow \ \swarrow \ \searrow \end{array}$	*		*
c. $\begin{array}{c} x \\ \sigma \ \sigma \ \sigma \ \dots \\ \swarrow \ \searrow \ \swarrow \ \searrow \end{array}$	*	*!	

In (80), IntFG screens out the (a) candidate's stressless initial syllable, and MapGM (Ft) screens out the (c) candidate's stressless second foot, leaving the (b) candidate's clash configuration as the winner. *Clash has no effect on the outcome. The ranking between IntFG and MapGM (Ft) is not important. All that matters is that both rank above *Clash. To illustrate, if IntFG ranks over MapGM (Ft), then IntFG screens out the (a) candidate's initial stressless syllable and passes the decision between (b) and (c) on to MapGM (Ft). MapGM (Ft) screens out the (c) candidate's stressless foot, leaving the (b) candidate's clash configuration as the winner. If MapGM (Ft) ranks over IntFG, then MapGM (Ft) screens out the (c) candidate's stressless foot and passes the decision between (a) and (b) on to IntFG. IntFG screens out the (a) candidate's stressless initial syllable, leaving the (b) candidate's clash configuration as the winner.

Finally, consider the emergence of a stressless foot when IntFG and *Clash rank above MapGM (Ft):

(81) IntFG, *Clash >> MapGM (Ft)

	IntFG	*Clash	MapGM (Ft)
a. $\begin{array}{c} x \\ \sigma \ \sigma \ \sigma \ \dots \\ \swarrow \ \searrow \ \swarrow \ \searrow \end{array}$	**!		
b. $\begin{array}{c} x \ x \\ \sigma \ \sigma \ \sigma \ \dots \\ \swarrow \ \searrow \ \swarrow \ \searrow \end{array}$	*	*!	
c. $\begin{array}{c} x \\ \sigma \ \sigma \ \sigma \ \dots \\ \swarrow \ \searrow \ \swarrow \ \searrow \end{array}$	*		*

In (81), IntFG screens out the (a) candidate's stressless initial syllable, and *Clash screens out the (b) candidate's adjacent stressed syllables, leaving the (c) candidate's stressless second foot as the winner. MapGM (Ft) has no influence over the outcome. The ranking between IntFG and *Clash is unimportant. All that matters is that both rank above MapGM (Ft). For example, if IntFG ranks above *Clash, IntFG screens out the stressless initial syllable of candidate (a) and passes the decision between (b) and (c) on to *Clash. *Clash screens out the adjacent stressed syllables of candidate (b), leaving the stressless foot of candidate (c) as the winner. If *Clash ranks above IntFG, *Clash screens out the adjacent stressed syllables of candidate (b) and passes the decision between (a) and (c) on to IntFG. IntFG screens out the stressless initial syllables of candidate (a), leaving the stressless foot of candidate (c) as the winner.

To summarize, of the six possible rankings between IntFG, *Clash, and MapGM (Ft), two produce a gridmark sharing configuration, two produce a clash configuration, and two produce a stressless second foot:

(82) Summary of Rankings

- | | |
|------------------------|--|
| a. Gridmark Sharing | MapGM (Ft) >> *Clash >> IntFG
*Clash >> MapGM (Ft) >> IntFG |
| b. Clash Configuration | IntFG >> MapGM (Ft) >> *Clash
MapGM (Ft) >> IntFG >> *Clash |
| c. Stressless Foot | IntFG >> *Clash >> MapGM (Ft)
*Clash >> IntFG >> MapGM (Ft) |

The gridmark sharing configuration of the trochaic minimal alternation pattern emerges under the two rankings in (82a) where both *Clash and MapGM (Ft) rank above IntFG. The clash configuration of the trochaic double downbeat pattern emerges under the two rankings in (42b) where both IntFG and MapGM (Ft) rank above *Clash. Finally, the stressless foot of the trochaic edge ternary pattern emerges under the two rankings in (42c) where IntFG and *Clash both rank above MapGM (Ft).

Before examining in more detail the role that these rankings play in obtaining the (75) patterns, we should briefly consider the possible interaction between IntFG and Hds-Left. In competitions between a candidate with a gridmark sharing configuration at the left edge, such as (83b) and a candidate where the gridmark configuration has been shifted further to the right, such as (83a), Hds-Left will prefer the gridmark sharing configuration to occur at the left edge, and IntFG will prefer that it occur further to the right:

(83) IntFG and Hds-Left



	IntFG	Hds-Left
a. $\begin{array}{cccc} & x & & x \\ \sigma & \sigma & \sigma & \sigma \dots \\ \swarrow & & \swarrow & \swarrow \end{array}$	*	** ***
b. $\begin{array}{cccc} & & x & x \\ \sigma & \sigma & \sigma & \sigma \dots \\ \swarrow & \swarrow & & \swarrow \end{array}$	**	* ***

In (83), the candidates are the initial three trochaic feet of a prosodic word. In candidate (a) the first and second feet are intersected in a gridmark sharing configuration, but in candidate (b), the second and third feet are intersected in a gridmark sharing configuration. Although

the position of the gridmark sharing configuration in the (a) candidate produces an additional Hds-Left violation, the initial non-intersected foot positions a stress on the initial syllable, making candidate (a) more acceptable to IntFG. Although the position of (b) candidate's gridmark sharing configuration leaves the its initial syllable stressless and incurs an additional IntFG violation, the position of the intersection makes candidate (b) more acceptable to Hds-Left.

The rankings of IntFG, MapGM (Ft), and *Clash, then, only produce the results demonstrated in (79-81) above if a high ranking for Hds-Left is assumed. If Hds-Left is ranked low compared to the other constraints, a pattern emerges where a gridmark sharing configuration occurs one foot away from the left edge, as in candidate (d) below. Notice, however, that the stress pattern produced by the shifted intersection of candidate (d) is identical to that produced by the stressless second foot of candidate (c). There are actually two ways to obtain the trochaic internal ternary pattern. The tableau in (84) shows how a low ranking of Hds-Left obtains this pattern. The more detailed discussion of the edge ternary pattern further below will focus on a low ranking of MapGM (Ft), as in (81) above.

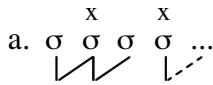
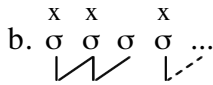
(84) IntFG, *Clash, MapGM (Ft) >> Hds-Left

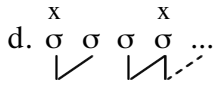
	IntFG	*Clash	MapGM (Ft)	Hds-Left
a. 	**!			* ***
b. 	*	*!		* ***
c. 	*		*!	* ***
d. 	*			** ***

In (84), the (a) candidate exhibits the trochaic minimal alternation pattern, and the (b) candidate exhibits the trochaic double downbeat pattern. The (c) candidate exhibits the edge ter-

nary pattern as obtained through use of a stressless second foot, and the (d) candidate exhibits the edge ternary pattern as obtained through use of a shifted intersection. IntFG screens out the stressless initial syllable of candidate (a), *Clash screens out the adjacent stressed syllables of candidate (b), and MapGM (Ft) screens out the stressless foot of candidate (c), leaving the shifted intersection of candidate (d) as the winner. Notice that the ranking between IntFG, *Clash, and MapGM (Ft) is not crucial. It is only crucial that each dominate Hds-Left.

4.3.2 Gridmark Sharing: Minimal Alternation

Though we have already examined minimal alternation patterns in Chapter 3, the addition of IntFG makes it appropriate at this point to briefly reconsider the trochaic version:

(85) Trochaic Minimal Alternation

a. Even-Parity

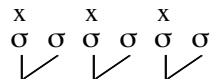

b. Odd-Parity

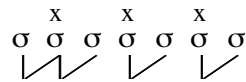

Minimal alternation patterns are considered basic to the proposed account in the sense that their odd-parity forms, illustrated in (85b), fully exploit the possibilities of improper bracketing and gridmark sharing, making them able to simultaneously exhibit the best possible foot-head alignment, avoid clash, and respect the foot-stress relationship. In other words, given the length of the form, each of the constraints in (86) agree on the (85b) pattern, as it allows each constraint to be satisfied as well as possible.

(86) Minimal Alternation Constraints

Hds-Left, MapGM (Ft), *Clash

The same is true of the even-parity configuration. Given the length of the form, each of the constraints in (86) agree on the (85a) pattern, because it allows each constraint to be satisfied as well as possible. The difference between even- and odd-parity forms is that even-parity forms do not need intersections and gridmark sharing to achieve this result.

Regardless of their ranking, each of the constraints in (86) agree on an initial stress in even-parity forms. This being the case, introducing IntFG's specific requirement that initial syllables be stressed, as in (87), cannot alter the evaluation of even-forms, and I will not focus on them in the discussion that follows.

(87) Minimal Alternation Constraints plus IntFG

Hds-Left, MapGM (Ft), *Clash, IntFG

The constraints in (86), however, do not agree on an initial stress for odd-parity forms. Since the preference of the (86) constraints is for a gridmark sharing configuration that leaves the initial syllable stressless, introducing IntFG to the constraint set does have consequences. Under a ranking of the constraints that allows IntFG's demand for initial stress to be met, the remaining constraints will not be able to exploit the gridmark sharing configuration for their mutual satisfaction, and the minimal alternation pattern will not emerge.

For minimal alternation to emerge, each of Hds-Left, *Clash, and MapGM (Ft) must rank above IntFG. As (88) demonstrates below, ranking Hds-Left over IntFG ensures that leftward foot-head alignment cannot be compromised, as in candidate (d), in order to allow stress on the initial syllable. Ranking MapGM (Ft) over IntFG ensures the foot-stress relationship will not be violated, as in candidate (c), in order to allow initial stress, and ranking *Clash over IntFG ensures that a clash configuration will not be tolerated, as in candidate (b), in order to allow initial stress.

(88) Hds-Left, MapGM (Ft), *Clash >> IntFG

	σσσσσσ	Hds-Left	MapGM	*Clash	IntFG
a.	$\begin{array}{cccccc} & & x & & x & & x \\ \sigma & \sigma & \sigma & \sigma & \sigma & \sigma & \sigma \\ \swarrow & \swarrow & \swarrow & \swarrow & \swarrow & \swarrow & \swarrow \end{array}$	<p>* ** * **</p>			**
b.	$\begin{array}{cccccc} & x & x & & x & & x \\ \sigma & \sigma & \sigma & \sigma & \sigma & \sigma & \sigma \\ \swarrow & \swarrow & \swarrow & \swarrow & \swarrow & \swarrow & \swarrow \end{array}$	<p>* ** * **</p>		*!	*
c.	$\begin{array}{cccccc} & & x & & x & & x \\ \sigma & \sigma & \sigma & \sigma & \sigma & \sigma & \sigma \\ \swarrow & \swarrow & \swarrow & \swarrow & \swarrow & \swarrow & \swarrow \end{array}$	<p>* ** * **</p>	*!		*
d.	$\begin{array}{cccccc} & x & & & x & & x \\ \sigma & \sigma & \sigma & \sigma & \sigma & \sigma & \sigma \\ \swarrow & \swarrow & \swarrow & \swarrow & \swarrow & \swarrow & \swarrow \end{array}$	<p>** ** * **</p>			*

In (88), candidate (d) drops out first. Although shifting the intersection rightward allows candidate (d) to simultaneously meet the demands of MapGM (Ft), *Clash, and IntFG, it also causes (d) to have more violations of Hds-Left than the other candidates, each of which have the best possible leftward alignment given the length of the form. The absence of a foot-level gridmark over its second foot forces candidate (c) to drop out next. The configuration allows candidate (c) to meet the demands of Hds-Left, IntFG, and *Clash, but it also causes (c) to violate MapGM (Ft) where (a) and (b) do not. Although its adjacent stressed syllables allow candidate (b) to meet the demands of Hds-Left, MapGM (Ft), and IntFG, (b) drops out as well because this same configuration incurs a violation of *Clash where (a) has none. Although the absence of a gridmark over its initial syllable causes candidate (a) to incur more violations of IntFG, it also allows (a), the minimal alternation candidate, to emerge as the winner.

The trochaic minimal alternation pattern, then, emerges when IntFG is ranked low enough in the constraint set that the demands it introduces to the grammar are suppressed. The variations on minimal alternation, however, are reactions to a highly ranked IntFG, reactions which are determined by the relative ranking of the remaining constraints.

4.3.3 Clash Configuration: Passamaquoddy

The trochaic double downbeat pattern occurs in languages like Maithili (Jha 1940-1944, 1958; see also Hayes 1995) and Passamaquoddy (LeSourd 1993; see also Green 1995 and Green and Kenstowicz 1995). Example forms from Passamaquoddy are given in (89).

(89) Passamaquoddy Forms (from Lesourd 1993)

óσ	wásis	<i>child</i>
òσσ	pèmskótek	<i>field</i>
òσσóσ	wìcohkémal	<i>he helps the other</i>
òσσóσ	wìcòhkekémo	<i>he helps out</i>
òσσóσóσ	wìcohkètahámal	<i>he thinks of helping the other</i>
òσσóσóσóσ	tèhsàhkwapàsoltíne	<i>let's walk around on top</i>

Stress in Passamaquoddy occurs on the initial syllable and on every even-numbered syllable counting from the end of the form.² For odd-parity forms, this means that stress occurs on both the initial and peninitial syllables, resulting in the characteristic clash configuration at the left edge. Primary stress is penultimate.

Although the trochaic double downbeat pattern is a reaction to a high ranking IntFG constraint, due to the compatible demands of the other relevant constraints, the effects are not observable in even-parity forms.

(90) Passamaquoddy Even-Parity Pattern

x	x	x
wi	coh	ke ta ha mal
✓	✓	✓

As discussed for the trochaic minimal alternation pattern above, IntFG, Hds-Left, MapGM (Ft), and *Clash all agree on initial stress in even-parity forms. The double downbeat pattern presents nothing new in this respect.

² Although these are not exhibited by the forms of (89), there are some complications in the stress pattern due to the occurrence of vowels that are unstressable for several apparently different reasons. I do not attempt to deal with these complications here but focus only on the basic pattern.

The effects of IntFG in the trochaic double downbeat pattern are only directly observable in odd-parity forms. In this case not all of the remaining constraints can agree with IntFG on initial stress, and initial stress is established by sacrificing the demands of *Clash. As (91) demonstrates using the seven-syllable /tèhsàhkwapàsoltíne/, ranking IntFG above *Clash ensures that the initial syllable will not be left stressless, as in candidate (b), in order to avoid clash. Ranking MapGM (Ft) above *Clash ensures that the foot-gridmark relationship will not be violated, as in candidate (c), to avoid clash, and finally, ranking Hds-Left over *Clash ensures that the intersection cannot be moved rightward, as in candidate (d), to avoid clash.

(91) Hds-Left, MapGM (Ft), IntFG >> *Clash

tehsahkwapasotine	Hds-Left	MapGM	IntFG	*Clash
x x x a.tehsah kwapa sol ti ne ✓✓ ✓ ✓	* *** * * * * *		**! *	
x x x x b.tehsah kwapa sol ti ne ✓✓ ✓ ✓	* *** * * * * *		*	*
x x x c.tehsah kwapa sol ti ne ✓✓ ✓ ✓	* *** * * * * *	*!	*	
x x x d.tehsah kwapa sol ti ne ✓ ✓✓ ✓	** *** * * * * *!		*	

Although candidate (d) performs flawlessly on MapGM (Ft) and *Clash and as well as possible on IntFG, it drops out because the position of its intersection causes it to do less well with respect to Hds-Left than the other candidates. Candidate (c) performs flawlessly on *Clash, as well as possible on IntFG, and exhibits the best possible leftward alignment for the length of the form, but it drops out because the absence of a gridmark within the domain of its second foot causes it to violate MapGM (Ft) where (a) and (b) do not. Can-

didate (b) performs flawlessly on MapGM (Ft) and *Clash and exhibits the best possible leftward alignment for the length of the form, but it drops out because the absence of a foot-level gridmark on its initial syllable causes it to have two violations of IntFG where (a) has only one. Although it violates *Clash, candidate (a) is able to do well enough on each of the higher ranked constraints to emerge as the winner. The ranking between IntFG, Hds-Left, and MapGM (Ft) is not crucial. All that matters is that each rank above *Clash.

The trochaic double downbeat pattern, then, emerges as a reaction to a high ranking IntFG constraint where the demands of IntFG are met at the expense of *Clash in odd-parity forms. This results in the characteristic adjacent stressed syllables at the left edge. In order to guarantee this configuration, however, the options of either violating the foot-stress relationship or moving the intersection rightward must be eliminated. This is accomplished by ranking MapGM (Ft) and Hds-Left above *Clash as well.

4.3.4 Stressless Second Foot: Garawa

The trochaic edge ternary pattern occurs in languages like Garawa (Furby 1974) and Indonesian (Cohn 1989, 1993; see also Cohn and McCarthy 1994 and Kenstowicz 1995). Example forms from Garawa are given in (92).

(92) Garawa Forms (from Furby 1974)³

óσ	yámi	<i>eye</i>
óσσ	púnjala	<i>white</i>
óσσσ	wátjimpànu	<i>armpit</i>
óσσσσ	kámalařìnji	<i>wrist</i>
óσσσσσ	yákalàkalàmpa	<i>loose</i>
óσσσσσσ	ŋánkìřìkìřìmpàya	<i>fought with boomerangs</i>

³ Furby makes a distinction for three levels of stress. Main stress is initial, and secondary stress is penultimate. The stresses between the initial and penultimate are described as tertiary. I will not try to account for the tertiary-secondary distinction here, but will consider all non-primary stress to be secondary.

In Garawa, stress occurs on the initial syllable and on every even-numbered syllable counting from the end of the form, except the peninitial. The lack of stress on the peninitial syllable in odd-parity forms is what creates the characteristic “initial dactyl” effect. Primary stress in Garawa is penultimate.

Although the trochaic edge ternary pattern, like the double downbeat pattern, is a reaction to a high ranking IntFG constraint, the effects of IntFG are not observable in even-parity forms:

(93) Garawa Even-Parity Pattern

^x ^x ^x
 ya ka la ka lam pa
 ✓ ✓ ✓

The reasons are the same as those presented in the discussions of minimal alternation and the double downbeat pattern above. All of the relevant constraints agree on initial stress in even-parity forms.

The “initial dactyl” effect in Garawa’s odd-parity forms results, in a sense, from moving the leftmost stress from the peninitial syllable, where it occurs in the minimal alternation pattern, to the initial syllable as in /kámalař̀nji/ and /ŋánkĩř̀ikĩř̀impàya/. Since the peninitial syllable in such forms is also the shared syllable of two intersecting feet, shifting the gridmark to the initial syllable means that the second foot no longer has a foot-level gridmark within its domain and that such forms incur a violation of MapGM (Ft). The absence of stress within the domain of the second foot— within the domain of the second and third syllables— is what creates the initial dactyl.

The effects of IntFG are directly observable in odd-parity forms, then, in the violation of MapGM (Ft). Ranking IntFG over MapGM (Ft), however, is only one of the steps necessary to obtain the desired result. To ensure that MapGM (Ft) is actually violated, competing options must be ruled out by ranking Hds-Left and *Clash over MapGM (Ft) as well. As (94) demonstrates using the seven-syllable /ŋánkĩř̀ikĩř̀impàya/, ranking IntFG

over MapGM (Ft) ensures that the initial syllable cannot remain stressless, as in candidate (b), in order to maintain the foot-stress relationship. Ranking *Clash over MapGM (Ft) ensures that a clash configuration will not be tolerated, as in candidate (c), in order to maintain the foot-stress relationship, and ranking Hds-Left over MapGM (Ft) ensures that the intersection may not move rightward, as in candidate (d), to maintain the foot-stress relationship.

(94) Hds-Left, *Clash, IntFG >> MapGM (Ft)

ηankiřikiřimpaya	Hds-Left	*Clash	IntFG	MapGM
$\begin{array}{ccccccc} & x & & x & & x & \\ a. & \eta & \text{an} & \text{ki} & \check{\text{ri}} & \text{ki} & \check{\text{ri}} \text{m pa ya} \\ & \swarrow \searrow & & \swarrow & & \swarrow & \\ & & & & & & \end{array}$	$\begin{array}{c} * \quad *** \\ ** \quad *** \end{array}$		$**!$	
$\begin{array}{ccccccc} & x & x & & x & & x \\ b. & \eta & \text{an} & \text{ki} & \check{\text{ri}} & \text{ki} & \check{\text{ri}} \text{m pa ya} \\ & \swarrow \searrow & & \swarrow & & \swarrow & \\ & & & & & & \end{array}$	$\begin{array}{c} * \quad *** \\ ** \quad *** \end{array}$	$*!$	$*$	
$\begin{array}{ccccccc} & x & & x & & x & \\ c. & \eta & \text{an} & \text{ki} & \check{\text{ri}} & \text{ki} & \check{\text{ri}} \text{m pa ya} \\ & \swarrow \searrow & & \swarrow & & \swarrow & \\ & & & & & & \end{array}$	$\begin{array}{c} * \quad *** \\ ** \quad *** \end{array}$		$*$	$*$
$\begin{array}{ccccccc} & x & & x & & x & \\ d. & \eta & \text{an} & \text{ki} & \check{\text{ri}} & \text{ki} & \check{\text{ri}} \text{m pa ya} \\ & \swarrow & & \swarrow \searrow & & \swarrow & \\ & & & & & & \end{array}$	$\begin{array}{c} ** \quad *** \\ ** \quad ***! \end{array}$		$*$	

Although it performs flawlessly on MapGM (Ft) and *Clash and as well as possible on IntFG, candidate (d) drops out because the position of its second foot causes it to perform less well on leftward foot-head alignment than the other candidates. Candidate (c) performs flawlessly on MapGM (Ft), as well as possible on IntFG, and exhibits the best possible leftward alignment for the length of the form, but it drops out because the gridmarks over its first and second syllables cause it to violate *Clash where (a) and (b) do not. Candidate (b) performs flawlessly on MapGM (Ft) and *Clash and exhibits the best possible leftward alignment for the length of the form, but it drops out because the absence of a foot-level gridmark on its initial syllable causes it to have two violations of IntFG where (a) has only

one. Although the absence of a foot-level gridmark in the domain of its second foot causes candidate (a) to violate MapGM (Ft), it also allows (a) to do better on the higher ranked constraints and, thus, to emerge as the winner. Notice that the relative rankings between IntFG, Hds-Left, and *Clash are not crucial. All that matters is that each rank above MapGM (Ft).

The trochaic edge ternary pattern of Garawa, then, is a reaction to a high ranking of the IntFG constraint where stress is established on the initial syllable of odd-parity forms at the expense of MapGM (Ft). The options of either tolerating clash or shifting the intersection rightward are ruled out by ranking *Clash and Hds-Left above MapGM (Ft) as well.

4.3.5 Predicting Asymmetries

We have seen how the proposed account produces the attested trochaic double downbeat and edge ternary patterns as variations on trochaic minimal alternation, and we turn now to an explanation of why the proposed account does not also make available the unattested iambic versions of the double downbeat and edge ternary patterns. Parallel to their trochaic counterparts, the iambic versions of the double downbeat and edge ternary patterns, illustrated with their proposed structures in (95b) and (95c) respectively, would be variations on iambic minimal alternation, illustrated in (95a).

(95) Iambic Variations

a. Minimal Alternation

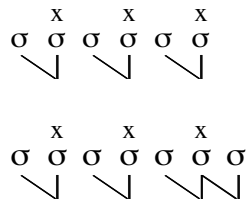

b. Double Downbeat

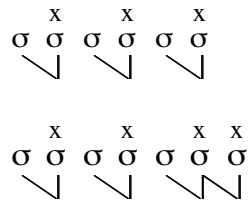

c. Edge Ternary

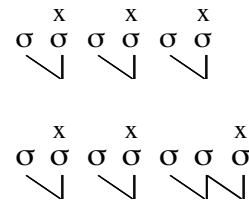

The iambic patterns exhibit the same distinguishing characteristics as their trochaic counterparts, except that the relevant configurations occur at the right edge in the iambic versions. The gridmark sharing configuration characteristic of minimal alternation occurs at the right edge in the iambic (a), the clash configuration characteristic of the double downbeat pattern

occurs at the right edge in the iambic (b), and the stressless foot characteristic of the edge ternary pattern occurs near the right edge in the iambic (c).

Although the introduction of IntFG to the constraint set allows the grammar to prefer a clash configuration or a stressless foot near the left edge of a form over what otherwise would have been the gridmark sharing configuration of trochaic minimal alternation, no constraint has been introduced that would allow the grammar to prefer a clash configuration or a stressless foot near the right edge of a form over what otherwise would be the gridmark sharing configuration of iambic minimal alternation.

In more formal terms, and as we have seen in detail above, introducing IntFG to the constraint set prevents the trochaic minimal alternation pattern from harmonically bounding the trochaic double downbeat and edge ternary patterns, but as (96) demonstrates, introducing IntFG to the constraint set does not prevent the iambic minimal alternation pattern from harmonically bounding the iambic double downbeat and edge ternary patterns.

(96) Iambic Patterns: Hds-Right, MapGM (Ft), *Clash, IntFG

$\sigma\sigma\sigma\sigma\sigma\sigma\sigma$	Hds-Right	MapGM	*Clash	IntFG
a. $\begin{array}{ccccccc} & x & & x & & x & \\ \sigma & \sigma & \sigma & \sigma & \sigma & \sigma & \sigma \\ & \diagdown & & \diagdown & & \diagdown & \diagdown \end{array}$	* ** * **			**
b. $\begin{array}{ccccccc} & x & & x & & x & x \\ \sigma & \sigma & \sigma & \sigma & \sigma & \sigma & \sigma \\ & \diagdown & & \diagdown & & \diagdown & \diagdown \end{array}$	* ** * **		*	**
c. $\begin{array}{ccccccc} & x & & x & & & x \\ \sigma & \sigma & \sigma & \sigma & \sigma & \sigma & \sigma \\ & \diagdown & & \diagdown & & \diagdown & \diagdown \end{array}$	* ** * **	*		**
d. $\begin{array}{ccccccc} & x & & x & & & x \\ \sigma & \sigma & \sigma & \sigma & \sigma & \sigma & \sigma \\ & \diagdown & & \diagdown & & \diagdown & \diagdown \end{array}$	** ** * **			**

In the tableau in (96), each of the candidates are seven-syllable forms. The (a) candidate exhibits the iambic minimal alternation pattern, the (b) candidate the iambic double downbeat pattern, and the (c) candidate the iambic edge ternary pattern. The (d) pattern represents a second way to obtain the iambic edge ternary pattern by shifting the intersection leftward.

Since candidate (a) performs as well as (b) on Hds-Right, MapGM (Ft), and IntFG and performs better than (b) on *Clash, candidate (a) harmonically bounds (b). Since candidate (a) performs as well as (c) on Hds-Right, *Clash, and IntFG and performs better than (c) on MapGM (Ft), candidate (a) harmonically bounds (c). Finally, since candidate (a) performs as well as (d) on MapGM (Ft), *Clash, and IntFG and performs better than (d) on Hds-Right, candidate (a) harmonically bounds (d). Even after the introduction of IntFG to the constraint set, then, there is no possible ranking where the (a) candidate will not emerge as the winner. The iambic minimal alternation pattern still harmonically bounds both the iambic double downbeat pattern and the iambic edge ternary pattern, and the grammar is unable to obtain either.

4.3.6 Summary

We have seen thus far that the introduction of IntFG prevents the harmonic bounding of trochaic double downbeat and edge ternary patterns by trochaic minimal alternation but does not prevent the harmonic bounding of iambic double downbeat and edge ternary patterns by iambic minimal alternation. This circumstance correctly allows the proposal to produce the trochaic versions of the edge ternary and double downbeat types without also making available their iambic mirror images. We have also examined in some detail the particular rankings that allow the individual trochaic patterns to emerge. The core parts of these rankings are summarized in (97).

(97) Summary of Rankings

- | | |
|------------------------|-----------------------------|
| a. Minimal Alternation | MapGM (Ft), *Clash >> IntFG |
| b. Double Downbeat | IntFG, MapGM (Ft) >> *Clash |
| c. Edge Ternary | IntFG, *Clash >> MapGM (Ft) |

As summarized in (97), the minimal alternation pattern results from a low ranking IntFG, the double downbeat pattern from a low ranking *Clash, and the edge ternary pattern from a low ranking MapGM (Ft).

4.3.7 Chimalapa Zoque

Other types of systems, besides the variations on trochaic minimal alternation just discussed, may also exhibit the effects of IntFG. IntFG, for example, is crucial in obtaining the stress pattern of Chimalapa Zoque (Knudson 1975), a pattern that more closely resembles unbounded systems than binary systems:

(98) Chimalapa Zoque Forms (from Knudson 1975)

óσ	mínpa	<i>he comes</i>
òóσ	hù:kú:ti	<i>fire</i>
òóóσ	mìnsukké?tpa	<i>they are coming again</i>
òóóóσ	wì:tu?payníksi	<i>he is coming and going</i>
òóóóóσ	mìnsukke?tpa?ítta	<i>they were going to come again</i>

As (98) illustrates, stress in Chimalapa Zoque occurs on the initial and penultimate syllables,⁴ with the stress on the penult being primary. All syllables between the initial and penult are stressless.

There are two primary considerations in obtaining the Chimalapa Zoque stress pattern. First, in forms with more than four syllables, one or more stressless feet will be needed to parse the string between the initial syllable and the penult, requiring an analysis similar to the one presented for unbounded stress systems in Chapter 3. Second, in forms with three syllables, stress occurs on both the first and second, requiring an analysis similar to the one presented for the trochaic double downbeat pattern above.

In producing the string of stressless syllables in longer Chimalapa Zoque forms, the analysis must maintain the correct position for primary stress. As (99) illustrates using the six-syllable /mìnsukke?tpa?ítta/, this can be accomplished by ranking both Hd-Right and MapGM (PrWd) above FG-Left. The importance of FG-Left to the ranking is, first, that it

⁴ Perturbations in the stress pattern may arise due to morphological considerations and a rule of vowel rearticulation. I focus only on the basic pattern in the discussion that follows.

produces the necessary stressless feet and, second, that it prevents the primary stress from occurring further to right than necessary by excluding candidates like (c). Ranking MapGM (PrWd) over FG-Left restricts the effects of gridmark alignment by preventing primary stress from being absent altogether, as in candidate (d), and ranking Hd-Right over FG-Left prevents movement of the primary stress leftward, as in candidate (e).

(99) Hd-Right, MapGM (PrWd), >> FG-Left

minsukke?tpa?itta	Hd-Right	MapGM (PrWd)	FG-Left
<p>a. minsukke?tpa?itta</p>			****
<p>b. minsukke?tpa?itta</p>			****
<p>c. minsukke?tpa?itta</p>			*****!
<p>d. minsukke?tpa?itta</p>		*!	
<p>e. minsukke?tpa?itta</p>	*!****		

In (99), the (e) candidate has a single stress, the primary stress, over its initial syllable. Although this configuration simultaneously satisfies FG-Left and MapGM (PrWd), candidate (e) drops out because the position of the prosodic word-head causes it to violate Hd-Right where the other candidates do not. Candidate (d) has a single secondary stress on its initial syllable and no primary stress. This configuration allows (d) to satisfy both Hd-Right and FG-Left, but it drops out because the absence of a prosodic word-level gridmark causes it to violate MapGM (PrWd) where (a-c) do not. Candidate (c) illustrates the consequences of unnecessarily violating FG-Left. Because the column constituting its primary stress occurs over the ultima rather than over the penult, candidate (c) has more violations than either (a) or (b) and drops out of contention. Candidates (a) and (b) both have primary stress on the penult, the desired position. The difference between the two candidates is that the initial syllable of (a) has a secondary stress where the initial syllable of (b) has none. This difference, however, does not allow the constraints in (99) to distinguish between them, and the decision must be passed on to other considerations.

To illustrate, the type of constraint that would promote candidate (99b) is a constraint like FG-Right, which would clearly prefer that a foot-level gridmark be absent from the initial syllable. Two options that would promote candidate (99a), the desired candidate, are IntFG and MapGM (Ft). As (100) demonstrates, both would prefer a foot-level gridmark on the initial syllable of /m^hinsukkeʔtpaʔítta/, and ranking either over FG-Right would obtain the appropriate result.

(100) IntFG, MapGM (Ft) >> FG-Right

minsukke?tpa?itta	IntFG	MapGM (Ft)	FG-Right
<p>a.min sukke?tpa ?it ta</p>	*	*	* *****
<p>b.minsukke?tpa ?it ta</p>	**! **	**!	*

To see which option is correct, it is necessary to consider the pattern in trisyllabic forms.

As (101) and (102) illustrate using the three-syllable /hù:kú:ti/, ranking IntFG >> FG-Right obtains the desired result, but ranking MapGM (Ft) >> FG-Right does not. (Note that clash avoidance is not necessarily an issue, given the weight of the initial syllable.)

(101) MapGM (Ft) >> FG-Right

hu:kú:ti	MapGM (Ft)	FG-Right
<p>a.hu:kú: ti</p>		* *!*
<p>b.hu:kú: ti</p>		*

In (101), the candidates are three-syllable prosodic words parsed by two intersecting trochees. Candidate (a) has a foot-level gridmark over the head of each foot, and candidate (b) has a single foot-level gridmark over the head of the second. Since each foot in both candi-

dates has a foot-level gridmark within its domain, MapGM (Ft) does not distinguish between the two, and the decision is passed on to FG-Right. The absence of a gridmark over the initial syllable of candidate (b) allows it to perform better with respect to FG-Right than candidate (a), and (b) incorrectly emerges as the winner.

(102) IntFG >> FG-Right

hu:ku:ti	IntFG	FG-Right
	*	* **
	**!	*

In (102), the candidates are the same as in (101) above, but IntFG has been substituted for MapGM (Ft). IntFG screens out candidate (b) because the absence of a gridmark over its initial syllable causes candidate (b) to violate IntFG more times than (a). Since FG-Right does not have a chance to influence the outcome, candidate (a) correctly emerges as the winner.

Although MapGM (Ft) would be sufficient, then, for choosing the correct pattern from the longer candidates of (100), MapGM (Ft) is not sufficient for choosing the correct pattern from the trisyllabic candidates of (101, 102). IntFG, however, makes the correct predictions in both cases.

In addition to its prominent role in obtaining the trochaic versions of double down-beat and edge ternary patterns, we have seen that IntFG plays a less obvious role in obtaining the stress pattern of Chimalapa Zoque. In combining the rankings of (99) and (102) it is crucial that FG-Right rank below FG-Left so that main stress remains on the penult rather than moving to the ultima. A final ranking like that in (103), then, produces the desired results.

(103) Final Chimalapa Zoque Ranking

Hd-Right, MapGM (PrWd), IntFG >> FG-Left >> FG-Right

Note that it is not crucial that IntFG rank above FG-Left, as in (103). It is only crucial that IntFG be ranked above FG-Right.

4.4 Window Constraints

Window constraints, which specify alignment relationships between slope categories and their associated gridmarks, are symmetrical in that they may refer to either ascent categories or descent categories:

(104) Left Window Constraints

Align (PCat1-DC(PCat2), L, PCat3-GM, R): the left edge of every PCat1 descent category in the domain of PCat2 is aligned with the right edge of its PCat3-level gridmark.

(105) Right Window Constraints

Align (PCat1-AC(PCat2), R, PCat3-GM, L): the right edge of every PCat1 ascent category in the domain of PCat2 is aligned with the left edge of its PCat3-level gridmark.

Left Window constraints, given a general definition in (104), align the right edge of every appropriate ascent category with the left edge of its associated gridmark, and Right Window constraints, given a general definition in (105), align the left edge of every appropriate descent category with the right edge of its associated gridmark.

In other words, Left Window constraints specify alignment relations between gridmarks and prosodic categories to their left, and Right Window constraints specify alignment relations between gridmarks and prosodic categories to their right. Notice, however, that Window constraints differ from the alignment constraints examined previously in two ways. First, since the existence of a slope category entails the existence of an appropriate gridmark, gridmarks are not optional in this context and may be existentially quantified under the principle outlined in Chapter 3. The existence of a gridmark, however, does not entail the existence of a slope category (the gridmark may be too near the relevant edge of the do-

main) meaning that slope categories are still optional and may not be existentially quantified.

Second, Window constraints have some directionality built in other than alignment's left-right directional specifications. By definition, ascent categories occur to the left of their associated gridmarks, and descent categories occur to the right of their associated gridmarks. This means that some of the possible directional combinations for alignment constraints would be meaningless in this case. For example, the left edge of a descent category could not be aligned with the left edge of its associated gridmark, as in (106a), because the gridmark would then be inside the category and it would not actually be a descent category.

(106) Meaningless Directional Combinations

$$\text{a. } \left(\begin{array}{c} \text{x} \\ \text{ } \end{array} \right)_{\text{DC}} \quad \text{b. } \left(\begin{array}{c} \text{ } \\ \text{x} \end{array} \right)_{\text{DC}}$$

Also, for example, the right edge of a descent category could not be aligned with the left edge of its associated gridmark, as in (106b), because the category would then be to the left of the gridmark and not actually a descent category.

Although the influence of alignment's left-right directional specifications are limited by the inherent directional nature of ascent categories and descent categories, we shall see below that this influence is not entirely eliminated. Most importantly, we will see that the effects of alignment's preference for a minimal amount of structure remain in full force.

4.4.1 Window Constraints in the Prosodic Word Domain

The first Window constraints that we will consider are alignment relationships between podal slope categories and prosodic word-level gridmarks within the domain of a prosodic word:

(107) Window Constraints in the Prosodic Word Domain

RWin or Align (Ft-DC(PrWd), L, PrWd-GM, R): the left edge of every podal descent category within the domain of the prosodic word is aligned with the right edge of its PrWd-level gridmark.

LWin or Align (Ft-AC(PrWd), R, PrWd-GM, L): the right edge of every podal ascent category within the domain of the prosodic word is aligned with the left edge of its PrWd-level gridmark

RWin demands that the left edge of all podal descent categories of a prosodic word-level gridmark be aligned with the right edge of that prosodic word-level gridmark, and LWin demands that the right edge of all podal ascent categories of a prosodic word-level gridmark be aligned with the left edge of that prosodic word-level gridmark. For reasons that will become clearer as we proceed, I assume that violations of the (107) constraints, and Window constraints generally, are measured in terms of moraic level gridmarks.

In the discussion that follows, we will examine three effects of the RWin and LWin constraints. The first is their ability to limit primary stress to a trisyllabic window at either edge of the prosodic word. Second is their ability to influence footing directionality, and third is their ability to affect syllable weight.

4.4.2 Trisyllabic Stress Windows

When satisfied, RWin and LWin establish trisyllabic windows for primary stress at the edges of prosodic words. They do so by limiting primary stress either to the domain of a peripheral foot (the rightmost in the case of RWin and the leftmost in the case of LWin) or to the syllable adjacent to the peripheral foot. The two options are available, as (108) and (109) illustrate, because it is possible to satisfy the constraints either vacuously or non-vacuously. Primary stress can occur on either syllable within the domain of the appropriate peripheral foot, as the (a) and (b) candidates demonstrate, because its proximity to the prosodic word edge ensures that the prosodic word-level gridmark has no podal slope categories to incur violations. Primary stress can occur on the syllable adjacent to the peripheral foot, as the (c) candidates demonstrate, because this ensures that there will be only a single

podal slope category and that this single category will be appropriately aligned with the prosodic word-level gridmark. If the primary stress moves away from the edge of the peripheral foot, however, as in the (d) and (e) candidates, the resulting misalignment incurs violations of the relevant constraint.

(108) Satisfaction of RWin

	RWin
a. σ σ σ σ σ σ $\begin{array}{c} x \\ x \\ \sigma \end{array}$ \swarrow \searrow	
b. σ σ σ σ σ σ $\begin{array}{c} x \\ x \\ \sigma \end{array}$ \swarrow \searrow	
c. σ σ σ σ σ σ $\begin{array}{c} x \\ x \\ \sigma \end{array}$ \swarrow \searrow	
d. σ σ σ σ σ σ $\begin{array}{c} x \\ x \\ \sigma \end{array}$ \swarrow \searrow	*
e. σ σ σ σ σ σ $\begin{array}{c} x \\ x \\ \sigma \end{array}$ \swarrow \searrow \swarrow \searrow	**
f. σ σ σ σ σ σ $\begin{array}{c} x \\ x \\ \sigma \end{array}$ \swarrow \searrow \swarrow \searrow	* ***

In the (a) and (b) candidates of (108), the prosodic word-level gridmark occurs within the domain of the final foot, over the ultima in the case of (a) and over the penult in the case of (b), meaning that the gridmark has no podal descent categories in either candidate. Since there are no podal descent categories to incur violations, (a) and (b) both vacuously satisfy RWin. In (c), the left edge of the final foot is exactly aligned with the right edge of the pro-

sodic word-level gridmark, which occurs over the antepenult. Since there is only one podal descent category and it is appropriately aligned, (c) incurs no violations. In candidate (d), the prosodic word-level gridmark occurs on the pre-antepenult and the single podal descent category is misaligned, resulting in a single violation. As the prosodic word-level gridmark moves even further to the left in the (e) and (f) candidates, more feet must be designated as descent categories, and the number of violations multiplies.

(109) Satisfaction of LWin

	LWin
a. $\begin{array}{cccccc} & x & & & & \\ & x & & & & \\ \sigma & \sigma & \sigma & \sigma & \sigma & \sigma \\ \swarrow & \searrow & & & & \end{array}$	
b. $\begin{array}{cccccc} & & x & & & \\ & & x & & & \\ \sigma & \sigma & \sigma & \sigma & \sigma & \sigma \\ \swarrow & \searrow & & & & \end{array}$	
c. $\begin{array}{cccccc} & & & x & & \\ & & & x & & \\ \sigma & \sigma & \sigma & \sigma & \sigma & \sigma \\ \swarrow & \searrow & & & & \end{array}$	
d. $\begin{array}{cccccc} & & & & x & \\ & & & & x & \\ \sigma & \sigma & \sigma & \sigma & \sigma & \sigma \\ \swarrow & \searrow & & & & \end{array}$	*
e. $\begin{array}{cccccc} & & & & x & \\ & & & & x & \\ \sigma & \sigma & \sigma & \sigma & \sigma & \sigma \\ \swarrow & \searrow & \swarrow & \searrow & & \end{array}$	**
f. $\begin{array}{cccccc} & & & & & x \\ & & & & & x \\ \sigma & \sigma & \sigma & \sigma & \sigma & \sigma \\ \swarrow & \searrow & \swarrow & \searrow & & \end{array}$	* ***

In (109), the (a) and (b) candidates both have their prosodic word-level gridmark within the domain of the initial foot, over the initial syllable in the case of (a) and over the peninitial syllable in the case of (b). Since the gridmark has no podal ascent categories in either can-

didate, both (a) and (b) vacuously satisfy LWin. In (c), the right edge of the initial foot, the only podal ascent category, is exactly aligned with the left edge of the prosodic word-level gridmark occurring over the post-peninitial syllable, and the candidate incurs no violations. As the gridmark moves rightward from the post-peninitial syllable in the remaining candidates, violations are incurred both through misalignment with a single ascent category, as in the case of (d), and through the mandatory designation of additional ascent categories, as in the cases of (e) and (f).

In the discussion of trisyllabic windows to follow, the example languages can be analyzed essentially as unbounded stress systems constrained by a window. The core interactions, then, will be between the window constraints and gridmark alignment constraints, since gridmark alignment constraints are primarily responsible for determining the position of stress in unbounded systems. In particular, the relevant interactions will be between RWin and FG-Left and between LWin and FG-Right. Note, however, that any type of constraint capable of influencing the position of primary stress, such as IntPG or prosodic word-head alignment constraints, can be involved in similar interactions with the Window constraints.

Consider the competing preferences of RWin and FG-Left in forms with more than three syllables, the forms where windows are typically relevant. In competitions between a candidate with antepenultimate (or penultimate or ultimate) stress, such as (110a), and a candidate whose stress is further to the left, such as (110b), RWin will prefer stress on the antepenult (or penult or ultima), and FG-Left will prefer stress further to the left.

(110) RWin and FG-Left

	RWin	FG-Left
<p>a. σ σ σ σ $\overset{x}{\sigma}$ σ σ</p> <p style="margin-left: 100px;">\vee</p>		****
<p>b. $\overset{x}{\sigma}$ σ σ σ σ σ σ</p> <p style="margin-left: 20px;">\vee \vee \vee</p>	** ****	

In (110), the candidates are seven-syllable prosodic words. Stress occurs on the antepenult in the (a) candidate and on the initial syllable in the (b) candidate. Although the (a) candidate's antepenultimate stress produces several violations of FG-Left, the prosodic word-level gridmark is aligned with its only podal descent category, making it acceptable to RWin. Although the (b) candidate's prosodic word-level gridmark has several podal descent categories and several violations of RWin, the fact that the stress is initial makes it acceptable to FG-Left.

Consider also the competing preferences of LWin and FG-Right. In competitions between a candidate with stress on the post-peninitial (or peninitial or initial) syllable, such as (111a) and a candidate with stress further to the right, such as (111b), LWin will prefer the post-peninitial (or peninitial or initial) stress, and FG-Right will prefer stress further to the right.

(111) LWin and FG-Right

	LWin	FG-Right
<p>a. σ σ $\overset{x}{\sigma}$ σ σ σ σ</p> <p style="margin-left: 40px;">\swarrow</p>		****
<p>b. σ σ σ σ σ σ $\overset{x}{\sigma}$</p> <p style="margin-left: 40px;">\swarrow \swarrow \swarrow</p>	** ****	

In (111), each candidate is again a seven-syllable prosodic word. Stress occurs on the post-penultimate syllable in candidate (a) and on the final syllable in candidate (b). Because the (a) candidate's stress occurs away from the right edge, it incurs several violations of FG-Right, but because its prosodic word-level gridmark is aligned with its only ascent category, it is acceptable to LWin. Because the (b) candidate has multiple podal ascent categories, it incurs several violations of LWin, but because stress occurs on the final syllable, it is acceptable to FG-Right.

In the examples that we will examine below, establishing stress windows will mean ranking the appropriate window constraint over the relevant gridmark alignment constraint. If the gridmark alignment constraints ranked above the window constraints, the stress windows would be ignored, as in the (b) candidates of (110, 111), resulting in the types of unbounded stress systems discussed in Chapter 3.

4.4.2.1 Trisyllabic Windows at the Right Edge

Many languages— Latin, Macedonian (Comrie 1976), Polish (Comrie 1976), and Seylawarese (Mithun and Basri 1985), for example— limit primary stress to a word's final three syllables. Below, I will focus on the pattern of Macedonian, which shows the effects of a trisyllabic window both in its regular antepenultimate stress and in the limitations placed

on irregular stress. The differences between the regular pattern and the irregular pattern are illustrated in their reactions to suffixation:

(112) Macedonian Forms (from Comrie 1976)

a. Regular Stress Pattern

zbór	<i>word</i>	vodéničar	<i>miller</i>
zbórot		vodeničarot	
zbórovi		vodeničari	
zboróvite		vodeničárite	

b. Irregular Stress Pattern

citát	<i>quotation</i>	romántik	<i>romantic</i>
citátot		romántikot	
citáti		romántici	
citátite		romantícite	

In the regular pattern in (112a), stress occurs on the antepenultimate syllable if there is one, otherwise on the initial syllable. This will be the case regardless of the number of suffixes occurring with the form. In the irregular patterns in (112b), stress is associated with a particular syllable, the penultimate man in romántik, for example, or the ultimate tat in citát. Stress remains with this particular syllable under suffixation— if suffixation does not push it further to the left than the antepenult. If suffixation would push stress further to the left than the antepenult, then stress will occur on the antepenult by default, as in the regular pattern.

There are three steps in the analysis of the Macedonian patterns. The first is to establish a trisyllabic window at the right edge and regular antepenultimate stress. The second is to provide for irregular stress, and the third is to subject irregular stress to the limitations of the trisyllabic window. As demonstrated with vodéničar in (113), the first step is accomplished using RWin to establish the stress window, MapGM (PrWd) to ensure a primary stress, and FG-Left to push the gridmark column as far to left as possible within the stress window. Ranking MapGM (PrWd) over FG-Left prevents the prosodic word-level gridmark from being absent, as in candidate (e), in an effort to promote better leftward

gridmark alignment, and ranking RWin over FG-Left prevents the prosodic word-level gridmark from occurring further to the left than the antepenult, as in candidate (d), in an effort to promote better leftward gridmark alignment. Finally, even with its low ranking, FG-Left is still able to prevent stress from occurring further to the right than necessary, as in candidates (b, c).

(113) MapGM (PrWd), RWin >> FG-Left

vodeničar	MapGM (PrWd)	RWin	FG-Left
$\begin{array}{c} x \\ x \\ \text{a. vo de ni } \check{\text{c}}\text{ar} \\ \quad \quad \quad \vee \end{array}$			*
$\begin{array}{c} x \\ x \\ \text{b. vo de ni } \check{\text{c}}\text{ar} \\ \quad \quad \quad \vee \end{array}$			**!
$\begin{array}{c} x \\ x \\ \text{c. vo de ni } \check{\text{c}}\text{ar} \\ \quad \quad \quad \vee \end{array}$			**!*
$\begin{array}{c} x \\ x \\ \text{d. vo de ni } \check{\text{c}}\text{ar} \\ \quad \quad \quad \vee \end{array}$		*!	
$\begin{array}{c} x \\ \text{e. vo de ni } \check{\text{c}}\text{ar} \\ \quad \quad \quad \vee \end{array}$	*!		

In (113), each candidate is a four-syllable prosodic word. First, MapGM (PrWd) and RWin screen out candidates (d) and (e). MapGM (PrWd) screens out the (e) candidate because it lacks a prosodic word-level gridmark, and RWin screens out the initial stress of the (d) candidate, because its prosodic word-level gridmark is neither aligned with the final foot nor within the final foot. The decision between (a-c) is passed on to FG-Left. FG-Left screens

out stress on the ultima in candidate (c) and on the penult in candidate (b), leaving the desired antepenultimate stress of candidate (a) as the winner.

Although the ranking in (113) correctly predicts the regular pattern of (112a), it does not account for the irregular patterns of (112b). In obtaining these patterns, I will assume that irregular stress is specified underlyingly, allowing it to be the object of an Input-Output Faithfulness constraint that maintains its underlying position. If this Faithfulness constraint ranks above FG-Left, as demonstrated using *romántik* in (114), stress will remain on the penult (or ultima) rather than being forced further to the left.

(114) Faith >> FG-Left

romántik	Faith	FG-Left
x x a. romantik ∨ x x b. romantik ∨	*!	*

In (114), both candidates are three-syllable forms, with stress occurring on the penult in candidate (a) and on the antepenult in candidate (b). Although positioning stress on its antepenult allows (b) to satisfy FG-Left, it also causes (b) to violate the higher ranked Faithfulness constraint because the gridmark column does not occur over the syllable it was associated with in the underlying form. The position of the gridmark column in candidate (a) causes it to violate FG-Left, but it also allows (a) to be faithful to the underlying form. Since Faith is the higher ranked constraint, candidate (a) emerges as the winner.

Having provided for the occurrence of irregular stress, the final step is restricting irregular stress to the trisyllabic window at the right edge of the prosodic word. As (115) demonstrates using *románticite*, this means ranking RWin over Faith so that stress cannot

be pushed further to the left than the antepenult, as in candidate (b), in an effort to be faithful to the underlying form.

(115) RWin >> Faith

románticite	RWin	Faith
a. roman ti cit e x x ∨		*
b. roman ti cit e x x ∨	*!	

In (115), both candidates have five syllables, with stress occurring on the antepenult in candidate (a) and on the pre-antepenult in candidate (b). The position of its gridmark column allows (b) to be faithful to the underlying form, but it also means that the prosodic word-level gridmark is neither aligned with the final foot nor within the final foot. Since the gridmark column occurs outside the trisyllabic window, (b) violates RWin. The position of the gridmark column in candidate (a) causes (a) to violate the faithfulness constraint, but it also allows the single descent category to be appropriately aligned with the prosodic word-level gridmark. Since its gridmark column occurs within the trisyllabic window and since RWin is the higher ranked constraint, candidate (a) correctly emerges as the winner.

The effects of a high ranking RWin constraint, then, account both for Macedonian's regular antepenultimate stress and for the restriction of irregular stress to the final three syllables. Regular antepenultimate stress is obtained by ranking MapGM (PrWd) and RWin over FG-Left, and irregular stress is respected by ranking Faith over FG-Left. The restriction on irregular stress is obtained by ranking RWin over Faith, giving the final ranking MapGM (PrWd), RWin >> Faith >> FG-Left.

4.4.2.2 Trisyllabic Windows at the Left Edge

Trisyllabic stress windows at the left edge of a form are typically taken to be unattested. A recent account by Hualde (1998), however, argues for just such a restriction in the stress pattern of Azkoitia Basque:

(116) Azkoitia Basque Forms (from Hualde 1998)

óσ	óna	<i>good</i>
σóσ	gizóna	<i>man</i>
σσóσ	katedrála	<i>cathedral</i>
σσóσσ	melokótoye	<i>peach</i>
σσóσσσ	telebísixue	<i>television</i>

In Azkoitia, stress occurs on the post-peninitial syllable in forms with more than three syllables and on the rightmost non-final syllable in forms with three syllables or fewer.

To account for this pattern we can say that stress is aligned as far to the right as possible but that rightward gridmark alignment is restricted both by syllabic NonFinality within the prosodic word and by a trisyllabic stress window at the prosodic word's left edge. The NonFinality restriction is most relevant in forms with three syllables or fewer, since the stress window is not active in restricting stress in such forms. In other words, in forms with three or fewer syllables, the failure of stress to occur on the rightmost syllable cannot be attributed to the stress window.

To account for such forms, it is necessary to rank MapGM (PrWd) and SNonFinality above FG-Right. Notice that this is the same ranking used in the analysis of Yawelmani above. As (117) demonstrates using *gizóna*, ranking MapGM (PrWd) above FG-Right prevents the form from being stressless, as in candidate (d), in an effort to satisfy FG-Right vacuously, and ranking SNonFinality over FG-Right prevents stress from occurring over the final syllable, as in candidate (c), in an effort to satisfy FG-Right non-vacuously. Finally, even given its low ranking, FG-Right has enough influence to prevent

stress from occurring further to the left than necessary for avoidance of the final syllable, as in candidate (b).

(117) MapGM (PrWd), SNonFinality >> FG-Right

gizona	MapGM (PrWd)	SNonFinality	FG-Right
a. $\begin{array}{c} x \\ x \\ \text{gi zo na} \\ \vee \end{array}$			*
b. $\begin{array}{c} x \\ x \\ \text{gi zo na} \\ \vee \end{array}$			**!
c. $\begin{array}{c} x \\ x \\ \text{gi zo na} \\ \vee \end{array}$		*!	
d. $\begin{array}{c} \text{gi zo na} \\ \vee \end{array}$	*!		

In (117), each candidate is a three-syllable form, the difference between them being that primary stress occurs on the penult in candidate (a), on the antepenult in candidate (b), and on the ultima in candidate (c). Candidate (d) is stressless. MapGM (PrWd) and SNonFinality screen out candidates (c) and (d). MapGM (PrWd) screens out the absence of stress in the (d) candidate, and SNonFinality screens out the final stress of the (c) candidate. The decision between (a) and (b) is passed on to FG-Right. FG-Right screens out the initial stress of candidate (b), leaving the penultimate stress of candidate (a) as the winner.

In forms with more than three syllables, the stress window imposed by LWin is most relevant in restricting the position of primary stress. As (118) demonstrates using melokótoye, ranking LWin over FG-Right prevents stress from moving beyond the first three syllables, as in candidate (d), in an effort to achieve better rightward alignment. FG-

Right, however, still has enough influence to prevent stress from occurring further to the left than necessary within the trisyllabic window, as in candidates (b) and (c).

(118) MapGM (PrWd), LWin >> FG-Right

melokotoye	MapGM (PrWd)	LWin	FG-Right
$\begin{array}{c} \text{x} \\ \text{x} \\ \text{a.me lo ko to ye} \\ \vee \end{array}$			**
$\begin{array}{c} \text{x} \\ \text{x} \\ \text{b.me lo ko to ye} \\ \vee \end{array}$			***!
$\begin{array}{c} \text{x} \\ \text{x} \\ \text{c.me lo ko to ye} \\ \vee \end{array}$			***!*
$\begin{array}{c} \text{x} \\ \text{x} \\ \text{d.me lo ko to ye} \\ \vee \end{array}$		*!	*
$\begin{array}{c} \text{x} \\ \text{e.me lo ko to ye} \\ \vee \end{array}$	*!		*

In (118), each of the candidates is a five-syllable form, the difference between them being the location of primary stress. MapGM (PrWd) performs a function here similar to its function in the preceding tableau. It screens out the stress on the fourth syllable of the (e) candidate because it lacks a prosodic word-level gridmark. LWin screens out the stress on the fourth syllable of candidate (d), since the prosodic word-level gridmark is neither aligned with the initial foot nor within the initial foot. The decision between (a-c) is passed on to FG-Right. FG-Right screens out the initial stress of candidate (c) and the peninitial stress of candidate (b), leaving the post-peninitial stress of candidate (a) as the winner.

A high ranking LWin constraint, then, creates a trisyllabic window for primary stress at the left edge of a prosodic word. This, in conjunction with the effects of SNonFinality, produces the desired pattern for Azkoitia Basque.

4.4.3 Influencing Footing Directionality

In trisyllabic windows such as those just discussed, the position of primary stress is somewhat flexible and can be limited to the area defined by the stress window. This, of course, is due to the rankings involved. Since a Window constraint, either RWin or LWin, ranks above other constraints that might affect the position of primary stress, primary stress is limited to the trisyllabic window. In situations, however, where the position of primary stress is less flexible— where the ranking fixes primary stress outside of a stress window— window constraints may still have a substantial impact on the shape of the output.

For example, given a primary stress fixed on the initial syllable, the degree of satisfaction of RWin depends on the position of the feet within the prosodic word. Since all but the initial foot will be descent categories, the better a candidate's feet are aligned with the primary stress, the better that candidate will perform:

(119) RWin with Fixed Primary Stress

	RWin
x x a. σ σ σ σ σ σ 	** *****
x x b. σ σ σ σ σ σ 	* ** *****
x x c. σ σ σ σ σ σ 	* ***** *****

In (119), each of the candidates are seven-syllable prosodic words with an initial primary stress. The best satisfaction of RWin occurs in candidate (a), where the intersecting feet occur near the left edge of the prosodic word, as this allows the feet (all but the first of which are descent categories) to be better aligned with the initial stress. As the intersecting feet move away from the left edge of the prosodic word in candidates (b) and (c), they also move away from the initial stress. This produces additional violations of RWin.

The stress pattern of Cahuilla (Seiler 1965, 1967, 1977 and Seiler and Hioki 1979) offers an example of how window constraints can be put to use in the manner just discussed. As illustrated in (120), Cahuilla's basic pattern is that of trochaic maximal alternation.

(120) Cahuilla Forms (from Hayes 1995)

́LL̀	táxmuʔàt	<i>song</i>
́LL̀L̀	tákaličem	<i>one-eyed ones</i>
́LL̀L̀L̀	(pàpen) túleqàlevèh	<i>where I was grinding it</i>

In forms with only light syllables, stress occurs on every odd-numbered syllable, with the initial stress also being the primary stress. The presence of heavy syllables, however, as we shall see below and in fuller detail in Chapter 5, can perturb this basic pattern.

In Chapter 3, we obtained the trochaic maximal alternation pattern by aligning the left edge of the prosodic word with a foot-head and aligning all remaining foot-heads to the right. This approach cannot, however, be used to obtain the maximal alternation pattern of Cahuilla, which as (121) illustrates, appears to be produced by clash avoidance rather than rightward foot-head alignment.

(121) Directionality Problem

a.	́LL̀	táxmuʔàt	<i>song</i>
b.	́HL̀L̀	háʔtìsqal	<i>he is sneezing</i>

Example (121) compares two three-syllable forms. The first /táxmuʔàt/ has only light syllables with stress on the first and third. The second /háʔtìsqal/ has an initial heavy syl-

lable and stress on the first and second. This indicates that when clash is not an issue, as in (b), foot-heads prefer to occur as far to the left as possible, but when clash is an issue, as in (a), foot-heads are shifted to the right.

The particular problem for the proposed account is in longer forms, where clash avoidance need not cause a general shift in foot-heads. As illustrated using a seven-syllable form in (122a), if the second foot shifts rightward to form an intersection with the third, merely shifting the second foot-head rightward as well creates a gridmark sharing configuration, allowing the form to avoid clash and eliminating the need for further rightward movement of foot-heads.

(122) Clash Avoidance Options



What is needed is a way to fix the position of the second foot, as in (122b), so that clash avoidance necessitates shifting all but the initial foot-head to the right. This cannot be accomplished through foot-head alignment, the primary mechanism for determining footing directionality to this point. Once the second foot-head has shifted, it does not matter to foot-head alignment whether the second foot includes the second and third syllables or the third and fourth.

Although feet cannot be aligned directly in the proposed account, they can be aligned indirectly by Window constraints through their designation as slope categories. All that is required is that the position of primary stress be fixed independently of the Window constraint. As demonstrated in (123), ranking IntPG over RWin fixes primary stress over the initial syllable. Although the initial syllable falls outside the trisyllabic window established by RWin at the right edge of the prosodic word, this does not mean that the demands of RWin are without influence. Podal descent categories still prefer to be as near as possible to the primary stress.

(123) IntPG >> RWin

	IntPG	RWin
<p>a. $\begin{array}{ccccccc} & x & & & & & \\ & x & & & & & \\ \sigma & \sigma & \sigma & \sigma & \sigma & \sigma & \sigma \\ & \swarrow & \searrow & & \swarrow & \searrow & \\ & & & & & & \end{array}$</p>	*	** *****
<p>b. $\begin{array}{ccccccc} & x & & & & & \\ & x & & & & & \\ \sigma & \sigma & \sigma & \sigma & \sigma & \sigma & \sigma \\ & \swarrow & & \swarrow & \searrow & & \swarrow & \searrow \\ & & & & & & & \end{array}$</p>	*	* ** *****!
<p>c. $\begin{array}{ccccccc} & & & & x & & \\ & & & & x & & \\ \sigma & \sigma & \sigma & \sigma & \sigma & \sigma & \sigma \\ & & & & & \swarrow & \searrow \\ & & & & & & \end{array}$</p>	*!*****	

In (123), candidate (c) conforms to the trisyllabic window established by RWin but is forced to drop out because, in doing so, it violates IntPG more than either (a) or (b). Because (a) and (b) both have initial primary stress and satisfy IntPG as well as possible, the decision between them is passed on to RWin. Here, the position of the intersection at the prosodic word's left edge in candidate (a) allows the descent categories to be nearer the primary stress than the position of intersection one foot removed from the left edge in candidate (b). Since (a) incurs fewer violations of RWin, it emerges as the winner.

Since primary stress is fixed on the initial syllable in Cahuilla, RWin can be utilized to establish the appropriate footing directionality independently of foot-head alignment. To obtain the desired pattern, however, as (124) demonstrates using the five-syllable /túleq̀d̀levèh/, the demands of Hds-Left must be circumscribed by both RWin and *Clash. Ranking RWin over Hds-Left ensures that the second foot cannot shift rightward, as in candidate (b), in order to promote better leftward foot-head alignment, and ranking *Clash over Hds-Left ensures that there can be no clash configuration at the left edge of the form, as in candidate (c), in order to promote better leftward foot-head alignment. (Only candidates which satisfy IntPG and MapGM (Ft) are considered.)

(124) *Clash, RWin >> Hds-Left

tuleqaleveh	*Clash	RWin	Hds-Left
$\begin{array}{c} x \\ x \quad x \quad x \\ \text{a. tu le qa le veh} \\ \swarrow \quad \searrow \quad \swarrow \end{array}$		* ***	** ****
$\begin{array}{c} x \\ x \quad \quad x \\ \text{b. tu le qa le veh} \\ \swarrow \quad \swarrow \quad \swarrow \end{array}$		** ****!	** ***
$\begin{array}{c} x \\ x \quad x \quad x \\ \text{c. tu le qa le veh} \\ \swarrow \quad \swarrow \quad \swarrow \end{array}$	*!	* ***	* ***

In (124), each candidate consists of five light syllables. Candidate (c) drops out first. Although stressing its second syllable allows (c) to satisfy Hds-Left as well as possible given the length of the form and to satisfy RWin as well as possible given the position of the prosodic word-level gridmark, it also causes (c) to violate *Clash where (a) and (b) do not. Candidate (b) drops out next. The position of its second foot promotes a gridmark sharing configuration and allows (b) to avoid clash with minimal compromise of leftward foot-head alignment, but it also causes (b) to incur more violations of RWin than (a). Although the positions of its second and third foot-heads cause (a) to incur additional violations of Hds-Left, they also allow (a) to perform well enough on the higher ranked constraints to emerge as the winner.

In obtaining the trochaic maximal alternation pattern with the ranking in (124), we are also able to obtain the correct prediction for /háʔtìsqal/. Since the initial syllable of /háʔtìsqal/ is heavy, it is possible to have leftward foot-head alignment without violating either IntPG or *Clash and without incurring additional violations of RWin. (Only candidates which satisfy IntPG and MapGM (Ft) are considered.)

(125) *Clash, RWin >> Hds-Left

haʔtisqal	*Clash	RWin	Hds-Left
		*	*
		*	**!

In (125), both candidates are three-syllable forms with an initial heavy syllable. Candidate (a) exhibits leftward foot-head alignment, and candidate (b) exhibits the maximal alternation pattern. Both candidates have an intervening mora-level gridmark between foot-level gridmarks, satisfying *Clash, and both perform as well as possible on RWin given the position of the prosodic word-level gridmark. Since the higher ranked constraints do not distinguish between them, the decision between the two is passed on to Hds-Left. Here, candidate (a) correctly emerges as the winner because the position of its second foot-head allows it to have better leftward alignment than candidate (b).

We have seen in the discussion thus far that Window constraints may not only limit the position of primary stress but they may also influence footing directionality when the position of primary stress is fixed. Next, we will examine how Window constraints can influence syllable weight.

4.4.4 Influencing Syllable Weight

Because violations of Window constraints are measured in terms of mora-level gridmarks, Window constraints are sensitive to both syllable weight and gridmark mapping. Recall that there are two ways to satisfy RWin and LWin. The prosodic word-level gridmark must either occur within the appropriate peripheral foot, or it must be aligned with the appropriate peripheral foot. Measurement of violations in terms of mora-level gridmarks means that misalignment occurs when one or more mora-level gridmarks intervenes between the prosodic word-level gridmark and the appropriate peripheral foot. Assuming, then, that the head mora of a heavy syllable is typically its initial mora, RWin, for example, will tolerate primary stress over the syllable adjacent to the rightmost foot if the syllable is either light, as in (126a), or heavy and monopositionally mapped, as in (126b), but not if the antepenult is heavy and bimensionally mapped, as in (126c).

(126) Satisfaction of RWin

	RWin
<p>a.</p> <pre> x x x x x μ μ μ σ σ σ \ / </pre>	
<p>b.</p> <pre> x x x x x μ μ μ μ \ / σ σ σ \ / </pre>	
<p>c.</p> <pre> x x x x x x μ μ μ μ \ / σ σ σ \ / </pre>	*

In (126), each candidate is a three-syllable prosodic word, with primary stress on the antepenult and a single podal descent category. In the (a) candidate, where the antepenult is light, there is no mora-level gridmark between the descent category and the prosodic word-level gridmark. In candidate (b), where the antepenult is heavy but monopositionally mapped, there is still no intervening mora-level gridmark. In candidate (c), however, where the antepenult is heavy and bimensionally mapped, the gridmark of the non-head mora intervenes between the descent category and the prosodic word-level gridmark. Candidate (a) and (b), then, satisfy RWin, but (c) does not.

The consequences of sensitivity to syllable weight and gridmark mapping can most easily be seen when an underlyingly heavy antepenult must be stressed on the surface. If RWin is to be satisfied through alignment of the prosodic word-level gridmark with the rightmost foot, then the antepenult must either be shortened, as in (126a) above, or monopositionally mapped, as in (126b). The former option is utilized in the phenomena of trisyllabic shortening in English, to be discussed below, and the latter option is important in predicting the position of stress in Latin, to be discussed in Chapter 5.

Whether an underlyingly heavy antepenult is shortened, monopositionally mapped, or in violation of the stress window depends on the interactions between RWin, MapGM (Mora), and Max. Recall that MapGM (Mora) is the constraint that requires moras to be associated with moraic level gridmarks, and Max is the constraint prohibiting input material from being deleted in the output. The treatment of the heavy syllable depends on which one of the three constraints is lowest ranked. As (127) demonstrates, a heavy antepenult will be stressed and bimensionally mapped, violating the stress window, when Max and MapGM (Mora) rank above RWin.

(127) Max, MapGM (Mora) >> RWin

HLL	Max	MapGM (Mora)	RWin
<p>a.</p>			*
<p>b.</p>		*!	
<p>c.</p>	*!		

In (127), each of the candidates are three-syllable prosodic words with stress on the antepenult. The antepenult of candidate (a) is heavy and bimensionally mapped, the antepenult of candidate (b) is heavy and monimensionally mapped, and the antepenult of candidate (c) is light. Max screens out the light antepenult of candidate (c) since it has lost a mora from the input form. MapGM (Mora) screens out the monimensionally mapped antepenult of candidate (b) since it has a mora without a gridmark. This leaves the bimensionally mapped antepenult of candidate (a) as the winner, and RWin is unable to influence the outcome. Notice that the ranking between Max and MapGM (Mora) is not crucial.

Consider next the emergence of a heavy monimensionally mapped antepenult when Max and RWin rank above MapGM (Mora):

(128) Max, RWin >> MapGM (Mora)

HLL	Max	RWin	MapGM (Mora)
<p>a.</p> <pre> x x x x x x μ μ μ μ σ σ σ \ V </pre>		*!	
<p>b.</p> <pre> x x x x x μ μ μ σ σ σ \ V </pre>			*
<p>c.</p> <pre> x x x x x μ μ μ σ σ σ \ V </pre>	*!		

In (128), the candidate are the same as in (127) above. Under the (128) ranking, however, RWin screens out the bipositionally mapped antepenult of candidate (a) since there is a mora-level gridmark separating primary stress from the rightmost foot. Max screens out the light antepenult of candidate (c), and the monopositionally mapped penult of candidate (b) is the winner. Given its low ranking, MapGM (Mora) does not have a chance to influence the outcome. Again, the ranking of the two higher constraints is not crucial.

Finally, consider in (129) the emergence of a light antepenult when MapGM (Mora) and RWin rank over Max. This is the ranking most relevant to the discussion of trisyllabic shortening below.

(129) MapGM (Mora), RWin >> Max

HLL	MapGM (Mora)	RWin	Max
<p>a.</p> <pre> x x x x x x μ μ μ μ σ σ σ \ / </pre>		*!	
<p>b.</p> <pre> x x x x x μ μ μ μ σ σ σ \ / </pre>	*!		
<p>c.</p> <pre> x x x x x μ μ μ σ σ σ \ / </pre>			*

In (129), the candidates are the same as in (127) and (128) above. Under this ranking, MapGM (Mora) screens out the monopositionally mapped antepenult of candidate (b) and RWin screens out the bipositionally mapped antepenult of candidate (a). This leaves the light antepenult of candidate (c) as the winner. The ranking between MapGM (Mora) and RWin is not crucial, and, given its low ranking, Max does not have a chance to influence the outcome.

In the well-known phenomenon of trisyllabic shortening, illustrated by the pairs in (130), primary stress occurs over an underlyingly long vowel or a diphthong.

(130) Trisyllabic Shortening in English

sə'ri:n sə'reniti
prof'e:n prof'æniti
sé:n sæniti
ó:mən ómənəs

The vowel retains its length in forms where it occurs in the penult or ultima, as in the first column of (130), but it is shortened in related forms where it occurs in the antepenult, as in the second column of (130). Such shortening is typically accompanied by a shift in vowel quality or monophthongization, a circumstance that I will set aside here.

There are two steps in producing the shortening exhibited in the second column. The first is to establish a trisyllabic window at the right edge of the prosodic word. This is accomplished with a high ranking RWin constraint. The second is to establish the appropriate reaction to the window when a stressed antepenult is underlyingly heavy. Since the appropriate reaction is shortening, RWin and MapGM (Mora) must both rank over Max, as in (129) above. As (131) demonstrates using [səréni^ˈti], ranking RWin over Max prevents the stress window from being ignored, as in candidate (c), in an effort to avoid shortening. Ranking MapGM (Mora) over Max prevents the non-head mora of the antepenult form going without a gridmark, as in candidate (b), in order to avoid shortening.

(131) Shortening: MapGM (Mora), RWin >> Max

səˈrɛnɪti	RWin	MapGM (Mora)	Max
<p>a. sə rɛ nɪ ti</p>			*
<p>b. sə ri nɪ ti</p>		*!	
<p>c. sə ri nɪ ti</p>	*!		

In (131), each candidate is a four-syllable prosodic word with primary stress on the antepenult and a single podal descent category. RWin and MapGM (Mora) screen out the heavy antepenults of candidates (b) and (c). RWin screens out the bipositionally mapped heavy syllable of the (c) candidate, and MapGM (Mora) screens out the monopositionally mapped heavy syllable of the (b) candidate. This leaves the shortened syllable of candidate (a) as the winner. Given its low ranking, Max does not have a chance to influence the outcome.

Notice that this ranking also makes the correct prediction for the corresponding form [səˈrɛ:n] from the first column of (130). Since the stressed syllable is the ultima and occurs within the rightmost foot, there is no need to shorten it for the purpose of alignment:

(132) No Shortening: RWin, MapGM (Mora) >> Max

səri:n	RWin	MapGM (Mora)	Max
<p>a. sə rɛn</p>			*!
<p>b. sə rin</p>		*!	
<p>c. sə rin</p>			

In (132), each of the candidates is a two-syllable prosodic word with primary stress on the ultima. Since there are no podal descent categories in any of the candidates, RWin has no influence on the evaluation. MapGM (Mora) screens out the heavy monopositionally mapped ultima of candidate (b), and Max screens out the shortened ultima of candidate (a). This leaves the bipositionally mapped heavy syllable of candidate (c), which violates none of the constraints, as the winner.

We have seen, then, that there are several uses for Window constraints. The podal constraints discussed above can be used to establish trisyllabic stress windows, to influence footing directionality, and to influence syllable weight and gridmark mapping. We will see additional uses for Window constraints in Chapter 5.

4.5 Summary

In this chapter, I have introduced a fourth system, the Slope Category System, to the grammar. The Slope Category System is defined in terms of two other systems, the Metrical Grid and the Prosodic Hierarchy, with slope categories being specially designated prosodic categories that occur between a gridmark and the edge of some larger domain. I introduced three types of constraints either based on this system or reformulated in terms of this system: NonFinality constraints, Initial Gridmark constraints, and Window constraints. The particular constraints discussed in this chapter are repeated in (133-135).

(133) Syllabic NonFinality Constraints

SNonFinality or NonFin (Ft-GM, Syll, PrWd): Every foot-level gridmark has a syllabic descent category within the domain of the prosodic word.

Trochee or NonFin (Ft-GM, Syll, Ft): Every foot-level gridmark has a syllabic descent category within the domain of the foot.

(134) Initial Gridmark Constraints

IntFG or IntGrid (Syll, Ft-GM): Every syllable is a descent category for some foot-level gridmark in some domain.

IntPG or IntGrid (Syll, PrWd-GM): Every syllable is a descent category for some PrWd-level gridmark in some domain.

(135) Window Constraints in the Prosodic Word Domain

RWin or Align (Ft-DC(PrWd), L, PrWd-GM, R): the left edge of every podal descent category within the domain of the prosodic word is aligned with the right edge of its PrWd-level gridmark.

LWin or Align (Ft-AC(PrWd), R, PrWd-GM, L): the right edge of every podal ascent category within the domain of the prosodic word is aligned with the left edge of its PrWd-level gridmark

NonFinality constraints insisted on a minimal distance between gridmarks and the right edge of a domain and were responsible for obtaining the correct predictions concerning the asymmetrically attested double offbeat and internal ternary patterns as well as for obtaining the correct predictions concerning the asymmetrically attested even offbeat and even downbeat patterns. Initial Gridmark constraints insisted on stress at a form's left edge and were responsible for obtaining the correct predictions concerning the asymmetrically attested

double downbeat and edge ternary patterns. Finally, Window constraints insisted on a minimal distance between gridmarks and the edges of domains and were responsible for establishing trisyllabic windows for primary stress.

CHAPTER FIVE
WEIGHT-SENSITIVITY

It has long been recognized that there is a connection between syllable weight and stress. The relationship, however, can be and has been approached from two different directions. The first is from syllable weight to stress as in Prince's (1991) Weight to Stress Principle, which holds that prominence with respect to syllable weight should correspond to prominence on the metrical grid, or in the Quantity Sensitivity parameter of Hayes 1981, which holds that heavy syllables should not be the non-heads of feet. The second is from stress to syllable weight as in the Obligatory Branching parameters of Hayes 1981 and Hammond 1986, each of which holds that the heads of feet should be bimoraic, or "branch" in the terms of earlier metrical theory.¹

As the difference between the two directions has been thoroughly discussed in previous accounts, at least with respect to the above mechanisms, I will not go into great detail here but will only illustrate how the demands of the two differ in general. First, as demonstrated in (1), the relationship from weight to stress can discriminate between stressed heavy syllables and unstressed heavy syllables, but it cannot, as demonstrated in (2), discriminate between stressed heavy syllables and stressed light syllables.

(1) Weight to Stress: Stressed Heavy vs. Unstressed Heavy

	Weight to Stress
a. $\begin{array}{c} x \\ \mu \quad \mu \\ \diagdown \quad / \\ \sigma \end{array}$	
b. $\begin{array}{c} \mu \quad \mu \\ \diagdown \quad / \\ \sigma \end{array}$	*

¹ In Hayes 1981, obligatory branching feet are always also quantity sensitive, but, in Hammond 1986, obligatory branching feet are always also quantity insensitive.

In (1), weight to stress rejects the unstressed heavy syllable in favor of the stressed heavy syllable because it demands that all heavy syllables be stressed.

(2) Weight to Stress: Stressed Heavy vs. Stressed Light

	Weight to Stress
a. $\begin{array}{c} x \\ \mu \quad \mu \\ \downarrow \quad \swarrow \\ \sigma \end{array}$	
b. $\begin{array}{c} x \\ \mu \\ \\ \sigma \end{array}$	

In (2), weight to stress does not reject the stressed light syllable in favor of the stressed heavy syllable because it does not demand that light syllables not be stressed.

The relationship from stress to weight obtains just the opposite results. As (3) demonstrates, stress to weight cannot discriminate between stressed heavy syllables and unstressed heavy syllables, but as (4) demonstrates, it can distinguish between stressed heavy syllables and stressed light syllables.

(3) Stress to Weight: Stressed Heavy vs. Unstressed Heavy

	Stress to Weight
a. $\begin{array}{c} x \\ \mu \quad \mu \\ \downarrow \quad \swarrow \\ \sigma \end{array}$	
b. $\begin{array}{c} \mu \quad \mu \\ \downarrow \quad \swarrow \\ \sigma \end{array}$	

In (3), stress to weight does not reject the unstressed heavy syllable in favor of the stressed heavy syllable because it does not demand that all heavy syllables be stressed.

(4) Stress to Weight: Stressed Heavy vs. Stressed Light

	Stress to Weight
a. x μ μ / σ	
b. x μ σ	*

In (4), stress to weight rejects the stressed light syllable in favor of the stressed heavy syllable because it demands that light syllables not be stressed.

In this chapter, we will examine the connection between syllable weight and stress from the perspective of both weight to stress and stress to weight. The mechanisms responsible in the proposed account for the relationship from weight to stress are MapGM (Ft); the Weight-to-Head constraint, introduced in Chapter 2; and Hvy-Rt and Hvy-Lft, two Window constraints that will be introduced below. The mechanisms primarily responsible for the relationship from stress to weight are constraints demanding moraic NonFinality within the domains of prosodic words, feet, and syllables.

5.1 Weight to Stress

In the proposed account, the effects of the weight to stress relationship are not obtained by a single constraint but by three different types. We have already seen two at work. MapGM (Ft), repeated in (5), has been instrumental throughout the preceding chapters, and the Weight-to-Head constraint, repeated in (6), was instrumental in the analysis of Seminole/Creek in chapter 2.

(5) MapGM (Ft)

A foot-level gridmark is realized within the domain of every foot.

(6) Weight-to-Head

Every heavy syllable must be the head of some foot.

In some cases, as we will see next in the stress pattern of Hixkaryana, the combination of Weight-to-Head and MapGM (Ft) seems sufficient to ensure that heavy syllables are stressed. There are cases, however, where additional constraints come into play. The additional constraints are moraic Window constraints within the domain of the foot. These will be introduced further below.

5.1.1 Hixkaryana

The stress pattern of Hixkaryana (Derbyshire 1985) illustrates how the relationship from weight to stress can circumscribe the demands of foot-head alignment constraints. Hixkaryana is essentially an even offbeat language, but as (7) illustrates, out-of-phase heavy syllables may perturb the basic pattern.

(7) Hixkaryana Forms (from Derbyshire 1985)

ĹLL	toróno	<i>small bird</i>
ĹLLL	atxówowo	<i>wind</i>
ĹLĹL	nemókotóno	<i>it fell</i>
ĹĹH́L	khanáníhno	<i>I taught you</i>
H́ĹLL	tóhkuryéhona	<i>to Tohkurye</i>

Stress in Hixkaryana occurs on each heavy syllable. Stress also occurs on even-numbered syllables in strings of light syllables, unless such a syllable is also the final syllable. It should also be noted that stressed open syllables are lengthened on the surface, a circumstance that we will return to in section 5.2.3.2 below.

There are two steps in obtaining the stress pattern of Hixkaryana. The first is to establish a basic even offbeat pattern. This is accomplished, as we saw in Chapter 4, with the following ranking:

(8) Even Offbeat Ranking

SNonFinality, Hds-Right >> MapGM (Ft)

The second step is to prevent the rightward directionality and iambic footing produced by Hds-Right from skipping heavy syllables. This is accomplished simply by ranking Weight-to-Head over Hds-Right, as in (9).

(9) Hixkaryana Ranking

SNonFinality, Weight-to-Head >> Hds-Right >> MapGM (Ft)

The final step is to ensure that the heavy syllables, as well as other appropriated heads, are stressed. This is accomplished using MapGM (Ft) without altering its position in the ranking.

As (10) demonstrates using /tóhkuryéhona/, ranking Weight-to-Head over Hds-Right ensures that heavy syllables will be designated as foot-heads independently of the influences of foot-head alignment. In particular, ranking Weight-to-Head over Hds-Right ensures that heavy syllables cannot be non-heads, as in candidate (d), in order to maintain the best possible rightward foot-head alignment. Although Hds-Right does not have the influence to ignore heavy syllables, it still has sufficient influence to prevent foot-heads from occurring further to the left than necessary, as in candidate (c). Finally, MapGM (Ft) ensures that heavy syllables, as well as other non-final heads, do not remain stressless, as in candidate (b). (Only candidates that satisfy SNonFinality are considered.)

(10) Weight-to-Head >> Hds-Right >> MapGM (Ft)

tohkuryehona	W2Head	Hds-Right	MapGM (Ft)
<p>a.toh kurye ho na</p>		** *****	*
<p>b.toh kurye ho na</p>		** *****	**!*
<p>c.toh kurye ho na</p>		* *****!*	
<p>d.toh kurye ho na</p>	*!	* ***	

In (10), each candidate is a five-syllable form with an initial heavy syllable. By allowing the heavy syllable to be a non-head, candidate (d) is able to perform as well as possible on Hds-Right given the length of the form, but it drops out because this same situation forces (d) to violate Weight-to-Head where (a-c) do not. Although candidate (c) satisfies Weight-to-Head, it drops out because its trochaic footing prevents it from performing as well on Hds-Right as the iambic (a) and (b). Candidates (a) and (b) perform equally well on the higher ranked constraints, but because (b) leaves the heavy syllable, as well as other non-final heads, stressless, (b) has more violations of MapGM (Ft) than (a). Candidate (a) emerges as the winner.

Before moving on, it is worth remembering that not only does Hds-Right not have sufficient influence in the (10) ranking to allow heavy syllables to be skipped, but it also

does not have sufficient influence to create a structure like (11) in which the non-violable Lapse Condition is ignored.

(11) Banned by Lapse Condition

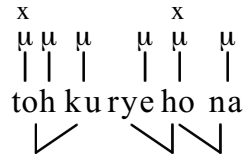

The perturbations in the stress pattern of Hixkaryana, then, are obtained simply by introducing Weight-to-Head to the even offbeat ranking so that Weight-to-Head dominates Hds-Right. This prevents the basically rightward iambic pattern from skipping heavy syllables. MapGM (Ft) ensures that heavy syllables and other appropriate heads are stressed.

5.1.2 Moraic Windows in the Foot

Although there are cases where Weight-to-Head and MapGM (Ft) seem to be sufficient, obtaining the full effects of the weight to stress relationship requires two additional constraints: Hvy-Rt and Hvy-Lft. Both are Window constraints establishing bimoraic stress windows for foot-level gridmarks within the domain of the foot:

(12) Moraic Window Constraints within the Domain of the Foot

Hvy-Rt or Align (Mora-DC(Ft), L, Ft-GM, R): The left edge of every moraic descent category within the domain of the foot is aligned with the right edge of its foot-level gridmark.

Hvy-Lft or Align (Mora-DC(Ft), R, Ft-GM, L): The right edge of every moraic ascent category within the domain of the foot is aligned with the left edge of its foot-level gridmark.

By demanding that the left edge of moraic descent categories within the domain of the foot be aligned with the right edge of their foot-level gridmark, Hvy-Rt limits the position of the foot-level gridmark to a bimoraic window at the right edge of the foot. Similarly, by demanding that the right edge of moraic ascent categories within the domain of the foot be aligned with the left edge of their foot-level gridmark, Hvy-Lft limits the position of the foot-level gridmark to a bimoraic window at the left edge of the foot.

In feet containing only light syllables, Hvy-Rt and Hvy-Lft will always be satisfied. Any foot with less than three moras will not be capable of violating the constraints because the foot-level gridmark can never be more than one mora away from either edge. The tables in (13) and (14) illustrate the preferences of the Window constraints with respect to feet containing heavy syllables. As (13) illustrates, both Hvy-Rt and Hvy-Left are satisfied vacuously by a stressless foot. Both are also satisfied non-vacuously by a stressed monosyllabic foot and by a stressed LH iamb. As (14a, b) illustrate, both constraints will be violated when a heavy syllable intervenes between the foot-level gridmark and the relevant edge, and as (14c) illustrates, Hvy-Rt will also be violated by a stressed HL trochee.

(13) Satisfaction of Hvy-Rt and Hvy-Lft

	Hvy-Rt	Hvy-Lft
<p>a. σ σ</p> <p style="margin-left: 40px;">x</p> <p style="margin-left: 40px;">x x</p> <p style="margin-left: 40px;">u u</p> <p>b. σ</p> <p style="margin-left: 40px;">x</p> <p style="margin-left: 40px;">x x x</p> <p style="margin-left: 40px;">u u u</p> <p>c. σ σ</p>		

In (13), the (a) candidate is a stressless foot. Because it has no foot-level gridmarks, there are no moraic slope categories to be aligned, and (a) vacuously satisfies both Hvy-Rt and Hvy-Lft. The (b) candidate is a stressed monosyllabic foot. Candidate (b) satisfies Hvy-Rt because the single moraic descent category is aligned with the gridmark, and it satisfies Hvy-Lft because there are no moraic ascent categories to be aligned. Finally, candidate (c) is an LH iamb. Because the foot-level gridmark occurs on the medial mora of three (the initial

mora of the heavy syllable), the only moraic ascent category is aligned with the gridmark and the only moraic descent category is aligned with the gridmark. Candidate (c) satisfies both Hvy-Rt and Hvy-Left, as well.

(14) Violation of Hvy-Rt and Hvy-Left

	Hvy-Rt	Hvy-Lft
<p>a.</p>		*
<p>b.</p>	*	
<p>c.</p>	*	

In (14), the (a) candidate is an HL iamb, and the foot-level gridmark occurs on the final of three moras. Because there are no moraic descent categories, (a) satisfies Hvy-Rt, but because there are two moraic ascent categories, (a) violates Hvy-Lft. The (b) candidate is an LH trochee, and the (c) candidate is an HL trochee. In both cases, the foot-level gridmark occurs on the initial mora of three. Because there are no moraic ascent categories, (b) and (c) satisfy Hvy-Lft, but because there are two moraic descent categories, (b) and (c) violate Hvy-Rt.

It is interesting to note the pattern that emerges when the window constraints are both satisfied. When heavy syllables occur in a stressed foot, Hvy-Rt and Hvy-Lft combine to ensure that the foot is right-headed, either a monosyllable or an iamb. In other words, the combination of Hvy-Rt and Hvy-Lft prefers the moraic trochees and LH iambs so important

in certain earlier accounts of weight-sensitivity— for example, in the foot-inventory of Hayes 1995.

5.1.3 Combined Effects

None of the three constraint types— MapGridmark, Weight-to-Head, or Window— by itself is sufficient to ensure that heavy syllables are stressed in all cases. For example, MapGM (Ft) demands that feet have gridmarks within their domain, but it does not ensure that a heavy syllable within that domain will carry the gridmark. The Weight-to-Head constraint ensures that a heavy syllable will be a head, but it does not ensure that the head will be stressed. Finally Hvy-Rt and Hvy-Lft can force stress to occur on a heavy syllable within a stressed foot, but since they can be satisfied vacuously by a stressless foot, some other constraint must force the foot to be stressed in the first place.

To illustrate, Weight-to-Head and Hvy-Right could both accept a heavy syllable occurring in a stressless foot. It takes MapGM (Ft) to ensure that the heavy syllable is stressed:

(15) Avoiding Stressless Feet

	W2Head	Hvy-Rt	MapGM (Ft)
<p>a.</p>			
<p>b.</p>			*!

In (15), both candidates are iambic feet with a final heavy syllable. Candidate (a) has stress on its heavy syllable, and candidate (b) is stressless. Both candidates satisfy the Weight-to-Head constraint because the heavy syllable is the head in both feet. Both candidates also

satisfy Hvy-Rt, candidate (a) because it has no foot-level gridmark and no moraic descent categories to be aligned and candidate (b) because its single moraic descent category is aligned with its foot-level gridmark. Only MapGM (Ft) prefers candidate (a) over candidate (b). This is because the foot in candidate (a) is stressed where the foot in candidate (b) is not.

Consider next a sequence of two syllables where the first is heavy and the second light. MapGM (Ft) and Hvy-Rt would tolerate a single foot with stress on the light syllable. It takes the Weight-to-Head constraint to ensure that the heavy syllable is footed separately and stressed as well:

(16) Avoiding Stresslessness in a Stressed Foot

	MapGM (Ft)	Hvy-Rt	W2Head
<p>a.</p>			
<p>b.</p>			*!

In (16), both candidates have a heavy syllable followed by a light syllable. Candidate (a) parses its syllables into two separate feet, both of which are stressed. Candidate (b) parses its syllables into a single iambically stressed foot. Both candidates satisfy MapGM (Ft) because every foot in each is associated with a foot-level gridmark. Both candidates also satisfy Hvy-Right. The first foot in candidate (a) has a single moraic descent category aligned with the foot-level gridmark, and the second foot has no moraic descent categories to be aligned. The foot in candidate (b) also has no moraic descent categories. Only Weight-to-

Head prefers candidate (a) over candidate (b). This is because the heavy syllable in (a) is a head where the heavy syllable in (b) is not.

Finally, consider a string of syllables where the first and second are light and the third is heavy. MapGM (Ft) and Weight-to-Head would be satisfied if the syllables were parsed using intersecting feet and stress occurred only on the second light syllable in a gridmark sharing configuration. It takes Hvy-Rt to ensure that the heavy syllable is parsed in a separate foot and stressed as well:

(17) Avoiding Gridmark Sharing

	MapGM (Ft)	W2Head	Hvy-Rt
<p>a.</p>			
<p>b.</p>			*!

In (17), both candidates contain two light syllables followed by a heavy syllable. Candidate (a) parses these syllables into two non-intersected feet, an iamb followed by a monosyllable. Candidate (b) parses the syllables into two intersecting iambs. Both candidates satisfy MapGM (Ft) because every foot in each candidate has a foot-level gridmark within its domain. Both candidates also satisfy Weight-to-Head because the heavy syllable in each is the head of a foot. Only Hvy-Right prefers candidate (a) over candidate (b). Candidate (a) satisfies Hvy-Right because its first foot has no moraic descent categories and its second foot has only a single appropriately aligned descent category. Candidate (b) violates Hvy-Right because it has two moraic descent categories in its second foot.

In further examining the stress pattern of Cahuilla below, we will encounter a situation where all three constraint types are active in obtaining the appropriate configuration. In particular, we will encounter a situation where Hvy-Rt is instrumental in determining the shape of feet in which heavy syllables occur.

5.1.4 Cahuilla

As we saw in Chapter 4, the primary mechanisms for determining the positions of feet in Cahuilla are IntPG and RWin. IntPG positions primary stress over a form's initial syllable, and the lower ranked RWin draws any podal descent categories towards the primary stress. This effectively creates leftward footing. We also saw that, although foot-head alignment is to the left, a high ranking of *Clash may force non-initial foot-heads rightward. The result was that the basic Cahuilla pattern is one of trochaic maximal alternation, the pattern exhibited by the first two forms in (18).

(18) Cahuilla Forms (from Hayes 1995)

́LL̀	táxmuʔàt	<i>song</i>
́LLL	tákaličem	<i>one-eyed ones</i>
́HL̀	háʔtìsqal	<i>he is sneezing</i>
́HL̀	súkàʔtì	<i>the deer (obj.)</i>
́LH̀̀	táxmuʔàʔtì	<i>the song (obj.)</i>

As the final three forms in (18) illustrate, however, the presence of heavy syllables may perturb the basic maximal alternation pattern. We have already encountered one example. When the initial syllable is heavy, as in /háʔtìsqal/, *Clash does not conflict with leftward foot-head alignment, and a double downbeat pattern emerges.

Non-initial heavy syllables affect the pattern as well. In /táxmuʔàʔtì/, stressing the heavy syllable causes a pattern that is unlike either the maximal alternation or double downbeat patterns. The same is true of /súkàʔtì/. The stressed light syllables immediately fol-

lowing the heavy syllables in /táxmuʔàʔtì/ and /súkàʔtì/ are of particular interest. Stress in this position indicates that the heavy syllables must not only be heads and stressed, they must also be the heads of right-headed feet and cannot participate in gridmark-sharing configurations. To illustrate, the structure in (19a) is sufficient to ensure that the heavy syllable in /táxmuʔàʔtì/ is a stressed head, and the structure in (19b) is sufficient to ensure that the heavy syllable of /súkàʔtì/ is a stressed head.

(19) Heavy Syllable in Trochees



The (19) structures have the advantage of satisfying RWin as well as possible given the position of primary stress and the length of the forms. They exhibit the best possible leftward foot-head alignment given the length of the forms. They also have the advantage of respecting the Weight-to-Head and MapGM (Ft) constraints. They do not, however, obtain the necessary stress over the final light syllables. To force the addition of a separate final foot, it is necessary that the feet containing heavy syllables be right-headed.

Even right-headed feet, however, are not sufficient to create the final stress. The newly added final foot might still participate in a gridmark-sharing configuration, as in the structures in (20).

(20) Heavy Syllables in Intersections

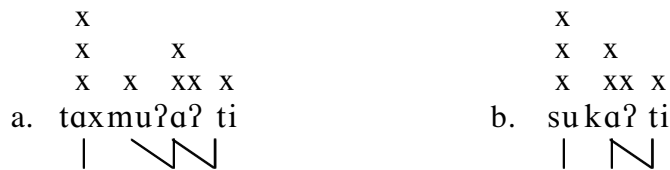

In such cases, the structures maintain the advantage of satisfying Weight-to-Head and MapGM (Ft), but they still do not obtain the necessary final stress. The final syllable must occur in its own non-intersected foot.

To obtain the appropriate configurations, the weight-to-stress constraints MapGM (Ft), Weight-to-Head, and Hvy-Rt must be introduced into the core Cahuilla ranking from Chapter 4, repeated in (21).

(21) Cahuilla Ranking from Chapter 4

IntPG >> *Clash, RWin >> Hds-Left

(22) Revised Cahuilla Ranking

Weight-to-Head, MapGM (Ft), Hvy-Right, IntPG, >> *Clash, RWin >> Hds-Right

In particular, Weight-to-Head and MapGM (Ft) must be positioned with IntPG above *Clash and RWin, as in (22), and Hvy-Rt must be positioned at least above RWin.

As (23) demonstrates, it is necessary to rank IntPG, Weight-to-Head, and MapGM (Ft) above *Clash in order to obtain the clash configuration in /súkàʔtì/. Ranking IntPG over *Clash ensures that primary stress does not shift from the initial syllable, as in candidate (d), in order to avoid clash. Ranking Weight-to-Head over *Clash ensures that a heavy syllable may not be a non-head, as in candidate (c), to avoid clash. Finally, ranking MapGM (Ft) over *Clash ensures that the heavy syllable is not left stressless, as in candidate (b), to avoid clash.

(23) IntPG, Weight-to-Head, MapGM (Ft) >> *Clash

suka?ti	IntPG	W2Head	MapGM (Ft)	*Clash
<pre> x x x x x x x x μ μ μ μ a. su ka? ti </pre>	*			*
<pre> x x x x x x μ μ μ μ b. su ka? ti </pre>	*		*!	
<pre> x x x x x x x μ μ μ μ c. su ka? ti </pre>	*	*!		
<pre> x x x x x x x μ μ μ μ d. su ka? ti </pre>	**!			

In (23), each candidate contains three syllables, the second of which is heavy. Shifting primary stress away from its initial syllable allows candidate (d) to satisfy Weight-to-Head, *Clash, and MapGM (Ft), but because it also creates an additional violation of IntPG, (d) drops out. Shifting stress from the heavy syllable to the final syllable allows candidate (c) to satisfy *Clash and MapGM (Ft) and to satisfy IntPG as well as possible, but because it also causes a violation of Weight-to-Head where (a) and (b) have none, (c) drops out as well. Leaving its final foot stressless allows candidate (b) to satisfy Weight-to-Head and *Clash and to satisfy RWin as well as possible, but it also cause (b) to violate MapGM (Ft)

where (a) does not. Although the stressing both the initial and heavy syllables causes candidate (a) to violate *Clash, it also allows (a) to do well enough on the higher ranked constraints to emerge as the winner.

As (24) illustrates, also using /súkàʔtì/, it is necessary to rank Weight-to-Head, MapGM (Ft), and Hvy-Right above RWin and Hds-Right. This forces the foot containing the heavy syllable to be stressed and right-headed. Ranking Weight-to-Head over RWin and Hds-Right ensures that a heavy syllable cannot be a non-head, as in candidate (d), in order to promote better leftward descent category alignment or foot-head alignment. Ranking MapGM (Ft) over RWin and Hds-Right ensures that the foot containing the heavy syllable cannot be a stressless trochee, as in (c), in order to promote better leftward descent category alignment or foot-head alignment. Finally, ranking Hvy-Rt over RWin and Hds-Right ensures that the foot containing the heavy syllable cannot be a stressed trochee, as in candidate (b), in order to better promote better leftward descent category alignment or foot-head alignment. (Only candidates which satisfy IntPG are considered.)

(24) Weight-to-Head, MapGM (Ft), Hvy-Rt >> RWin >> Hds-Left

suka?ti	W2Head	MapGM (Ft)	Hvy-Right	RWin	Hds-Right
<pre> x x x x x x x x μ μ μ μ a. su ka? ti </pre>				**	** **
<pre> x x x x x x x μ μ μ μ b. su ka? ti ✓ </pre>			*!		*
<pre> x x x x x x μ μ μ μ c. su ka? ti ✓ </pre>		*!			*
<pre> x x x x x x x μ μ μ μ d. su ka? ti ✓ </pre>	*!				*

In (24), each of the candidates is a three-syllable form where the second syllable is heavy. Candidate (d), which contains a monosyllable followed by a stressed iamb, drops out first. Although this configuration allows (b) to satisfy MapGM (Ft), Hvy-Rt, and RWin and to satisfy Hds-Right as well as possible given the length of the form, it also means allowing the heavy syllable to be a non-head, violating Weight-to-Head where (a-c) do not. Candidate (c), which contains a monosyllabic foot followed by a stressless trochee, drops out next. Although this configuration allows (c) to satisfy Weight-to-Head, Hvy-Right, and RWin and to satisfy Hds-right and as well as possible given the length of the form, including the

heavy syllable in a stressless foot causes (c) to violate MapGM (Ft) where (a) and (b) do not. Finally, Candidate (b), which contains a monosyllabic foot followed by a stressed trochee, drops out. Although this configuration allows (b) to satisfy Weight-to-Head, MapGM (Ft), and RWin and to satisfy Hds-right and as well as possible given the length of the form, including the heavy syllable in a stressed trochee causes (b) to violate Hvy-Rt where (a) does not. Candidate (a) parses each of the three syllables into separate monosyllabic feet. Although this causes (a) to perform less well on RWin and Hds-Left, it also allows (a) to do well enough on the higher ranked Weight-to-Head, MapGM (Ft), and Hvy-Rt to emerge as the winner.

Finally, as (25) demonstrates using /táxmuʔáʔti/ this time, ranking Hvy-Rt in particular over RWin and Hds-Right prevents heavy syllables from being stressed in intersections. This is the last step in ensuring that final stress emerges.

(25) Hvy-Rt >> RWin

taxmuʔáʔti	Hvy-Rt	RWin
<pre> x x x x x x x x x µ µ µ µ µ a.taxmuʔáʔ ti \ </pre>		***
<pre> x x x x x x x x µ µ µ µ µ b.taxmuʔáʔ ti / \ \ </pre>	*!	*

In (25), both candidates contain four syllables, and the third syllable in each candidate is heavy and stressed. Because the edge of the final foot in candidate (b) is allowed to move leftward intersecting the preceding foot, (b) performs better on RWin than candidate (a). By

allowing the final foot to participate in an intersection, however, candidate (b) violates Hvy-Right. Since the intersected syllable is heavy and stressed, there are two moraic descent categories between the edge of the final foot and the foot-level gridmark. Because the final foot does not include the heavy syllable in candidate (a), (a) does not violate Hvy-Rt. Since Hvy-Rt is the higher ranked constraint, candidate (a) emerges as the winner.

To obtain the appropriate perturbations in the Cahuilla stress pattern, then, it is not enough simply to require stress on heavy syllables. It is also necessary to control the shape of the foot in which stressed heavy syllables occur and to ensure that stressed heavy syllables do not occur in intersections. This demands that Weight-to-Head, MapGM (Ft), and Hvy-Rt all be highly ranked.

5.1.5 Summary

The proposed account obtains the effects of the weight to stress relationship not with a single constraint but with a combination of three types. The constraints that we focused on in the discussion above were Weight-to-Head, MapGM (Ft), and Hvy-Rt. Weight-to-Head ensured that heavy syllables were the heads of feet. MapGM (Ft) helped to ensure that heavy syllables and other heads were actually stressed. Finally, Hvy-Right determined the shape of feet in which stressed heavy syllables occurred and ensured that stressed heavy syllables did not occur in intersections.

5.2 Stress to Weight

In the proposed account, the relationship from stress to weight is produced by moraic Non-Finality constraints in several domains. Because they prohibit stress from falling on the final mora of the relevant domain, moraic NonFinality constraints also prohibit stress from falling on the domain's final syllable— unless the final syllable happens to be heavy. In the discussion that follows, we will examine moraic NonFinality within three prosodic categories: the prosodic word, the foot, and the syllable:

(26) Moraic NonFinality Constraints

a. Moraic NonFinality in the Prosodic Word

MNonFinality or NonFin (Ft-GM, Mora, PrWd): Every foot-level gridmark has a moraic descent category within the domain of the prosodic word.

b. Moraic NonFinality in the Foot

ILength or NonFin (Ft-GM, Mora, Ft): Every foot-level gridmark has a moraic descent category within the domain of the foot.

c. Moraic NonFinality in the Syllable

OBranchFG or NonFin (Ft-GM, Mora, Syll): Every foot-level gridmark has a moraic descent category within the domain of the syllable.

OBranchPG or NonFin (PrWd-GM, Mora, Syll): Every PrWd-level gridmark has a moraic descent category within the domain of the syllable.

Moraic NonFinality in the prosodic word produces weight-sensitivity in the final syllable of prosodic words, moraic NonFinality in the foot produces weight-sensitivity in the final syllable of feet, and moraic NonFinality in the syllable produces weight-sensitivity in syllables generally.

It is worth remembering here that moraic NonFinality constraints, just like their syllabic counterparts, are capable of producing word minimality effects. If stress cannot occur on the final mora of either a syllable, a foot, or a prosodic word, then a form must be bimoraic in order to be stressed at all. Although this is an important characteristic of moraic NonFinality constraints and one that deserves further attention, I will focus below on moraic NonFinality's effects on larger stress patterns.

5.2.1 Moraic NonFinality within the Prosodic Word

The first constraint that we will examine is the moraic counterpart to the syllabic SNonFinality constraint discussed in Chapter 4. It is the constraint responsible for producing weight-sensitivity in the rightmost syllable of prosodic words:

(27) NonFinality in the Prosodic Word

MNonFinality or NonFin (Ft-GM, Mora, PrWd): Every foot-level gridmark has a moraic descent category within the domain of the prosodic word.

MNonFinality’s requirement that every foot-level gridmark have a moraic descent category within the prosodic word essentially means that a prosodic word’s final mora must be stressless. It does not matter how many foot-level gridmarks a candidate has or where they occur, so long as they do not occur on the final mora of a prosodic word:

(28) Satisfaction of MNonFinality

μμμμμμ	MNonFinality
a. x x x μ μ μ μ μ μ	
b. x x x x μ μ μ μ μ μ	*

In (28), the two candidates are prosodic words containing six moras. Candidate (a) has foot-level gridmarks over the first, third, and fifth. Since each of its entries is followed by at least one mora, candidate (a) incurs no violations of MNonFinality. Candidate (b) has entries over the first, third, and fifth moras as well, but has an additional entry over the sixth. Since the first three gridmarks are each followed by a mora, they produce no violations of MNonFinality. The fourth gridmark, however, is not followed by a mora, resulting in the (b) candidate’s single violation.

In certain situations, the demands of MNonFinality are equivalent to those of SNonFinality. In prosodic words where the final syllable is light, having a gridmark entry over the final syllable entails having an entry over the final mora, and having an entry over the final mora entails having an entry over the final syllable. When comparing such candidates, both constraints require that stress be absent from the final syllable/mora:

(29) Situation of Equivalence

LLLL	SNonFinality	MNonFinality
a. x μ μ μ μ σ σ σ σ		
b. x μ μ μ μ σ σ σ σ	*	*

In (29), the final syllable of both candidates is monomoraic. The difference between them is that the foot-level gridmark of candidate (b) occurs over its final syllable/mora where the foot-level gridmark of candidate (a) occurs over the penult. Since the gridmark of candidate (b) has neither a syllabic nor a moraic descent category in the prosodic word, (b) violates both SNonFinality and MNonFinality, but since the gridmark of candidate (a) has both a syllabic and moraic descent category, (a) violates neither constraint.

The situations of particular interest here are those where the demands of MNonFinality are not equivalent to those of SNonFinality. In prosodic words where the final syllable is heavy, having a gridmark entry over the final mora entails having an entry over the final syllable, but having an entry over the final syllable does not entail having an entry over the final mora. When comparing such candidates, MNonFinality can tolerate stress on the final syllable where SNonFinality cannot:

(30) Situation of Non-Equivalence

LLLH	SNonFinality	MNonFinality
a. x μ μ μ μ μ σ σ σ σ		
b. x μ μ μ μ μ σ σ σ σ	*	

In (30), the final syllable of both candidates is bimoraic. Candidate (a) has a foot-level gridmark over the penult, and candidate (b) has a foot-level gridmark over the initial mora of the ultima. Since the gridmark of candidate (a) has both syllabic and moraic descent categories, (a) violates neither SNonFinality nor MNonFinality. Since the gridmark of candidate (b) has a moraic descent category but no syllabic descent category, (b) satisfies MNonFinality and violates SNonFinality.

MNonFinality treats final syllables differently, then, depending on their weight. Although it does not tolerate stress on light final syllables, MNonFinality does tolerate stress on heavy final syllables.

5.2.1.1 Constraint Interactions

In Chapter 4, we examined the interactions between SNonFinality, Hds-Right, and MapGM (Ft), and we saw that these interactions were responsible for distinguishing between the trochaic maximal alternation, double offbeat, and internal ternary patterns and for distinguishing between the iambic minimal alternation, even offbeat, and even downbeat patterns. The reason that these distinctions were possible was that SNonFinality, Hds-Right, and MapGM (Ft) conflicted in their preferences with respect to the treatment of final feet. In the trochaic variations, for example, ranking Hds-Right and MapGM (Ft) above SNonFinality obtained a final stressed iamb and the maximal alternation pattern, ranking Hds-Right and SNonFinality above MapGM (Ft) obtained a stressless final iamb and the double offbeat pattern, and ranking MapGM (Ft) and SNonFinality above Hds-Right obtained a stressed final trochee and the internal ternary pattern.

For MNonFinality the crucial interactions are similar, but MNonFinality does not always conflict with Hds-Right and MapGM (Ft). The constraints are only in conflict when the competition is between candidates with a light final syllable. Under such circumstances the ranking between them will decide whether a trochaic minimal alternation, double offbeat, or internal ternary pattern emerges. When the competition is between candidates with a

heavy final syllable, however, the constraints are not in conflict. They are each able to agree on a stressed final iamb, and the minimal alternation pattern will emerge.

Consider in (31) the conflicting preferences of MNonFinality and MapGM (Ft) when the candidates have a final light syllable and in (32) the non-conflicting preferences of MNonFinality and MapGM (Ft) when the candidates have a final heavy syllable. In (31), MNonFinality prefers a stressless final iamb and MapGM (Ft) prefers a stressed final iamb, but in (32), MNonFinality and MapGM (Ft) agree on a stressed final iamb.

(31) MNonFinality and MapGM (Ft): Light Final Syllable

	MNonFinality	MapGM (Ft)
<p>a. $\begin{array}{c} \mu \quad \mu \\ \quad \\ \dots \sigma \quad \sigma \\ \quad \quad \diagdown \end{array}$</p>		*
<p>b. $\begin{array}{c} \quad \quad x \\ \quad \quad \\ \mu \quad \mu \\ \quad \\ \dots \sigma \quad \sigma \\ \quad \quad \diagdown \end{array}$</p>	*	

In (31), both candidates are the final iamb of a prosodic word, and both have a light final syllable. Because the iamb of candidate (a) is stressless, there is no foot-level gridmark to incur an MNonFinality violation. The lack of a gridmark, however, causes (a) to violate MapGM (Ft). Because the iamb of candidate (b) has a foot-level gridmark, it satisfies MapGM (Ft), but the gridmark also occurs over the final mora, violating MNonFinality. MNonFinality prefers candidate (a), and MapGM (Ft) prefers candidate (b).

(32) MNonFinality and MapGM (Ft): Heavy Final Syllable

	MNonFinality	MapGM (Ft)
<p>a. </p> <p>b. </p>		*

In (32), both candidates are again the final iamb of a prosodic word, but this time they have heavy final syllables. Because the iamb of candidate (a) is stressless there is no foot-level gridmark to violate MNonFinality, but the lack of a gridmark also causes (a) to violate MapGM (Ft). Because the iamb of candidate (b) has a foot-level gridmark it satisfies MapGM (Ft). Because the final syllable is heavy and the gridmark does not occur on the final mora, candidate (b) also satisfies MNonFinality. Both MNonFinality and MapGM (Ft) agree on candidate (b).

Consider next in (33) the conflicting preferences of MNonFinality and Hds-Right when the candidates have a final light syllable and in (34) the non-conflicting preferences of MNonFinality and Hds-Right when the candidates have a final heavy syllable. In (33), MNonFinality prefers a stressed final trochee and Hds-Right prefers a stressed final iamb, but in (34), MNonFinality and Hds-Right can both agree on a stressed final iamb.

(33) MNonFinality and Hds-Right: Light Final Syllable

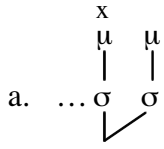
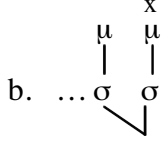
	MNonFinality	Hds-Right
<p>a. </p> <p>b. </p>		*
	*	

In (33), both candidates are stressed prosodic word-final feet, and both have light final syllables. The foot in candidate (a) is a trochee, and the foot in candidate (b) is an iamb. Because candidate (a) is trochaic, it is not stressed on the final mora and satisfies MNonFinality. Also because it is trochaic, however, it has more violations of Hds-Right than the iambic (b). Because candidate (b) is iambic it satisfies Hds-Right, but its stress on the final mora causes (b) to violate MNonFinality. Hds-Right prefers candidate (b), and MNonFinality prefers candidate (a).

(34) MNonFinality and Hds-Right: Heavy Final Syllable

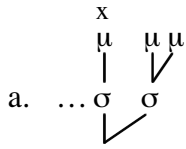
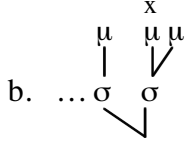
	MNonFinality	Hds-Right
<p>a. </p> <p>b. </p>		*

In (34), both candidates are again stressed prosodic word-final feet, but this time they have heavy final syllables. The foot in candidate (a) is trochaic, and the foot in candidate (b) is iambic. Because the foot in candidate (a) is trochaic it has one more violation of Hds-Right

than the iambic (b), but because stress does not occur on its final mora (a) satisfies MNon-Finality. Because the foot in candidate (b) is iambic it satisfies Hds-Right, and because the final syllable is heavy and stress does not occur on the final mora it satisfies MNonFinality as well. MNonFinality and Hds-Right are both able to agree on candidate (b).

The interactions of MNonFinality, Hds-Right, and MapGM (Ft), then, create the possibility of mixed systems. When a form has a heavy final syllable, the constraints all agree on a final stressed iamb. When a form has a light final syllable, the constraints do not agree, and the ranking between them decides whether a stressed final iamb, stressless final iamb, or stressed final trochee emerges. In trochaic systems, this creates the possibility of a language which exhibits the minimal alternation pattern in forms with heavy final syllables but exhibits either the double offbeat or internal ternary pattern in forms with light final syllables.

5.2.1.2 A Mixed System: Wergaia

The stress pattern of Wergaia (Hercus 1986), in which heavy syllables are CVC, illustrates a situation where the trochaic minimal alternation pattern emerges in odd-parity forms with heavy final syllables and the trochaic double offbeat pattern emerges in odd-parity forms with light final syllables. Notice in the example forms below that heavy syllables only cause a departure from the double offbeat pattern when they are final, so that weight sensitivity is truly limited to the prosodic word-final syllable:

(35) Wergaia Forms (from Hercus 1986)

́L	gáma	<i>common black wallaby</i>
́H	bébul	<i>fat, kidney fat</i>
́LL	gúrewa	<i>bird, hoary-headed grebe</i>
́HL	bíringe	<i>tea</i>
́LH	búnadùg	<i>broad-leaved mallee</i>
́LLL	wúregùda	<i>to go on talking</i>
́LLH	wúregwùraŋ	<i>speaking together, gabbling</i>

As illustrated in (35), stress in Wergaia always occurs on every odd-numbered syllable—except the final. When an odd-numbered syllable is also the final syllable, the presence of stress depends on the syllable’s weight. If the syllable is heavy, as in /búnadùg/, it is stressed, but if the syllable is light, as in /gúrewa/, it is not stressed.

The ranking for Wergaia is much the same as that for the double offbeat pattern from Chapter 4, except that MNonFinality replaces SNonFinality:

(36) Wergaia Ranking

PrWd-L >> Hds-Right, MNonFinality >> MapGM (Ft)

PrWd-L plays the familiar role of limiting rightward foot-head alignment. Ranking Hds-Right and MNonFinality above MapGM (Ft) ensures that when the three constraints are in conflict the demands of Hds-Right give way and a stressless final iamb emerges.

For odd-parity forms with a final light syllable, the (36) ranking ensures that the final foot will be stressless, as it is in the double offbeat pattern. As (37) illustrates using the three-syllable /gúrewa/, ranking Hds-Right above MapGM (Ft) ensures that the final foot-head cannot shift leftward, as in candidate (c), in order to preserve the foot-stress relationship, and ranking MNonFinality over MapGM (Ft) ensures that the final mora will not be stressed, as in candidate (b), in order to preserve the foot-stress relationship.

(37) Final Light Syllable: PrWd-L >> Hds-Right, MNonFinality >> MapGM (Ft)

gurewa	PrWd-L	Hds-Right	MNonFinality	MapGM (Ft)
		**		*
		**	*!	
		* **!		
	*!	*		

In (37), candidate (d) drops out first. Its thoroughly iambic footing allows it to satisfy MNonFinality and MapGM (Ft) and to satisfy Hds-Right as well as possible given the length of the form, but it also causes (d) to violate PrWd-L where (a-c) do not. Candidate (c) drops out next. Although the position of its final foot-head allows (c) to simultaneously satisfy MNonFinality and MapGM (Ft), it also causes (c) to have more violations of Hds-Right than either (a) or (b). The foot-level gridmark over its final syllable allows the maximal alternation candidate (b) to satisfy MapGM (Ft) and to meet the requirements of Hds-Right as well as possible (given the more pressing demands of PrWd-L and the Lapse Condition), but because the final syllable is light, the gridmark does not have a moraic descent category, and (b) violates MNonFinality where (a) does not. Although the absence of a foot-level gridmark within the domain of its final foot causes the double offbeat candidate (a) to violate MapGM (Ft), it also allows (a) to do well enough on MNonFinality and Hds-Right to emerge as the winner.

In odd-parity forms with a light final syllable, then, a conflict arises between Hds-Right, MNonFinality, and MapGM (Ft), so that the demands of the three constraints cannot

be met simultaneously. By ranking Hds-Right and MNonFinality above MapGM (Ft), the demands of MapGM (Ft) are sacrificed, and the appropriate double offbeat configuration is obtained.

As (38) illustrates using the three-syllable /búnadug/, however, no conflict arises when considering odd-parity forms with a heavy final syllable. Because stress can occur on the final syllable without also occurring on the final mora, the maximal alternation candidate meets the demands of the three constraints simultaneously and harmonically bounds its closest competitors. (Only candidates that satisfy PrWd-L are considered.)

(38) Final Heavy Syllable: Hds-Right, MNonFinality >> MapGM (Ft)

bunadug	Hds-Right	MNonFinality	MapGM (Ft)
^x a. bu na dug 	**		*!
^x ^x b. bu na dug 	**		
^x c. bu na dug 	* **!		

In (38), the double offbeat candidate (a) has a stressless final foot, the maximal alternation candidate (b) has stress on its final syllable, and candidate (c) shifts its final foot-head one syllable to the left. Candidate (b) meets the demands of Hds-Right as well as possible (given the more pressing requirements of PrWd-L and the Lapse Condition). It satisfies MNonFinality, because every foot-level gridmark has a moraic descent category, and it also satisfies MapGM (Ft). Although candidate (a) performs as well as (b) on Hds-Right and MNonFinality, it violates MapGM (Ft) where (b) does not, and although candidate (c) performs as well as (b) on MNonFinality and MapGM (Ft), it has one more violation than (b)

of Hds-Right. Since candidate (b) performs equally well or better on every constraint, (b) harmonically bounds (a) and (c).

The situation is similar for even-parity forms. As (39) illustrates using the four-syllable /wúregùda/, the desired even-parity pattern simultaneously meets the demands of the relevant constraints.

(39) Even-Parity Forms: Hds-Right, MNonFinality >> MapGM (Ft)

wureguda	PrWd-L	Hds-Right	MNonFinality	MapGM (Ft)
$\begin{array}{cc} x & x \\ \text{wu re} & \text{gu da} \\ \swarrow & \swarrow \end{array}$		* ***		

Its non-intersected trochaic footing allows the even-parity pattern to satisfy Hds-Right as well as possible (given the more pressing demands of PrWd-L and the Lapse Condition). At the same time, every foot has a foot-level gridmark within its domain, so that MapGM (Ft) is satisfied, and every foot-level gridmark has a moraic descent category within the prosodic word, so that MNonFinality is satisfied as well.

The properties of MNonFinality, then, play a crucial role in the stress pattern of Wergaia. Because MNonFinality bans stress from a final mora, but not necessarily from a final syllable, the trochaic double offbeat pattern emerges in odd-parity forms with a light final syllable, and the trochaic maximal alternation pattern emerges in odd-parity forms with a heavy final syllable.

5.2.2 Moraic NonFinality within the Foot

The second constraint that we will examine in connection with the stress to weight relationship is the ILength constraint. ILength, like MNonFinality, is a moraic NonFinality constraint, but ILength applies within the smaller foot domain:

(40) NonFinality in the Foot

ILength or NonFin (Ft-GM, Mora, Ft): Every foot-level gridmark has a moraic descent category within the domain of the foot.

In requiring that all foot-level gridmarks have a moraic descent category within the domain of a foot, ILength essentially requires that a foot's final mora be stressless. This circumstance creates a sensitivity to syllable weight in a foot's final syllable. If the final syllable is light, it cannot be stressed because this would mean that the final mora would also be stressed. If the final syllable is heavy, however, it may be stressed since this does not entail stressing the final mora.

As (41) demonstrates, ILength is slightly more flexible than Trochee, its syllabic counterpart from Chapter 4. ILength, like trochee, tolerates trochaic feet, as in candidate (a), but ILength also tolerates iambs with a heavy final syllable, as in candidate (c), and heavy monosyllables, as in candidate (e).

(41) Satisfaction of ILength

	ILength
a. $\begin{array}{c} x \\ \sigma \quad \sigma \\ \swarrow \quad \searrow \end{array}$	
b. $\begin{array}{c} \mu \quad \mu \quad x \\ \quad \quad \\ \sigma \quad \sigma \\ \swarrow \quad \searrow \end{array}$	*
c. $\begin{array}{c} \mu \quad \mu \quad x \\ \quad \quad \\ \sigma \quad \sigma \\ \swarrow \quad \searrow \end{array}$	
d. $\begin{array}{c} x \\ \mu \\ \\ \sigma \\ \end{array}$	*
e. $\begin{array}{c} \mu \quad \mu \quad x \\ \swarrow \quad \searrow \\ \sigma \\ \end{array}$	

In (41), the light monosyllable of candidate (d) violates ILength because the foot-level gridmark associated with this foot does not have a moraic descent category in the domain of the foot. The iamb with the light final syllable in candidate (b) violates the constraint for the same reason. The trochee of candidate (a), the LH iamb of candidate (c), and the heavy monosyllable of candidate (e) are each able to satisfy the constraint because the foot-level gridmarks associated with these feet are each followed by a mora.

5.2.2.1 Constraint Interactions

The most crucial interactions involving ILength are with Hds-Right, MapGM (Ft) and Dep. The interaction with Hds-Right is crucial because it is the constraint that typically produces iambic footing and, if ranked above ILength, takes away the option of satisfying ILength

using trochees. The interaction with MapGM (Ft) is crucial because, if ranked above ILength, it takes away the option of satisfying ILength vacuously. Finally, the interaction with Dep is crucial because it is the constraint that prohibits insertion of moras and, if ranked above ILength, takes away the option of satisfying ILength through iambic lengthening.

Consider first the conflicting preferences of ILength and Dep. In competitions between candidates with stressed iambic footing, ILength prefers that the stressed heads be heavy. If this means, however, that moras must be added to the output form, Dep prefers that the stressed heads remain light.

(42) ILength and Dep

	LLL	ILength	Dep
a.			**
b.		**	

In (42), both candidates exhibit iambic footing. The heads of the feet in candidate (a) are heavy, and the heads of the feet in candidate (b) are light. Because candidate (a) has more moras than are present in the input it violates Dep, but the additional moras also provide descent categories for the foot-level gridmarks and allow (a) to satisfy ILength. Because the gridmarks of candidate (b) do not have moraic descent categories in the domain of the foot, (b) violates ILength, but because it has not added to the input moras, (b) satisfies Dep.

Consider next the conflicting preferences of ILength and Hds-Right. In competitions between candidates with stressed iambic footing and candidates with stressed trochaic

footing (where the foot-heads are light), Hds-Right prefers iambic footing and ILength prefers trochaic footing.

(43) ILength and Hds-Right

	ILength	Hds-Right
<p>a. </p>		* **
<p>b. </p>	**	**

In (43), both candidates have stressed feet, and the heads of the feet are light. The trochaic footing of candidate (a) creates more violations of Hds-Right than the iambic footing of candidate (b), but its trochaic footing also allows (a) to have moraic descent categories for its foot-level gridmarks, satisfying ILength. The iambic footing of the (b) candidate allows it to perform better with respect to Hds-Right, but iambic footing also prevents the (b) candidate from having moraic descent categories for its foot-level gridmarks, violating ILength.

Finally consider the conflicting preferences of ILength and MapGM (Ft). In competitions between candidates whose feet are iambic (with light heads), MapGM (Ft) prefers that the feet be stressed and ILength prefers that the feet remain stressless.

(44) ILength and MapGM (Ft)

	ILength	MapGM (Ft)
a. $\dots \overset{\mu}{\sigma} \overset{\mu}{\sigma} \overset{\mu}{\sigma} \overset{\mu}{\sigma}$ 		**
b. $\dots \overset{\mu}{\sigma} \overset{x}{\sigma} \overset{\mu}{\sigma} \overset{x}{\sigma}$ 	**	

In (44), both candidates have iambic footing, and the heads of the feet are light. By leaving its feet stressless, candidate (a) is able to satisfy ILength vacuously, but this situation also causes (a) to violate MapGM (Ft). By stressing its feet, candidate (b) is able to satisfy MapGM (Ft), but the foot-level gridmarks have no moraic descent categories within the domain of the foot, so (b) violates ILength.

There are several ways to satisfy ILength, then, and several constraints that might conspire to prevent its satisfaction. When it is highly ranked, the particular manner in which ILength will be satisfied depends on the ranking of the remaining constraints. When MapGM (Ft) is the lowest ranked constraint we can expect the emergence of stressless forms. When Hds-Right is the lowest ranked constraint, we can expect thoroughly trochaic footing similar to that produced by the Trochee constraint in Chapter 4. Finally, when Dep is the lowest ranked, we can expect iambic lengthening. We examine this last option in more detail below.

5.2.2.2 Iambic Lengthening: Choctaw

Following the suggestion in Kager 1995, the proposed account takes at least some iambic lengthening processes to be the result of moraic NonFinality within the foot as produced by the ILength constraint.² When the head of a right-headed foot is associated with a foot-level gridmark, the only way for this foot to satisfy ILength is for its head to have more than one mora. If the foot-level gridmark occurs on any mora but the final, the constraint will be satisfied. For Choctaw and other similar iambic languages, this means adding a mora to the underlyingly monomoraic vowels which occur in stressed syllables on the surface:

(45) Choctaw Underlying and Surface Forms

čipisa	→	čipi:sa
čipisali	→	čipi:sali
čipisačili	→	čipi:sači:li

Although satisfying the ILength constraint is the primary reason for mora insertion in such languages— and for violating the Dep faithfulness constraint that prohibits mora insertion— ILength by itself is not sufficient to produce the desired results. As demonstrated in (41) above, ILength tolerates LH iambs but does not necessarily prefer them over trochees, or even stressless feet. Several rankings are crucial in eliminating these additional options.

As (46) illustrates using the five-syllable /čipi:sači:li/, Hds-Right, MapGM (Ft), and ILength must all rank above Dep. Ranking Hds-Right over Dep ensures that stressed feet cannot be trochaic, as in candidate (d), in order to avoid inserting additional moras, and ranking MapGM (Ft) over Dep ensures that feet cannot remain stressless, as in candidate (c), in order to avoid inserting additional moras. Finally, ranking ILength over Dep ensures that stressed foot-final syllables cannot remain light, as in candidate (b), in order to avoid inserting additional moras.

² The advantages of explaining some instances of iambic lengthening through NonFinality within the syllable will be examined further below.

(46) Hds-Right, MapGM (Ft), ILength >> Dep

čipisačili	Hds-Right	MapGM	ILength	Dep
	* **			**
	* **		*!*	
	* **	*!*		
	* ** **!*			

In (46), candidate (d) drops out first. Although its trochaic footing allows (d) to satisfy MapGM (Ft), ILength, and Dep, it also causes (d) to have more violations of Hds-Right than (a-c). The stressless feet of candidate (c) allow it to satisfy ILength and Dep and to have the best possible rightward foot-head alignment given the length of the form, but (c) drops out because these same feet cause it to have multiple violations of MapGM (Ft) where (a) and (b) have none. Although allowing its stressed, foot-final syllables to remain light allows candidate (b) to satisfy MapGM (Ft) and Dep and to have the best possible rightward foot-head alignment given the length of the form, (b) is eliminated because this same situation causes it to have multiple violations of ILength where (a) has none. Finally, the additional moras in the stressed syllables of candidate (a) cause (a) to have multiple violations of Dep, but they also allow (a) to do well enough on the higher ranked constraints to emerge as the winner.

Notice that it is important in this case, as it was with the Trochee constraint in Chapter 4, that the foot domain referred to by the NonFinality constraint be the foot whose head corresponds to the gridmark. In the intersection of the desired candidate—(a) in (47) below— the shared gridmark is associated with the head of the first foot. Since the vowel in this syllable has been lengthened, the gridmark does not occur on the relevant foot’s final mora, and the ILength constraint is satisfied.

(47) ILength >> Dep

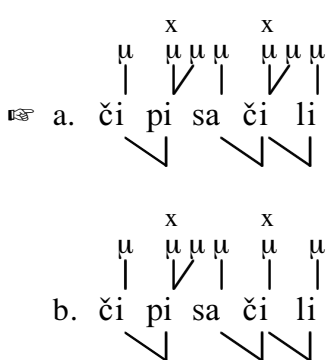
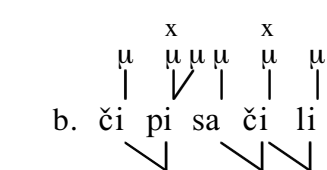
čipisačili	ILength	Dep
 <p>a. č-i pi sa č-i li</p>		**
 <p>b. č-i pi sa č-i li</p>	*!	*

This situation allows candidate (a) to prevail over a candidate like (b), which is identical to (a) except that the vowel associated with the shared gridmark does not lengthen. Since this gridmark is final in the foot whose head it is associated with, candidate (b) violates ILength and is eliminated. If it were possible, however, that the second foot of the intersection could count as the appropriate domain, neither (a) nor (b) would violate ILength, since the shared gridmark does not occur on the final mora of the second foot. The decision would be passed on to Dep, where candidate (b) has the advantage, and (b) would incorrectly emerge as the winner.

To summarize thus far, MNonFinality and ILength both create weight-sensitivity in the sense of stress to weight, as both prohibit stress on light syllables that are final in the relevant domain. In Wergaia, MNonFinality forces a violation of the foot-stress relationship in order to avoid stressing a light prosodic word-final syllable. In Choctaw, ILength forces

mora insertion in order to avoid stressing a light foot-final syllable. We next turn to moraic NonFinality within the syllable, constraints which produce the stress to weight relationship in syllables generally and not just at the edges of larger prosodic domains.

5.2.3 NonFinality within the Syllable

By positing moraic NonFinality constraints within the domain of the syllable, the proposed approach possesses a device whose effect is similar to the Obligatory Branching parameters proposed in Hayes 1981 and Hammond 1986. The two constraints responsible are given in (48).

(48) NonFinality within the Syllable

OBranchFG or NonFin (Ft-GM, Mora, Syll): Every foot-level gridmark has a moraic descent category within the domain of the syllable.

OBranchPG or NonFin (PrWd-GM, Mora, Syll): Every prosodic word-level gridmark has a moraic descent category within the domain of the syllable.

Both OBranchFG and OBranchPG require a moraic descent category within the domain of the syllable for appropriate gridmarks. In other words, they require that the gridmarks not occur on a syllable's final mora. The difference between the two is that OBranchFG makes this requirement for foot-level gridmarks and OBranchPG makes the requirement for prosodic word-level gridmarks.

As (49) demonstrates, there are two ways for a syllable to satisfy OBranchFG. A syllable may be stressless, as in example (b), or it may be bimoraic, as in example (a).

(49) Satisfaction of OBranchFG

	OBranchFG
a. $\begin{array}{c} x \\ \mu \mu \\ \swarrow \searrow \\ \sigma \end{array}$	
b. $\begin{array}{c} \mu \\ \\ \sigma \end{array}$	
c. $\begin{array}{c} x \\ \mu \\ \\ \sigma \end{array}$	*

In example (a), the bimoraic syllable has a foot-level gridmark over its initial mora. Since the gridmark has a moraic descent category within the domain of the syllable, example (a) satisfies OBranchFG. Although example (b) is a monomoraic syllable, it vacuously satisfies OBranchFG, because it has no foot-level gridmarks to require descent categories. Finally, example (c), also a monomoraic syllable, violates OBranchFG because it is associated with a foot-level gridmark and this gridmark does not have a moraic descent category.

Similar considerations allow appropriate syllables to satisfy OBranchPG. As (50) illustrates, a syllable may either occur without a prosodic word-level gridmark, as in candidates (b) and (c), or it may be bimoraic, as in candidate (a).

(50) Satisfaction of OBranchPG

	OBranchPG
x x μ μ ↙ ↘ a. σ	
x μ b. σ	
μ c. σ	
x x μ d. σ	*

In example (a), a bimoraic syllable has a prosodic word-level gridmark over its initial mora. Since the gridmark has a moraic descent category within the domain of the syllable, example (a) satisfies OBranchPG. The example in (b) is a monomoraic syllable with a foot-level gridmark but no prosodic word-level gridmark, and the example in (c) is monomoraic syllable with neither a foot-level gridmark nor a prosodic word-level gridmark. Because there are no prosodic word-level gridmarks in these two examples to require descent categories, both satisfy OBranchPG. Only example (d), a monomoraic syllable with a prosodic word-level gridmark, violates OBranchPG, because the gridmark does not have a moraic descent category.

Because the constraints of (48) require that gridmarks not occur on a syllable's final mora, they essentially demand that, if the head of a foot is to be stressed, it must be bimoraic— it must “branch” in the terms of earlier metrical theory. Although these constraints will allow the proposed approach to mimic the effects of earlier obligatory branching pro-

posals, the effects are actually achieved using a very different set of background assumptions. For example, the proposals of Hayes 1981 and Hammond 1986 both include the use of unbounded feet, and the advantages of the obligatory branching parameter are generally associated with feet of this type. Since unbounded feet are not tolerated in the proposed account, however, these advantages must be obtained through other means. Below, we will explore the most familiar domain of obligatory branching, those unbounded stress systems where syllable weight is a factor. However, we will first examine how NonFinality within the syllable provides a mechanism for producing trochaic lengthening as well as a second mechanism for producing iambic lengthening.

5.2.3.1 Constraint Interactions

Although the OBranch constraints have the ability to produce lengthening effects similar to those of ILength, the OBranch constraints are involved in fewer crucial interactions in this context. The OBranch constraints interact with Dep because Dep might prevent the insertion of moras necessary for descent categories. The OBranch constraints interact with MapGM (Ft) because MapGM (Ft) might insist on stressing light syllables and prevent the OBranch constraints from being satisfied vacuously. The OBranch constraints, however, do not necessarily interact with Hds-Right in this context because the OBranch constraints cannot be satisfied simply by using trochaic feet. It does not matter whether a foot is iambic or trochaic; for the OBranch constraints to be satisfied, stressing the foot means that its head must be heavy.

Although the interaction between OBranch constraints and MapGM (Ft) is important in that it can determine whether or not a form is stressed, I will focus below on the interaction between the OBranch constraints and Dep, which can determine whether or not lengthening occurs. Consider first the competing preferences of OBranchFG and Dep in the context of stressed iambic footing. When the input contains only light syllables,

OBranchFG prefers that the heads of the iambic feet be heavy, and Dep prefers that the heads of the iambic feet be light.

(51) OBranchFG and Dep: Iambs

	LLLL	OBranchFG	Dep
a.			**
b.		**	

In (51), the input is a string of light syllables, and both candidates are footed using stressed iambs. The heads of the iambic feet in candidate (a) are heavy, and the heads of the iambic feet in candidate (b) are light. Because the foot-level gridmarks in the (a) candidate occur over heavy syllables and have moraic descent categories within the domain of the syllable, (a) satisfies OBranchFG. Because the (a) candidate's syllables were made heavy, however, by inserting additional moras, (a) violates Dep. The foot-level gridmarks in candidate (b) have no moraic descent categories, and (b) violates OBranchFG. Since no additional moras have been inserted, however, candidate (b) satisfies Dep.

Consider next the competing preferences of OBranchFG and Dep in the context of trochaic footing. They are identical to the preferences in the context of iambic footing above. When the input contains only light syllables, OBranchFG prefers that the heads of trochaic feet be heavy, and Dep prefers that the heads of trochaic feet be light.

(52) OBranchFG and Dep: Trochees

LLLL	OBranchFG	Dep
<p>a. </p>		**
<p>b. </p>	**	

In (52), the input is a string of light syllables, and both candidates are footed using stressed trochees. The heads of the feet in candidate (a) are heavy, and the heads of the feet in candidate (b) are light. The gridmarks in candidate (a) each have a moraic descent category with the domain of the syllable so that (a) satisfies OBranchFG, but because candidate (a) contains moras that were not present in the input, it violates Dep. Since candidate (b) does not have any additional moras it satisfies Dep, but its gridmarks do not have moraic descent categories within the syllable, violating OBranchFG.

When OBranchFG ranks over Dep, then, the heads of stressed feet must lengthen regardless of whether these feet are iambic or trochaic. In the discussion that follows we will examine this interaction in languages of both types.

5.2.3.2 Iambic Lengthening: Hixkaryana

Just as the head of an iambic foot must be bimoraic if its stress is to be non-final in the foot, the head of an iambic foot must be bimoraic if its stress is to be non-final in the syllable. The OBranchFG constraint, then, provides a second mechanism for obtaining iambic lengthening, but it differs from the previous iambic lengthening constraint, ILength, in also being able to produce lengthening in trochaic feet. This difference is crucial in obtaining the lengthening pattern of Hixkaryana:

(53) Hixkaryana Underlying and Surface Forms

kwaya	→	kwa:ya	<i>red and green macaw</i>
torono	→	toro:no	<i>small bird</i>
atxowowo	→	atxo:wowo	<i>wind</i>
nemokotono	→	nemo:koto:no	<i>it fell</i>

Recall from the discussion above that, in larger-than-disyllabic forms, Hixkaryana displays the same basic even offbeat pattern as Choctaw, a pattern produced by the ranking repeated in (54) below.

(54) Even Offbeat Ranking

SNonFinality, Hds-Right >> MapGM (Ft)

Stress occurs on every even-numbered syllable, except the final, meaning that the final foot is stressless in even-parity forms. Also as in Choctaw, Hixkaryana lengthens the vowels of stressed, open syllables.

In disyllabic forms, however, where there was no lengthening in Choctaw and apparently no stress, Hixkaryana stresses and lengthens the initial syllable. In other words, Hixkaryana's disyllabic forms follow the even downbeat pattern in reversing the type of the final foot— in this case, the only foot— from iambic to trochaic, and then the head of this trochaic foot is lengthened. The question is why a final foot behaves differently when it is also the only foot in the form, and the answer I will propose is that it behaves differently because it is the only foot available to carry primary stress. It should be noted that Derbyshire describes primary stress as always occurring on the prosodic word-final syllable, but Hayes (1995) points out that what Derbyshire describes as the primary stress is intonationally governed and not dependent on an individual word's metrical structure. This being the case, I will assume that Derbyshire's primary stress is not the same phenomenon as the prosodic word-level gridmark.

Assuming for Hixkaryana that a prosodic word-level gridmark must occur in every form, a high ranking SNonFinality constraint will force this gridmark to occur on the initial

syllable in disyllabic forms at the expense of Hds-Right. As illustrated using the two-syllable /kwa:ya/ in (55), the ranking from (54) must be clarified and expanded so that MapGM (PrWd) and SNonFinality rank above Hds-Right. Ranking MapGM (PrWd) above Hds-Right ensures that the prosodic word-level gridmark will not be absent, as in candidate (c), in order to allow better rightward foot-head alignment, and ranking SNonFinality above Hds-Right ensures that the prosodic word-level gridmark will not be associated with the final syllable, as in candidate (b), in order to allow better rightward foot-head alignment.

(55) MapGM (PrWd), SNonFinality >> Hds-Right

kwaya	MapGM (PrWd)	SNonFinality	Hds-Right
x x a. kwaya ✓			*
x x b. kwaya ✓		*!	
c. kwaya ✓	*!		

In (55), candidate (c) drops out first. Although the absence of a prosodic word-level gridmark (and its supporting foot-level gridmark) allows candidate (c) to satisfy both SNonFinality and Hds-Right, it also causes (c) to violate MapGM (PrWd) where (a) and (b) do not. The position of its primary stress allows candidate (b) to satisfy both MapGM (PrWd) and Hds-Right, but (b) drops out because the supporting foot-level gridmark occurs on the final syllable, violating SNonFinality where candidate (a) does not. Although the position of its prosodic word-level gridmark causes candidate (a) to incur a violation of Hds-Right, it also

allows (a) to perform well enough on SNonFinality and MapGM (PrWd) to emerge as the winner.

Since primary stress can be associated with a foot other than the final in larger-than-disyllabic forms, they are not affected by the revised ranking from (55). In these forms, all feet are iambic, and ranking OBranchFG and MapGM (Ft) over Dep produces the same type of iambic lengthening configuration that was produced by ranking ILength and MapGM (Ft) over Dep in the discussion of Choctaw above. As (56) illustrates using the five-syllable /nemo:koto:no/, NonFinality within the syllable means lengthening the stressed heads of iambic feet.

(56) Larger-than-Disyllabic Forms: MapGM (Ft), OBranchFG >> Dep

nemokotono	MapGM (Ft)	OBranchFG	Dep
a.			**
b.		*!*	
c.	*!***		

In (56), the input contains only monomoraic vowels. The (a) candidate is footed using stressed iambs with heavy heads, the (b) candidate is footed using stressed iambs with light heads, and the (c) candidate is footed using stressless iambs with light heads. Candidate (c) satisfies Dep because it does not have any moras that were absent in the input, and it vacuously satisfies OBranchFG because it is stressless. Candidate (c) drops out, however, be-

cause it violates MapGM (Ft) where (a) and (b) do not. The monomoraic vowels of candidate (b) allow it to satisfy Dep, and because its feet are stressed it satisfies MapGM (Ft). Candidate (b) is eliminated because its foot-level gridmarks do not have moraic descent categories within the syllable, causing it to violate OBranchFG where (a) does not. Although its bimoraic vowels cause candidate (a) to violate Dep, they also allow its foot-level gridmarks to have moraic descent categories within the syllable. Since (a) performs better on the higher ranked constraints, it is the winner.

Unlike the ILength constraint, the lengthening effects of OBranchFG are not limited to right-headed feet. Since the lengthening is to provide a moraic descent category within the syllable rather than within the foot, lengthening will occur whether the stressed syllable is the head of an iambic foot, a monosyllabic foot, or a trochaic foot. As (57) illustrates using /kwa:ya/, this allows the proposal to obtain the lengthening of the initial syllable in disyllabic trochaic forms with the same mechanism that obtained the lengthening of the longer iambic forms in (56). Recall that with disyllabic forms, however, MapGM (PrWd) is the crucial MapGridmark constraint.

(57) Disyllabic Forms: MapGM (PrWd) >> OBranchFG >> Dep

kwaya	MapGM (PrWd)	OBranchFG	Dep
<p>a. kwaya</p>			*
<p>b. kwaya</p>		*!	
<p>c. kwaya</p>	*!		

In (57), the input contains only monomoraic vowels. Each candidate consists of a single trochaic foot. The head of the foot in the (a) candidate is stressed and heavy, the head of the foot in the (b) candidate is stressed and light, and the head of the foot in the (c) candidate is stressless and light. The stressless monomoraic head of candidate (c) allows it to satisfy Dep and to vacuously satisfy OBranchFG, but (c) drops out because it violates MapGM (PrWd) where (a) and (b) do not. The monomoraic vowel of candidate (b) allows it to satisfy Dep, but it also causes (b) to drop out at OBranchFG, because its supporting foot-level gridmark does not have a moraic descent category within the syllable. Although its bimoraic vowel causes candidate (a) to violate Dep, it also allows this candidate's foot-level gridmark to have a moraic descent category within the syllable. Since candidate (a) performs better on the higher ranked constraints, it is the winner.

Unlike ILength, then, which can only lengthen the stressed heads of iambs and monosyllables, OBranchFG can also produce lengthening in the stressed heads of trochees.

This circumstance allows a uniform explanation of lengthening in languages like Hixkaryana, where stressed syllables must be bimoraic, but both iambic and trochaic configurations occur. The final Hixkaryana ranking is summarized in (58).

(58) Final Hixkaryana Ranking

MapGM (PrWd), SNonFinality >> Hds-Right >> MapGM (Ft), OBranchFG >> Dep

As we shall see below, OBranchFG also allows the proposal to obtain lengthening in languages whose footing is thoroughly trochaic.

5.2.3.3 Trochaic Lengthening: Chimalapa Zoque

Although apparently less frequently than in iambic systems, lengthening of stressed syllables also occurs in trochaic systems. Examples of such systems include Icelandic (Arnason 1980, 1985), Mohawk (Michelson 1988), and Chimalapa Zoque (Knudson 1975). Since we have already examined the stress pattern of Chimalapa Zoque in some detail in Chapter 4, I will use it here to demonstrate trochaic lengthening as well. Example contrasts between underlying and surface forms are given in (59).

(59) Chimalapa Zoque Underlying and Surface Forms

minpa	→	mínpa
hukuti	→	hù:kú:ti
minsukke?tpa	→	mìnsukké?tpa
witu?payníksi	→	wìtu?payníksi

As illustrated in (59), stress occurs in Chimalapa Zoque on the initial syllable and on the penult. Notice that underlyingly short vowels that are stressed on the surface lengthen when they occur in open syllables but not when they occur in closed syllables.

As (60) demonstrates using /hù:kú:ti/, ranking OBranchFG over Dep ensures that the underlying short vowels of stressed open syllables lengthen, even though these syllables are the heads of trochaic feet.

(60) Open Syllables: OBranchFG >> Dep

	hukuti	OBranchFG	Dep
a.			**
b.		*!	

In (60), the first and second syllables of both candidates are the heads of trochaic feet. Both syllables are open, and both are stressed. The difference between the two candidates is in the length of the vowels that occupy these syllables. In candidate (b) the vowels are monomoraic, as they were underlyingly, but in candidate (a) the vowels are bimoraic. Since moras have not been added to its vowels, candidate (b) satisfies Dep. Since these same vowels are monomoraic, however, their associated foot-level gridmarks do not have moraic descent categories within the syllable, and candidate (b) is eliminated because it violates OBranchFG where (a) does not. Although its lengthened bimoraic vowels cause candidate (a) to violate Dep, they also allow their associated foot-level gridmarks to have moraic descent categories within the syllable. Since (a) performs better on the higher ranked constraint, it is the winner.

The absence of vowel lengthening in stressed closed syllables is due to the fact that these syllables are already bimoraic and already provide moraic descent categories for their associated foot level gridmarks. As demonstrated using /mínpa/ in (61) below, lengthening is avoided in such cases because it results in unnecessary Dep violations.

(61) Closed Syllables: OBranchFG >> Dep

minpa	OBranchFG	Dep
<p>a. mi n pa</p>		
<p>b. mi n pa</p>		*!

In (61), the single stress in both candidates occurs on the initial closed syllable. The difference between the two candidates is in the length of the vowel belonging to this syllable. In candidate (b), the vowel is bimoraic, but in candidate (a), the vowel is monomoraic. Since the stressed syllables in both (a) and (b) are able to provide moraic descent categories for their associated foot-level gridmarks, both candidates satisfy this constraint, and the decision between them is passed on to Dep. Because its lengthened vowel causes candidate (b) to violate Dep where candidate (a) does not, (b) is eliminated, and (a) emerges as the winner.

OBranchFG, then, provides a mechanism for obtaining lengthening in trochaic systems as well as a second method for obtaining lengthening in iambic systems. It is also worth noting that the relative rarity of trochaic lengthening as compared to iambic lengthening might be expected due to the fact that there are more mechanisms for producing the latter than there are for producing the former.

5.3 Unbounded Stress Systems

We now turn to weight-sensitive unbounded stress systems, a more familiar domain for obligatory branching effects. In these systems, a string of light syllables will have a single stress at one edge or the other of the prosodic word, but a string that includes heavy syllables may find its stress moved away from the designated edge.³ Such systems come in two general types, the labels for these being taken from Prince 1985. “Defaults to same side” systems have stress on the heavy syllable nearest a designated edge or, in absence of a heavy syllable, on the light syllable nearest the same edge. “Defaults to opposite side” systems have stress on the heavy syllable nearest a designated edge or, in absence of a heavy syllable, on the light syllable nearest the opposite edge. As we shall see below, Non-Finality within the syllable plays a crucial role in the analysis of both types.

5.3.1 Defaults to Same Side

At the core of the proposed rankings for weight-sensitive unbounded systems are the rankings for weight-insensitive unbounded systems. These were discussed in Chapter 3 and are repeated in (62) and (63) below.

(62) Left-Oriented, Weight-Insensitive Ranking

MapGM (PrWd), FG-Left >> FG-Right

(63) Right-Oriented, Weight-Insensitive Ranking

MapGM (PrWd), FG-Right >> FG-Left

Recall that the ranking in (62) ensured a single gridmark column at the left edge of the prosodic word and that the ranking in (63) ensured a single gridmark column at the right edge of the prosodic word.

³ I am distinguishing here between systems described as having a single, primary stress and systems where every heavy syllable receives at least a secondary stress— such as Kuuku-Ya?u (Thompson 1976), Khalka Mongolian (Street 1963, Bosson 1964, Poppe 1970, and Walker 1996), and Buriat (Poppe 1960 and Walker 1996). The latter type can be straightforwardly analyzed along the lines of Bakovic 1998, but the former cannot without also assuming that heavy syllables always have secondary stress in these systems as well.

The most crucial interactions involving OBranch constraints in this context are between OBranchPG and the highest ranked of the gridmark alignment constraints in (62) and (63). In the case of the left-oriented ranking (62), the crucial interaction is between OBranchPG and FG-Left. In the case of the right-oriented ranking (63), the crucial interaction is between OBranchPG and FG-Right. Consider first in (64) the conflicting preferences of OBranchPG and FG-Left when the competition is between candidates containing a heavy syllable. OBranchPG prefers that stress occur over the heavy syllable, and FG-Left prefers that stress occur over the leftmost syllable. Consider also in (65) the non-conflicting preferences of OBranchPG and FG-Left when the competition is between candidates without a heavy syllable. Both OBranchPG and FG-Left agree on stressing the leftmost syllable.

(64) OBranchPG and FG-Left: Heavy Syllable Present

	OBranchPG	FG-Left
<p>a.</p>		**
<p>b.</p>	*	

In (64), both candidates are five syllable prosodic words. The third syllable in each candidate is heavy. Since the prosodic word-level gridmark occurs over the heavy syllable in candidate (a), (a) satisfies OBranchPG, but because the supporting foot-level gridmark occurs away from the left edge, (a) has more violations of FG-Left than candidate (b). Since the supporting foot-level gridmark is at the left edge in candidate (b), (b) performs better on FG-Left, but because the prosodic word-level gridmark occurs over a light syllable, candi-

date (b) violates OBranchPG. OBranchPG prefers candidate (a), but FG-Left prefers candidate (b).

(65) OBranchPG and FG-Left: No Heavy Syllable Present

	OBranchPG	FG-Left
a. $\begin{array}{ccccc} & & x & & \\ & & x & & \\ \mu & \mu & \mu & \mu & \mu \\ & & & & \\ \sigma & \sigma & \sigma & \sigma & \sigma \end{array}$	*	**
b. $\begin{array}{ccccc} x & & & & \\ x & & & & \\ \mu & \mu & \mu & \mu & \mu \\ & & & & \\ \sigma & \sigma & \sigma & \sigma & \sigma \end{array}$	*	

In (65), each candidate is a five-syllable prosodic word where all of the syllables are light. Since neither candidate has its prosodic word-level gridmark over a light syllable, both violate OBranchPG, and OBranchPG does not prefer one over the other. Because the supporting foot-level gridmark of candidate (b) occurs at the left edge and the supporting foot-level gridmark of candidate (a) occurs medially, FG-Left prefers candidate (b) over candidate (a). The two constraints can agree, then, on candidate (b).

Consider next in (66) the conflicting preferences of OBranchPG and FG-Right when the competition is between candidates with a heavy syllable. OBranchPG prefers that stress occur over the heavy syllable, and FG-Right prefers that stress occur over the rightmost syllable. Consider also in (67) the non-conflicting preferences of OBranchPG and FG-Right when the competition is between candidates without a heavy syllable. Both constraints can agree on stressing the rightmost syllable.

(66) OBranchPG and FG-Right: Heavy Syllable Present

	OBranchPG	FG-Right
<p>a.</p> <pre> x x μ μ μ μ μ σ σ σ σ σ </pre>		***
<p>b.</p> <pre> x x μ μ μ μ μ σ σ σ σ σ </pre>	*	

In (66), both candidates are five-syllable prosodic words, and the third syllable in each is heavy. Because candidate (a) positions its prosodic word-level gridmark over the heavy syllable, it satisfies OBranchPG, but because the supporting foot-level gridmark is away from the right edge, candidate (a) has more violations of FG-Right than candidate (b). Candidate (b) positions its supporting foot-level gridmark over the rightmost syllable, allowing it to satisfy FG-Right, but because the rightmost syllable is light, candidate (b) violates OBranchPG. OBranchPG prefers candidate (a), but FG-Right prefers candidate (b).

(67) OBranchPG and FG-Right: No Heavy Syllable Present

	OBranchPG	FG-Right
<p>a.</p> <pre> x x μ μ μ μ μ σ σ σ σ σ </pre>	*	***
<p>b.</p> <pre> x x μ μ μ μ μ σ σ σ σ σ </pre>	*	

In (67), both candidates are again five-syllable prosodic words, but none of the syllables is heavy. Because both candidates position their prosodic word-level gridmarks over light syllables, both violate OBranchPG. Candidate (b), which positions its supporting foot-level

gridmark at the right edge, performs better on FG-Right than candidate (a), which positions its supporting foot-level gridmark medially. Both constraints can agree, then, on candidate (b).

To convert the systems produced by the (62) and (63) rankings into weight-sensitive systems, it is necessary simply to circumscribe the demands of gridmark alignment through NonFinality within the syllable. Two modifications are required to accomplish this result. First, MapGM (PrWd) must be crucially ranked above the dominant gridmark alignment constraints, and second, OBranchPG must be introduced and ranked above the dominant gridmark alignment constraints, as well:

(68) Left-Oriented, Weight-Sensitive Ranking

MapGM (PrWd), OBranchPG >> FG-Left >> FG-Right

(69) Right-Oriented, Weight-Sensitive Ranking

MapGM (PrWd), OBranchPG >> FG-Right >> FG-Left

As we shall see below, the ranking in (68) ensures that primary stress will move away from the left edge if doing so will allow it to occur on a heavy syllable, and the ranking in (69) ensures that primary stress will move away from the right edge if doing so will allow it to occur on a heavy syllable.

Before exploring these effects more fully, however, it should be noted that languages presented as weight-sensitive, defaults-to-same-side systems often are not totally convincing in this classification. For example, the stress patterns of Amele (Roberts 1987) and Murik (Abbott 1985) are both described as having stress on the first heavy syllable, or in the absence of a heavy syllable, on the first syllable. However, since there is never more than one heavy syllable per form on the surface in these languages (and no clear evidence of additional heavy syllables underlyingly), it is not really possible to tell whether it is being the first, the last, or some other designation that causes the heavy syllables to be stressed. Similarly, the stress pattern of Aguacatec (McArthur and McArthur 1956) is described as having stress on the last heavy syllable, or in the absence of a heavy syllable, on the last syllable.

Since McArthur and McArthur do not demonstrate the pattern for forms with more than one heavy syllable, however, the importance of being the last heavy syllable is less than clear.

Since the primary aim of the following discussion is to show how NonFinality within the syllable introduces weight-sensitivity to unbounded systems and can cause stress to move away from a default edge, the lack of certainty about the classification of the example languages need not concern us here. Murik will be used to illustrate a left-oriented, defaults-to-same-side system, and Aguacatec will be used to illustrate a right-oriented, defaults-to-same-side system. After examining these basic patterns, we will examine patterns in two additional languages to see how defaults-to-same-side systems can be affected by other considerations. Western Cheremis (Itkonen 1955) will be used to illustrate a defaults-to-same-side system circumscribed by NonFinality in the prosodic word, and Latin will be used to illustrate a defaults-to-same-side system circumscribed by a trisyllabic stress window.

5.3.1.1 Leftward Default: Murik

As mentioned above, Murik (Abbott 1985) is considered to be a left-oriented, defaults-to-same-side system:

(70) Murik Forms (Abbott 1985)

́L	dámag	<i>garden</i>
́LL	dák ^h animp	<i>post</i>
́HL	sá:k ^h o	<i>wait</i>
ĹH	gaí:n	<i>canoe</i>
LLĹH	anənp ^h aré:t ^h	<i>lightning</i>
LĹHL	numaró:go	<i>woman</i>

As (70) illustrates, stress in Murik occurs on the leftmost heavy syllable, or in the absence of a heavy syllable, on the leftmost syllable. Heavy syllables are CV:

The key to obtaining defaults-to-same-side patterns is to require the single gridmark column in each form to move away from the default edge if doing so will allow the prosodic

word-level gridmark to occur over a heavy syllable and, thus, to be non-final within that syllable. For left-oriented Murik, this means requiring the gridmark column to move away from the left edge if a heavy syllable is present in the form. As (71) illustrates using [numaró:go], the ranking from (68) above produces the desired result. Ranking MapGM (PrWd) over FG-Left ensures that the prosodic word-level gridmark will not be absent, as in candidate (c), in order to maintain the best possible leftward gridmark alignment, and ranking OBranchPG over FG-Left ensures that the prosodic word-level gridmark will not occur over a light syllable, as in candidate (b), in order to preserve the best possible leftward gridmark alignment.

(71) MapGM (PrWd), OBranchPG >> FG-Left

numaró:go	MapGM (PrWd)	OBranchPG	FG-Left
<pre> x x μ μ μ μ μ / a. nu ma ro go </pre>			**
<pre> x x μ μ μ μ μ / b. nu ma ro go </pre>		*!	
<pre> x μ μ μ μ μ / c. nu ma ro go </pre>	*!		

In (71), the third syllable of each candidate is heavy, and the first, second, and fourth syllables are light. Candidate (c), which occurs without a prosodic word-level gridmark, drops out first. Although the absence of a prosodic word-level gridmark allows candidate (c) to have stress on the light initial syllable without violating OBranchPG, it also causes (c) to violate MapGM (PrWd) where (a) and (b) do not. Next, the position of its prosodic word-

level gridmark allows candidate (b) to satisfy FG-Left, but (b) drops out because the gridmark occurs over a light syllable and does not have a moraic descent category within the syllable, violating OBranchPG where (a) does not. Although the position of its gridmark column over the heavy syllable causes candidate (a) to perform worse with respect to FG-Left than either (b) or (c), it allows (a) to do well enough on the higher ranked constraints to emerge as the winner.

The ranking in (71), then, has the desired effect of moving stress away from a light syllable at the default edge and onto a heavy syllable. It is also important to demonstrate, however, that this same ranking produces canonical defaults-to-same-side systems in that they restrict movement to the minimal distance necessary for locating a heavy syllable. In other words, as (72) demonstrates, if a form were to occur in Murik with two or more heavy syllables on the surface, the (71) ranking predicts that stress would fall on the heavy syllable closest to the left edge.

(72) Left-Oriented: MapGM (PrWd), OBranchPG >> FG-Left

	LHLH	MapGM (PrWd)	OBranchPG	FG-Left
a.	$ \begin{array}{cccc} & & x & \\ & & x & \\ \mu & \mu & \mu & \mu \\ & \vee & & \vee \\ \sigma & \sigma & \sigma & \sigma \end{array} $			*
b.	$ \begin{array}{cccc} & & & x \\ & & & x \\ \mu & \mu & \mu & \mu \\ & \vee & & \vee \\ \sigma & \sigma & \sigma & \sigma \end{array} $			**! **

In (72), the second and fourth syllables of both candidates are heavy, and the first and third are light. The difference between the two is that the gridmark column occurs over the second syllable in candidate (a) and over the fourth syllable in candidate (b). Since both candidates have prosodic word-level gridmarks, they perform equally well with respect to MapGM (PrWd), and since the prosodic word-level gridmarks of both candidates have moraic de-

scent categories within the syllable, they perform equally well with respect to OBranchPG. Because the supporting foot-level gridmark of candidate (a) is closer to the left edge than that of candidate (b), however, (b) drops out at FG-Left, and (a) emerges as the winner.

If more than one heavy syllable, then, were present in a form, the (71/72) ranking would place stress on the heavy syllable closest to the left edge. What remains to be demonstrated is that this same rankings maintain stress at the left edge in forms with only light syllables. As (73) illustrates using [dák^hanimp], MapGM (PrWd) and OBranchPG do not distinguish between different positions for gridmark columns in these forms, meaning that the decision is left to FG-Left.

(73) Left-Oriented: MapGM (PrWd), OBranchPG >> FG-Left

dak ^h animp	MapGM (PrWd)	OBranchPG	FG-Left
x x μ μ μ a. dak ^h animp		*	
x x μ μ μ b. dak ^h animp		*	*!

In (73), both candidates consist of four light syllables, the difference between them being that the gridmark column of candidate (a) occurs over the first syllable where the gridmark column of candidate (b) occurs over the second. Since both candidates have prosodic word-level gridmarks, both satisfy MapGM (PrWd), and since the prosodic word-level gridmark of neither candidate has a moraic descent category within the syllable, both violate OBranchPG. Neither of the two higher ranked constraints, then, distinguish between a column at the left edge and a column away from the left edge, and the decision is passed on to

FG-Left. Because the gridmark column of candidate (a) is closer to the left edge than that of candidate (b), (a) incurs fewer violations and correctly emerges as the winner.

5.3.1.2 Rightward Default: Aguacatec

Aguacatec (McArthur and McArthur 1956) is considered to be a right-oriented, defaults-to-same-side system:

(74) Aguacatec Forms (McArthur and McArthur 1956)

Ĺ	kaʔpén	<i>day after tomorrow</i>
LĹ	tʃinholíh-ts	<i>they search for me</i>
LH́	ʔintá:	<i>my father</i>
HL	mí:tuʔ	<i>cat</i>

As (74) illustrates, stress in Aguacatec occurs on the rightmost heavy syllable, or in the absence of a heavy syllable, on the rightmost syllable. Heavy syllables are CV:.

For the right-oriented Aguacatec, the gridmark column must be required to move away from the right edge if a heavy syllable is present in the form, and as (75) illustrates using [mí:tuʔ], the ranking from (69) above produces the desired result. Ranking MapGM (PrWd) over FG-Right ensures that the prosodic word-level gridmark will not be absent, as in candidate (c), in order to maintain the best possible rightward gridmark alignment, and ranking OBranchPG over FG-Right ensures that the prosodic word-level gridmark will not occur over a light syllable, as in candidate (b), in order to preserve the best possible leftward gridmark alignment.

(75) MapGM (PrWd), OBranchPG >> FG-Right

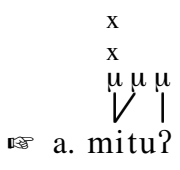
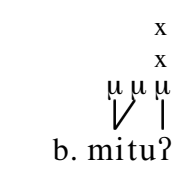
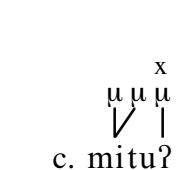
mi:tu?	MapGM (PrWd)	OBranchPG	FG-Right
 <p>a. mi:tu?</p>			**
 <p>b. mi:tu?</p>		*!	
 <p>c. mi:tu?</p>	*!		

In (75), the first syllable of each candidate is heavy and the second syllable is light. Candidate (c) drops out first. Although the absence of the prosodic word-level gridmark allows candidate (c) to have stress on the final syllable without violating OBranchPG, it also causes (c) to violate MapGM (PrWd) where (a) and (b) do not. Candidate (b) drops out next. The position of its prosodic word-level gridmark allows candidate (b) to satisfy FG-Right, but because this positioning places the gridmark over a light syllable, (b) violates the higher ranked OBranchPG where (a) does not. Finally, although the position of its gridmark column over the heavy syllable causes candidate (a) to perform worse than either (b) or (c) with respect to FG-Right, it allows (a) to do well enough on the higher ranked constraints to emerge as the winner.

Next, as (76) demonstrates, if a form were to occur in Aguacatec with two or more heavy syllables on the surface, the (75) ranking also predicts that stress would fall on the heavy syllable closest to the right edge.

(76) Right-Oriented: MapGM (PrWd), OBranchPG >> FG-Right

	LHLH	MapGM (PrWd)	OBranchPG	FG-Right
a.	$ \begin{array}{cccc} & & & x \\ & & & x \\ & \mu & \mu & \mu & \mu & \mu & \mu \\ & \vee & & \vee & \\ \sigma & \sigma & \sigma & \sigma \end{array} $			* *
b.	$ \begin{array}{cccc} & & & x \\ & & & x \\ & \mu & \mu & \mu & \mu & \mu \\ & \vee & & \vee & \\ \sigma & \sigma & \sigma & \sigma \end{array} $			***!***

In (76), the first and third syllables of both candidates are heavy, and the second and fourth syllables are light. The difference between them is that the gridmark column occurs over the third syllable in candidate (a) and over the first syllable in candidate (b). As both candidates satisfy the two higher ranked constraints, the decision is passed on to FG-Right, and since the gridmark column of (a) occurs closer to the right edge than the gridmark column of (b), candidate (a) emerges as the winner.

Finally, as (77) demonstrates using [tʃinohjɫih-ts], MapGM (PrWd) and OBranchPG do not distinguish between different positions for gridmark columns in forms with only light syllables. The decision about where to position the gridmark column is left to FG-Right.

(77) Right-Oriented: MapGM (PrWd), OBranchPG >> FG-Right

tʃinholjih-ts	MapGM (PrWd)	OBranchPG	FG-Right
<p>a.tʃinholjih-ts</p>		*	
<p>b.tʃinholjih-ts</p>		*	*!

In (77), each candidate consists of three light syllables, the difference between the two being that the gridmark column of candidate (a) occurs over the third where the gridmark column of candidate (b) occurs over the first. As the candidates perform equally on the two higher ranked constraints, the decision is passed on to FG-Right, and since the gridmark column of (a) is closer to the right edge than the gridmark column of (b), candidate (a) correctly emerges as the winner.

We have seen in the discussion of Aguacatec and in the discussion of Murik above how NonFinality within the syllable can introduce weight-sensitivity to unbounded stress systems, producing both left-oriented and right-oriented defaults-to-same-side patterns. The preference for prosodic word-level gridmarks to have a moraic descent category within the syllable provides a reason for gridmark columns to move away from the designated edge of gridmark alignment when heavy syllables are present in a form. Below, we will see how such systems can be influenced by Window and NonFinality constraints within the domain of the prosodic word, allowing the proposal to produce patterns like the ones exhibited by Western Cheremis (Itkonen 1955) and Latin.

5.3.1.3 Western Cheremis

Western Cheremis (Itkonen 1955) is a right-oriented, defaults-to-same-side language limited by NonFinality within the prosodic word.

(78) Western Cheremis Forms (Itkonen 1955)

ĹLL	pərə́ʃəm	<i>I went in</i>
ĹLH	əməl'tem	<i>I throw my shade on</i>
́HLL	kórnəʃtə	<i>road (inessive)</i>
́HLH	βáʃtəlam	<i>I laugh</i>
H́HL	oʃmáʃtə	<i>sand (inessive)</i>

As (78) illustrates, stress in Western Cheremis falls on the rightmost non-final syllable containing a full vowel and, in the absence of a non-final syllable containing a full vowel, on the rightmost non-final syllable. For our purposes here, I will assume that the full vowels [e, o, a] are always bimoraic and that the reduced vowel [ə] is always monomoraic.

Despite its rightward orientation, then, stress in Western Cheremis never actually occurs on a form's rightmost syllable, so that the domain of the mechanisms producing the defaults-to-same-side system must be limited pre-final syllables. To obtain this situation, the core of the Western Cheremis ranking, the same as the ranking given for Aguacatec above, must be dominated by SNonFinality:

(79) Western Cheremis Ranking

SNonFinality, MapGM (PrWd) >> OBranchPG >> FG-Right

By ranking SNonFinality above both FG-Right and OBranchPG, stress will be banned from the final syllable whether it is light or heavy and even if it is the only heavy syllable in the form.

As (80) demonstrates using [əməl'tem], ranking SNonFinality over OBranchPG ensures that the gridmark column cannot occur over the form's final syllable, as in candidate (b), in order for the prosodic word-level gridmark to have a moraic descent category within the syllable. Ranking SNonFinality over FG-Right ensures that the gridmark column

cannot occur over the form's final syllable, again as in candidate (b), in order for the supporting foot-level gridmark to be nearer the right edge. (Only candidates that satisfy MapGM (PrWd) are considered in this and the following two tableaux.)

(80) SNonFinality >> OBranchPG >> FG-Right

	əməltəm	SNonFinality	OBranchPG	FG-Right
a.	$ \begin{array}{c} x \\ x \\ \mu \quad \mu \quad \mu \mu \\ \quad \quad / \\ \text{ə} \quad \text{mə} \quad \text{təm} \end{array} $		*	**
b.	$ \begin{array}{c} x \\ x \\ \mu \quad \mu \quad \mu \mu \\ \quad \quad / \\ \text{ə} \quad \text{mə} \quad \text{təm} \end{array} $	*!		*

In (80), the first and second syllables of both candidates are heavy and the third is light. The difference between them is that the gridmark column of candidate (a) occurs over the penultimate syllable where the gridmark column of candidate (b) occurs over the final syllable. Although the position of its gridmark column over the heavy final syllable allows candidate (b) to satisfy OBranchPG and to perform better than (a) with respect to FG-Right, it also causes (b) to violate SNonFinality where (a) does not. The position of its gridmark column over the light penult causes (a) to violate OBranchPG and to have more violations of FG-Right than candidate (b), but it also allows (a) to satisfy the higher ranked SNonFinality and, thus, to emerge as the winner.

The position of SNonFinality in the ranking, then, serves to limit the occurrence of stress to pre-final syllables. The lower ranked OBranchPG and FG-Right, however, still have a great deal of influence within these boundaries. For [əməltəm], limiting stress to the pre-final syllables means limiting stress to a string of light syllables, and Western Cheremis behaves like a right-oriented, defaults-to-same-side system in this circumstance. Stress occurs on the rightmost available syllable— the penult. To illustrate, when we consider an ad-

ditional competitor for [əməltəm] in (81), we can see that the demands of FG-Right ensure that the gridmark column does not occur further to the left than necessary for satisfying SNonFinality.

(81) SNonFinality >> OBranchPG >> FG-Right

	əməltəm	SNonFinality	OBranchPG	FG-Right
a.	<pre> x x μ μ μ μ / ə məl tɛm </pre>		*	**
b.	<pre> x x μ μ μ μ / ə məl tɛm </pre>		*	***!

The difference between the two candidates in (81) is that the gridmark column in (a) occurs over the penult where the gridmark column in (b) occurs over the initial syllable. Because the column of neither candidate occurs over the final syllable, both satisfy SNonFinality, and because the column of both candidates occurs over a light syllable, both violate OBranchPG. Since the two higher ranked constraints do not distinguish between the candidates, the decision is passed on to FG-Right. As the supporting foot-level gridmark of candidate (a) is closer to the right edge than the supporting foot-level gridmark of candidate (b), (a) better satisfies FG-Right and correctly emerges as the winner.

When the string of pre-final syllables includes a heavy syllable, Western Cheremis behaves like a right-oriented, defaults-to-same-side system. Stress occurs on the rightmost available heavy syllable. As (82) demonstrates using [βáʔtəlam], ranking OBranchPG over FG-Right ensures that the gridmark column does not occur over a light syllable, as in candidate (b), in order to allow the supporting foot-level gridmark to be nearer the right edge.

(82) SNonFinality >> OBranchPG >> FG-Right

βaftəlam	SNonFinality	OBranchPG	FG-Right
<p>a. βaftəlam</p>			****
<p>b. βaftəlam</p>		*!	**

In (82), the first and third syllables of both candidates are heavy, and the second syllable is light. The difference between them is that the gridmark column of candidate (a) occurs over the heavy initial syllable where the gridmark column of candidate (b) occurs over the light penultimate syllable. Since the gridmark column of neither candidate occurs over its final syllable, both satisfy SNonFinality, and the decision is passed on to OBranchPG. The position of its gridmark column over the light penult in (b) allows it to satisfy FG-Right as well as possible given the demands of SNonFinality, but it also causes (b) to violate OBranchPG where (a) does not. Although the position of its gridmark column over the heavy initial syllable causes candidate (a) to have more violations of FG-Right, it also allows (a) to satisfy the higher ranked OBranchPG and, thus, to emerge as the winner.

5.3.1.4 Latin

Latin is similar to Western Cheremis in that primary stress is the result of a weight-sensitive defaults-to-same-side system circumscribed by SNonFinality. There are two important differences, however. First, Latin is left-oriented where Western Cheremis is right-oriented. Second, stress in Latin is also circumscribed by a trisyllabic stress window at the right edge of the prosodic word. Primary stress in Latin is typically described as follows. In disyllabic

forms, stress occurs on the penult. In larger-than-disyllabic forms, stress occurs on the penult if it is heavy, otherwise on the antepenult:

(83) Latin Forms

́LLH	símula:
ĹHH	amí:kus
́́LLH	komítium
ĹHLH	doméstikus
LHH́H	mone:bá:mus
H́́LLH	partikípium

Though simple and accurate, the typical description obscures Latin's status as a defaults-to-same-side system. A more revealing description would be that primary stress occurs on the leftmost non-final heavy syllable within the limits of the stress window, or in the absence of such a heavy syllable on the leftmost light syllable within the limits of the stress window. Given a trisyllabic window's sensitivity to the weight of the antepenult, however, as discussed in Chapter 4, the limits of the stress window in this context are crucial.

In exploring the stress pattern of Latin my primary purpose is to examine the effects of a stress window on a defaults-to-same-side system. Although NonFinality is also an important aspect of the pattern, I will not focus on it. I will simply assume that SNonFinality is ranked highly enough that it is not violated in the forms discussed. This being the case, only forms that satisfy SNonFinality will be considered in the tableaux that follow.

Given the high ranking of SNonFinality, there are three further steps in obtaining the stress pattern of Latin. The first is to establish the basic left-oriented defaults-to-same-side system. The second is to circumscribe this system with a stress window at the right edge of the prosodic word, and the third is to establish the stress window's reaction to a heavy antepenult. A left-oriented defaults-to-same-side system can be established for Latin with a similar ranking as that used for Murik above. The ranking is given in (84) with SNonFinality and MapGM (PrWd) in the appropriate dominant positions.

(84) Core Latin Ranking

SNonFinality, MapGM (PrWd) >> OBranchPG >> FG-Left

The effect for Latin of ranking OBranchPG over FG-Left is most easily seen in trisyllabic forms, where the stress window is not a factor. As (85) demonstrates using /ami:kus/, when there is a non-final heavy syllable present, ranking OBranchPG over FG-Left ensures that the gridmark column cannot occur over a light syllable, as in candidate (b), in order to have better leftward gridmark alignment. As (86) demonstrates using /símula:/, however, when there is no non-final heavy syllable present, FG-Left ensures that the gridmark column occurs as far to the left as possible.

(85) OBranchPG >> FG-Left

ami:kus	OBranchPG	FG-Left
<p style="text-align: center;">x x x x x x μ μ μ μ a. a mi kus ✓</p>		*
<p style="text-align: center;">x x x x x x μ μ μ μ b. a mi kus ✓</p>	*!	

In (85), both candidates are three syllable-forms with a heavy penult and light antepenult. By positioning its gridmark column over its initial syllable, candidate (b) is able to satisfy FG-Left, but because its initial syllable is also a light syllable, candidate (b) violates the higher ranked OBranchPG. Although positioning its gridmark column over its second syllable causes candidate (a) to violate FG-Left, the weight of the second syllable allows candi-

date (a) to satisfy OBranchPG. Since OBranchPG is the higher ranked constraint, candidate (a) correctly emerges as the winner.

(86) OBranchPG >> FG-Left

simula:	OBranchPG	FG-Left
<p>a. simu la</p>	*	
<p>b. simu la</p>	*	*!

In (86), both candidates are three-syllable forms with a light penult and light antepenult. Since both candidates position their gridmark columns over light syllables, the antepenult in the case of (a) and the penult in the case of (b), both violate OBranchPG, and the decision between them is passed on to FG-Left. Since the gridmark column of candidate (a) is closer to the left edge of the prosodic word than the gridmark column of candidate (b), (a) performs better with respect to FG-Left and correctly emerges as the winner.

Ranking OBranchPG over FG-Left, then, completes the first step in the analysis by establishing a left-oriented defaults-to-same-side system for Latin. To take the second step and appropriately circumscribe this system with a trisyllabic window, it is necessary that both FG-Left and OBranchPG be constrained. In other words, it is necessary that RWin rank above both constraints. As (87) demonstrates using /komítium/, ranking RWin over FG-Left ensures that the gridmark column cannot occur outside the trisyllabic window, as in candidate (b), in order to have better leftward gridmark alignment.

(87) RWin >> FG-Left

komitium	RWin	FG-Left
<pre> x x x x x x x μ μ μ μ μ a.ko mi ti um √ x x x x x x x μ μ μ μ μ b.ko mi ti um √ </pre>	<p style="text-align: center;">*!</p>	<p style="text-align: center;">*</p>

In (87), both candidates are four-syllable forms where each of the non-final syllables is light. By positioning its gridmark column over its initial syllable, candidate (b) is able to satisfy FG-Left, but because this positioning means misalignment between the final foot and the prosodic word-level gridmark, candidate (b) violates RWin. Although positioning its gridmark column over its second syllable causes candidate (a) to violate FG-Left, it also allows the final foot to be aligned with the prosodic word-level gridmark, so that candidate (a) satisfies RWin. Since RWin is the higher ranked constraint, candidate (a) correctly emerges as the winner.

As (88) demonstrates using /partikípium/, ranking RWin over OBranchPG ensures that the gridmark column cannot occur outside the trisyllabic window, as in candidate (b), in order to have primary stress on a heavy syllable.

(88) RWin >> OBranchPG

participium	RWin	OBranchPG
<pre> x x x x x x x x x μ μ μ μ μ μ μ a. par ti ki pi um √ </pre>		*
<pre> x x x x x x x x x μ μ μ μ μ μ μ b. par ti ki pi um √ </pre>	*!***	

In (88), both candidates are five-syllable forms where the initial and final syllables are heavy. Although the position of its gridmark column over the initial syllable allows candidate (b) to satisfy OBranchPG, this position also means misalignment between the final foot and the prosodic word-level gridmark, and candidate (b) violates RWin. By positioning its gridmark column over its second syllable, a light syllable, candidate (a) violates OBranchPG, but this position also allows alignment between the final foot and the prosodic word-level gridmark, and candidate (a) satisfies RWin. Since RWin is the higher ranked constraint, candidate (a) is the winner.

Having completed the first two steps in the analysis by establishing a left-oriented defaults-to-same-side system for Latin and by circumscribing this system with a stress window, the final step is to establish how the stress window will react to a heavy antepenult. In chapter 4, we discussed three options. First, the heavy antepenult might ignore the stress window and maintain a bipositional mapping, an option we have ruled out by ranking RWin over OBranchPG. In general, the stress window cannot be violated for the purposes of placing primary stress on a heavy syllable. Second, RWin might force shortening of the antepenult, or third, it could force monopositional mapping of the antepenult. To these we

can add a fourth option of forcing the gridmark column to a syllable further within the stress window. Where the phenomenon of trisyllabic shortening in English makes use of the second option, the stress pattern of Latin relies on the third and fourth. In particular for Latin, when there is a second (non-final) heavy syllable further within the trisyllabic window, as in /mone:bá:mus/, primary stress will occur on that syllable rather than on the heavy antepenult. When there is no second (non-final) heavy syllable further within the trisyllabic window, as in /doméstikus/, primary stress will remain on the heavy antepenult, but the syllable will be monopositionally mapped.

To obtain the case where primary stress occurs on a heavy penult rather than on the heavy antepenult, each of RWin, OBranchPG, and MapGM (Mora) must rank above FG-Left. As (89) demonstrates using /mone:bá:mus/, ranking RWin over FG-Left ensures that the gridmark column cannot occur over a bimensionally mapped heavy antepenult, as in candidate (d), in order to have better leftward gridmark alignment. Ranking OBranchPG over FG-Left ensures that the antepenult cannot be shortened, as in candidate (c), in order to maintain better leftward gridmark alignment, and ranking MapGM (Mora) over FG-Left ensures that the heavy antepenult cannot be monopositionally mapped, as in candidate (b), in order to maintain better leftward gridmark alignment.

(89) RWin, OBranchPG, MapGM (Mora) >> FG-Left

mone:ba:mus	RWin	OBranchPG	MapGM Mora	FG-Left
<p>a. mone ba mus</p>				***
<p>b. mone ba mus</p>			*!	*
<p>c. mone ba mus</p>		*!		*
<p>d. mone ba mus</p>	*!			*

In (89), positioning its gridmark column over its heavy, bimensionally mapped antepenult allows candidate (d) to satisfy OBranchPG, MapGM (Mora) and FG-Left, but because mapping the non-head mora of the antepenult causes misalignment between the final foot and the prosodic word-level gridmark, candidate (d) violates RWin where (a-c) do not and drops out. Positioning its gridmark column over a shortened antepenult allows candidate (c) to satisfy RWin, MapGM (Mora), and FG-Left, but since the gridmark column occurs over a light syllable, candidate (c) violates OBranchPG where (a) and (b) do not and drops out. Positioning its gridmark column over its heavy, monimensionally mapped antepenult allows

candidate (b) to satisfy RWin, OBranchPG, and FG-Left, but because the non-head mora of the antepenult is not mapped, candidate (b) violates MapGM (Mora) where (a) does not, and it drops out as well. Finally, positioning its gridmark column over its heavy, bipositionally mapped penult causes candidate (a) to violate FG-Left, it also allows (a) to do well enough on the higher ranked constraints to emerge as the winner.

To obtain the case where primary stress occurs on the heavy antepenult rather than shifting to a light penult, it is necessary to clarify the (89) ranking so that RWin and OBranchPG rank above MapGM (Mora). As (90) demonstrates using /doméstikus/, ranking RWin over MapGM (Mora) ensures that primary stress cannot occur over a heavy, bipositionally mapped antepenult, as in candidate (d), in order to preserve exhaustive moraic mapping. Ranking OBranchPG over MapGM (Mora) ensures both that the gridmark column cannot be moved to the light penult, as in candidate (b), and that the antepenult cannot be shortened, as in candidate (c), in order to preserve exhaustive moraic mapping.

(90) RWin, OBranchPG >> MapGM (Mora)

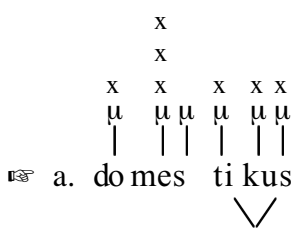
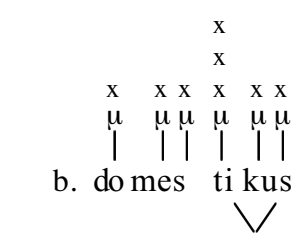
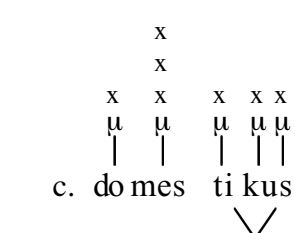
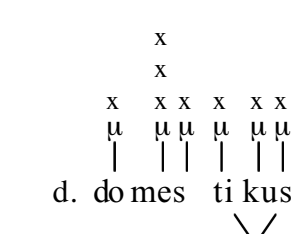
domestikus	RWin	OBranchPG	MapGM (Mora)
<p>a. </p>			*
<p>b. </p>		*!	
<p>c. </p>		*!	
<p>d. </p>	*!		

In (90), positioning its gridmark column over its heavy, bimensionally mapped antepenult allows candidate (d) to satisfy OBranchPG and MapGM (Mora), but because mapping the antepenult's non-head mora causes misalignment between the final foot and the prosodic word-level gridmark, candidate (d) violates RWin where (a-c) do not and drops out. Shortening its antepenult allows candidate (c) to satisfy MapGM (Mora) and RWin, but because this leaves the gridmark column over a light syllable, (c) violates OBranchPG where (a) does not and drops out. Positioning its gridmark column over the penult allows candidate (b) to satisfy MapGM (Mora) and to vacuously satisfy RWin, but because the penult is

light, candidate (b) violates OBranchPG where (a) does not and drops out. Finally, although positioning its gridmark column over its heavy, monopositionally mapped antepenult causes candidate (a) to violate MapGM (Mora), it also allows (a) to do well enough on the higher ranked constraints to emerge as the winner.

The final ranking, then, for primary stress in Latin is as given in (91) below.

(91) Final Latin Ranking

SNonFinality, MapGM (PrWd), RWin >> OBranchPG >> MapGM (Mora) >>
FG-Left

The ranking accomplishes three things. First, it creates a left-oriented, defaults-to-same-side system. Second, it circumscribes this basic system with a trisyllabic stress window. Third, it specifies how the stress window deals with heavy antepenults in various contexts. Overall, the ranking establishes a pattern matching the typical description: stress occurs on the penult in disyllabic forms and larger-than-disyllabic forms where the penult is heavy, otherwise stress occurs on the antepenult.

5.3.1.5 Summary

We have seen in the discussion above how the proposed account obtains both left-oriented and right-oriented defaults-to-same-side systems. We have also seen how NonFinality and Window constraints can affect such systems. In particular, we saw how SNonFinality limits the scope of these systems to pre-final syllables and how RWin limits their scope to a trisyllabic window at the right edge of the prosodic word. In the discussion that follows, we will see how the same mechanisms involved in producing defaults-to-same-side systems can be augmented to produce defaults-to-opposite-side systems.

5.3.2 Defaults to Opposite Side

Since they are also weight-sensitive unbounded stress systems, defaults-to-opposite-side systems share with defaults-to-same-side systems both the mechanism for producing weight-sensitivity and the mechanism for establishing a default edge. In other words, at the

core of defaults-to-opposite-side rankings are the core defaults-to-same-side rankings discussed above and repeated in (92) and (93) below:

(92) Leftward Default

MapGM (PrWd), OBranchPG >> FG-Left

(93) Rightward Default

MapGM (PrWd), OBranchPG >> FG-Right

For default-to-same-side systems, these rankings were sufficient to specify the default edge, to move stress away from the default edge when a heavy syllable was present, and to place stress on the heavy syllable nearest the default edge when multiple heavy syllables were present. This situation was possible because the directional orientation is the same in such systems whether or not heavy syllables are involved. In defaults-to-opposite-side systems, however, the directional orientation is different when heavy syllables are present than when they are not, meaning that the mechanism specifying directionality for stress on heavy syllables is likely distinct from the mechanism specifying the default edge.

In some sense, then, default-to-opposite-side systems require that stressed light syllables be aligned in one direction and stressed heavy syllables be aligned in the opposite direction. As straightforward as this approach might be (it is essentially the approach of Walker 1996), the restrictiveness of the grammar would be compromised by allowing alignment constraints to refer to complexities like “stressed and light and syllable” or “stressed and heavy and syllable”.

The same effect, however, can be obtained by referring to a structure that is present in stressed heavy syllables and absent in other syllables. This would allow an appropriate alignment constraint to influence the position of stressed heavy syllables while leaving all others unaffected. Two candidates for this unique structure, moras and the gridmark column of stressed syllables, can be dismissed immediately. First, while light syllables have one mora and heavy syllables have more than one, referring to moras in general does not allow alignment to distinguish between the two types. Second, although the presence of the grid-

mark column distinguishes stressed heavy syllables from unstressed syllables, it does not distinguish stressed heavy syllables from stressed light syllables.

Rather than a difference in weight or stress, then, I propose that the relevant factor separating stressed heavy syllables from other syllables is in how their moras are mapped to the metrical grid. If stressed heavy syllables are bimensionally mapped and all other syllables are monimensionally mapped, the position of stressed heavy syllables can be influenced by the mora-gridmark alignment constraints, MG-Left and MG-Right. MG-Left, for example, would prefer bimensionally mapped syllables, since they have a higher concentration of mora-level gridmarks, to occur nearer the left edge of a prosodic word, and MG-Right would prefer bimensionally mapped syllables, for the same reason, to occur near the right edge of a prosodic word.

The difficulty is ensuring that only stressed heavy syllables are bimensionally mapped, and it is in overcoming this difficulty that MapGridmark constraints specific to the domains of prosodic heads, as suggested in Chapter 2, play a role. Positing a constraint like that in (94) allows the grammar to ensure under appropriate rankings that all heavy syllables in the head foot of a prosodic word will be bimensionally mapped.

(94) MapGM (Mora, PrWd-Hd)

A mora-level gridmark occurs within the domain of every mora which occurs within the domain of the head of a prosodic word.

Since the syllable bearing the primary stress must be the within the domain of the head foot, all moras in that syllable must be mapped to the metrical grid. Heavy syllables bearing the primary stress, then, must be bimensionally mapped.

To ensure that only one heavy syllable per form is bimensionally mapped and that all others are monimensionally mapped, the specific MapGM (Mora, PrWd-Hd) must rank above mora-gridmark alignment, and mora-gridmark alignment must in turn rank over the more general MapGM (Mora). As (95) illustrates, if a heavy syllable bears primary stress, ranking MapGM (Mora, PrWd-Hd) over MG-Left ensures that this syllable cannot be monimensionally mapped, as candidate (d), in order to have fewer mora-level gridmarks, and,

thus, better leftward mora-gridmark alignment. Ranking MG-Left over MapGM (Mora) ensures that heavy syllables, other than those bearing primary stress, will not be bipositionally mapped, as in candidate (c), in an effort to have complete mapping of moras to the grid's base level. Notice also the directional effects of MG-Left. MG-Left ensures that the leftmost heavy syllable is the bipositionally mapped syllable, and not some syllable further to the right, as in candidate (b).

(95) MapGM (Mora, PrWd-Hd) >> MG-Left >> MapGM (Mora)

	MapGM (Mora, PrWd-Hd)	MG-Left	MapGM (Mora)
a. $\begin{array}{ccccccc} & & x & & & & \\ & & x & & & & \\ & & x & x & x & & x \\ \mu & \mu & \mu & \mu & \mu & \mu & \mu \\ \vee & \vee & \vee & & & & \\ \sigma & \sigma & \sigma & & & & \end{array}$		* * * * *	* *
b. $\begin{array}{ccccccc} & & & & & & x \\ & & & & & & x \\ x & & x & & x & x & \\ \mu & \mu & \mu & \mu & \mu & \mu & \mu \\ \vee & \vee & \vee & & & & \\ \sigma & \sigma & \sigma & & & & \end{array}$		* * * * * * * ! * * *	* *
c. $\begin{array}{ccccccc} & & x & & & & \\ & & x & & & & \\ x & x & x & x & x & x & x \\ \mu & \mu & \mu & \mu & \mu & \mu & \mu \\ \vee & \vee & \vee & & & & \\ \sigma & \sigma & \sigma & & & & \end{array}$		* * * * * * * ! * * * * * * *	
d. $\begin{array}{ccccccc} & & x & & & & \\ & & x & & & & \\ x & & x & & x & & \\ \mu & \mu & \mu & \mu & \mu & \mu & \mu \\ \vee & \vee & \vee & & & & \\ \sigma & \sigma & \sigma & & & & \end{array}$	* !	* * * * *	* * *

In (95), each of the candidates consists of three heavy syllables. The difference between the candidates is in the mapping of heavy syllables and the position of the stress column. Candidate (d), where the syllable bearing primary stress is monopositionally mapped, drops out first. Although the absence of bipositional mapping allows (d) to have the best possible

leftward mora-gridmark alignment given the length of the form, it also causes (d) to violate MapGM (Mora, PrWd-Hd) where (a-c) do not. Candidate (c), where every syllable is bipositionally mapped, drops out next. Bipositionally mapping allows candidate (c) to satisfy MapGM (Mora), but it also causes (c) to have more violations of MG-Left than either (a) or (b). The remaining two candidates each have a single bipositionally mapped syllable, the syllable bearing primary stress. Both satisfy MapGM (Mora, PrWd-Hd), and they perform equally well on MapGM (Mora). The difference between them is that the bipositionally mapped syllable is at the left edge in (a) and at the right edge in (b). Since the position of the bipositionally mapped syllable in candidate (a) allows it to perform better with respect to MG-Left than candidate (b), (a) emerges as the winner. Before moving on, it is important to notice that in candidate (d), where all syllables are monopositionally mapped, the position of primary stress does not influence the outcome. Primary stress could occur on any syllable with the same result. The same is true of candidate (c) where all syllables are bipositionally mapped. The directional preferences of MG-Left only influence the position of stressed syllables when the stressed syllable is the only syllable that is bipositionally mapped.

The interactions are similar replacing MG-Left with MG-Right in (96). Ranking MapGM (Mora, PrWd-Hd) over MG-Right ensures that a heavy syllable bearing primary stress cannot be monopositionally mapped, as candidate (d), in order to have fewer mora-level gridmarks, and, thus, better rightward mora-gridmark alignment. Ranking MG-Right over MapGM (Mora) ensures that heavy syllables, other than the one bearing primary stress, will not be bipositionally mapped, as candidate (c), in an effort to have complete moraic mapping. In addition, MG-Right ensures that the rightmost heavy syllable is the bipositionally mapped syllable, and not some syllable further to the left, as in candidate (b).

(96) MapGM (Mora, PrWd-Hd) >> MG-Right >> MapGM (Mora)

	MapGM (Mora, PrWd-Hd)	MG-Left	MapGM (Mora)
<p>a. $\begin{array}{ccccccc} & & & & & & x \\ & & & & & & x \\ & & x & x & x & x & \\ \mu & \mu & \mu & \mu & \mu & \mu & \\ \swarrow & \swarrow & \swarrow & \swarrow & \swarrow & \swarrow & \\ \sigma & \sigma & \sigma & & & & \end{array}$</p>		<p>* ** * ** *</p>	<p>**</p>
<p>b. $\begin{array}{ccccccc} & & & & & & x \\ & & & & & & x \\ & & x & x & x & & x \\ \mu & \mu & \mu & \mu & \mu & \mu & \\ \swarrow & \swarrow & \swarrow & \swarrow & \swarrow & \swarrow & \\ \sigma & \sigma & \sigma & & & & \end{array}$</p>		<p>* ** * ** * * ! ** *</p>	<p>**</p>
<p>c. $\begin{array}{ccccccc} & & & & & & x \\ & & & & & & x \\ & & x & x & x & x & x \\ \mu & \mu & \mu & \mu & \mu & \mu & \\ \swarrow & \swarrow & \swarrow & \swarrow & \swarrow & \swarrow & \\ \sigma & \sigma & \sigma & & & & \end{array}$</p>		<p>* ** ** * ** *! * ** ** *</p>	
<p>d. $\begin{array}{ccccccc} & & & & & & x \\ & & & & & & x \\ & & x & x & x & & \\ \mu & \mu & \mu & \mu & \mu & \mu & \\ \swarrow & \swarrow & \swarrow & \swarrow & \swarrow & \swarrow & \\ \sigma & \sigma & \sigma & & & & \end{array}$</p>	<p>*!</p>	<p>* ** * ** ** *</p>	<p>** *</p>

In (96), each of the candidates is again a three-syllable prosodic word, and each of the syllables is heavy. The difference between the candidates is in the mapping of heavy syllables and the position of primary stress. Candidate (d) drops out first. Although mapping its stressed syllable monopositionally allows (d) to have the best possible rightward moragriddmark alignment given the length of the form, it also causes (d) to violate MapGM (Mora, PrWd-Hd) where (a-c) do not. Candidate (c) drops out next. Mapping all of its syllables bipositionally allows candidate (c) to satisfy MapGM (Mora), but it also causes (c) to have more violations of MG-Right than either (a) or (b). Candidates (a) and (b) both have bipositional mapping for the syllable bearing primary stress. Both satisfy MapGM (Mora, PrWd-Hd), and they perform equally well on MapGM (Mora). The difference between

them is that the bimensionally mapped syllable is at the right edge in (a) and at the left edge in (b). Since the position of the bimensionally mapped syllable in candidate (a) allows it to perform better with respect to MG-Right than candidate (b), (a) emerges as the winner. Notice here as well that the directional preferences of MG-Right only influence the position of primary stress when the stressed syllable is the only syllable that is bimensionally mapped.

The rankings in (95) and (96), then, are sufficient to ensure that only heavy syllables bearing primary stress will be bimensionally mapped. The alignment component of these rankings also ensures that the bimensionally mapped syllable will be the one nearest the designated edge, the left edge in the case of (95) and the right edge in the case of (96). With this foundation, we turn to the larger interactions of default-to-opposite-side systems.

5.3.2.1 Constraint Interactions

In incorporating the (95) and (96) rankings into weight-sensitive unbounded stress systems, the central interactions occur in the context of high ranking OBranchPG and MapGM (Mora, PrWd-Hd) constraints and involve the competing preferences of a mora-gridmark alignment constraint and a foot-gridmark alignment constraint with opposite directional specifications.

Consider first in (97) the conflicting preferences of MG-Left and FG-Right when at least two heavy syllables occur in a form. Given that OBranchPG and MapGM (Mora, PrWd-Hd) are both satisfied— so that primary stress occurs on a heavy syllable and the heavy syllable is bimensionally mapped— MG-Left prefers that primary stress occur on the leftmost heavy syllable and FG-Right prefers that primary stress occur on the rightmost heavy syllable. Consider also in (98) the non-conflicting preferences of MG-Left and FG-Right when there are no heavy syllables in a form. In this case OBranchPG could not be satisfied, and MapGM (Mora, PrWd-Hd) would always be satisfied. MG-Left and FG-Right both agree on stressing the rightmost syllable.

(97) MG-Left and FG-Right: Heavy Syllables Present

	MG-Left	FG-Right
<p>a.</p> <pre> x x x x x x μ μ μ μ μ / / σ σ σ </pre>	* ** ***	****
<p>b.</p> <pre> x x x x x x μ μ μ μ μ / / σ σ σ </pre>	** *** *****	*

In (97), both candidates contain three syllables, and the first and third are heavy. Both candidates also place primary stress on a heavy syllable, and the stressed syllables are bipositionally mapped. Because candidate (a) stresses the leftmost heavy syllable and candidate (b) stresses the rightmost heavy syllable, the concentration of mora-level gridmarks accompanying stressed heavy syllables occurs at the left edge in (a) and at the right edge in (b). This allows candidate (a) to perform better with respect to MG-Left. Because the supporting foot-level gridmark is also nearer the left edge in (a), however, and nearer the right edge in (b), candidate (b) performs better with respect to FG-Right. MG-Left prefers candidate (a), and FG-Right prefers candidate (b).

(98) MG-Left and FG-Right: No Heavy Syllables Present

	MG-Left	FG-Right
x x x x x a. μ μ μ σ σ σ	* **	* *
x x x x x b. μ μ μ σ σ σ	* **	

In (98), both candidates contain three light syllables. Since primary stress occurs over a light syllable in both, the concentration of mora-level gridmarks accompanying stressed heavy syllables is not a consideration, and both candidates perform equally with respect to MG-Left. Because the supporting foot-level gridmark is nearer the left edge in (a), however, and nearer the right edge in (b), candidate (b) performs better with respect to FG-Right. MG-Left and FG-Right, then, can both agree on candidate (b).

Consider next in (99) the conflicting preferences of MG-Right and FG-Left when heavy syllables are present in a form. Assuming again that OBranchPG and MapGM (Mora, PrWd-Hd) are satisfied, MG-Right prefers that primary stress occur over the rightmost heavy syllable, and FG-Left prefers that primary stress occur over the leftmost heavy syllable. Consider also in (100) the non-conflicting preferences of MG-Right and FG-Left when there are no heavy syllables present. Both agree on primary stress over the leftmost syllable.

(99) MG-Right and FG-Left: Heavy Syllables Present

	MG-Right	FG-Left
<p>a.</p> <pre> x x x x x x μ μ μ μ μ \ / \ σ σ σ </pre>	<p>* ** *****</p>	<p>****</p>
<p>b.</p> <pre> x x x x x x μ μ μ μ μ \ / \ σ σ σ </pre>	<p>* ** *** ****</p>	

In (99), each candidate consists of three syllables, the first and third being heavy. Each candidate also stresses a heavy syllable, and the stressed syllable is bipositionally mapped. Because the concentration of mora-level gridmarks accompanying stressed heavy syllables occurs nearer the right edge in candidate (a) and nearer the left edge in candidate (b), candidate (a) performs better with respect to MG-Right. Because this also means, however, that the supporting foot-level gridmark is nearer the right edge in candidate (a) and nearer the left edge in candidate (b), candidate (b) performs better with respect to FG-Left. MG-Right, then, prefers candidate (a), and FG-Left prefers candidate (b).

(100) MG-Right and FG-Left: No Heavy Syllables Present

	MG-Right	FG-Left
<p>a.</p> <pre> x x x x x μ μ μ σ σ σ </pre>	* **	* *
<p>b.</p> <pre> x x x x x μ μ μ σ σ σ </pre>	* **	

In (100), each candidate consists of three light syllables. Because the concentration of mora-level gridmarks accompanying stressed heavy syllables is not a factor, both candidates perform equally well on MG-Right. Because the supporting foot-level gridmark occurs nearer the right edge in candidate (a), however, and nearer the left edge in candidate (b), candidate (b) performs better with respect to FG-Left. Both constraints, then, can agree on candidate (b).

To produce a defaults-to-opposite-side system with a leftward default, the first step is to establish weight-sensitivity and leftward orientation in forms with only light syllables. This is accomplished with the ranking in (101). The second step is to establish the bipositional mapping and rightward orientation of heavy syllables bearing primary stress. This is accomplished with the ranking in (102).

(101) Leftward Default

MapGM (PrWd), OBranchPG >> FG-Left

(102) Rightward Orientation of Stressed Heavy Syllables

MapGM (Mora, PrWd-Hd) >> MG-Right >> MapGM (Mora)

In combining the two rankings, it is simply necessary that MG-Right rank above FG-Left.

In producing a defaults-to-opposite-side system with a rightward default, the ranking in (103) establishes weight-sensitivity and rightward orientation in forms with only light syllables. The ranking in (104) is responsible for establishing the bipositional mapping and leftward orientation of heavy syllables bearing primary stress.

(103) Rightward Default

MapGM (PrWd), OBranchPG >> FG-Right

(104) Leftward Orientation of Stressed Heavy Syllables

MapGM (Mora, PrWd-Hd) >> MG-Left >> MapGM (Mora)

In combining the two rankings, it is simply necessary that MG-Left rank above FG-Right.

In considering examples of defaults-to-opposite-side systems below, I will focus on the interactions between OBranchPG, mora-gridmark alignment and foot-gridmark alignment. Although the remaining constraints play important roles in the analysis, as we have seen above; the OBranchPG constraint is the most prominent in producing weight-sensitivity, and the alignment constraints are most prominent in determining directionality.

5.3.2.2 Rightward Default: Kwakwala

Kwakwala (Boas 1947 and Zec 1994) is a defaults-to-opposite-side system where the right edge is the default edge:

(105) Kwakwala Forms (from Zec 1994)

LĹ	c'əxəlá	<i>to be sick</i>
LĹ	məc'ətá	<i>to heal (pl.)</i>
́HLL	x ^w á:k ^w əna	<i>canoe</i>
́HLH	dʒ́əmbətəls	<i>to bury in hole in ground</i>
ĹHH	məxənxənd	<i>to strike edge</i>

As illustrated in (105), stress in Kwakwala occurs on the leftmost heavy syllable or, in the absence of heavy syllables, on the rightmost syllable. Heavy syllables in Kwakwala are (C)V: or (C)VS, where S is a non-glottalized sonorant.

Assuming the rankings from (103) and (104) above, the crucial interactions in Kwakwala are those between OBranchPG, the constraint responsible for weight-sensitivity; MG-Left, the constraint responsible for locating bipositionally mapped syllables; and FG-Right, the constraint responsible for establishing the default edge. The latter two constraints, MG-Left and FG-Right, are most directly responsible for the difference in directional orientation in Kwakwala between forms where heavy syllables are present and forms where heavy syllables are absent. Because MG-Left influences mora-level gridmarks and because heavy stressed syllables in this context contain one more such gridmark than other syllables, the effects of MG-Left target heavy stressed syllables in particular. However, because FG-Right influences foot-level gridmarks, and all stressed syllables have foot-level gridmarks, FG-Right targets stressed syllables in general. Given the appropriate ranking, then, the more specific MG-Left will control directionality when heavy syllables are present, and the more general FG-Right will control directionality when heavy syllables are absent.

As (106) illustrates using /məx́ənxənd/, OBranchPG must rank above MG-Left, and MG-Left must in turn rank above FG-Right, in order to obtain the correct results for forms with heavy syllables. Ranking OBranchPG over MG-Left ensures that the gridmark column does not occur over a light syllable, as in candidate (c), in order to avoid a bipositionally mapped heavy syllable and the additional mora-gridmark alignment violations that come with it. Ranking MG-Left over FG-Right ensures that the gridmark column does not occur on a heavy syllable other than the leftmost, as in candidate (b), in order for the supporting foot-level gridmark to be nearer the right edge.

(106) OBranchPG >> MG-Left >> FG-Right

məxənχənd	OBranchPG	MG-Left	FG-Right
<pre> x x x x x x μ μ μ μ a. mə χən χənd </pre>		* ** ***	***
<pre> x x x x x x μ μ μ μ b. mə χən χənd </pre>		* *** ***!*	*
<pre> x x x x x μ μ μ μ c. mə χən χənd </pre>	*!	* ***	****

In (106), the first syllable of each candidate is light, and the second and third syllables are heavy. Candidate (c) drops out first. Positioning its gridmark column over a light syllable allows candidate (c) to map all syllables monopositionally and, thus, to have an advantage with respect to mora-gridmark alignment, but it also means that the prosodic word-level gridmark does not have a moraic descent category within the syllable, causing (c) to violate OBranchPG where (a) and (b) do not. Candidate (b) drops out next. Positioning its gridmark column over the heavy final syllable allows candidate (b) to satisfy OBranchPG and to have an advantage with respect to FG-Right, but it also causes (b) to have more violations of MG-Left than (a). Although the position of its gridmark column over the leftmost heavy syllable puts candidate (a) at a disadvantage with respect to FG-Right, it also allows (a) to do well enough on the higher ranked constraints to emerge as the winner.

The ranking in (106), then, obtains the correct result for forms with heavy syllables, with MG-Left being the key factor in locating stress on the leftmost. As (107) demonstrates

using /c'əxəlá/, this same ranking also makes the correct predictions for forms without heavy syllables, but in this case FG-Right is the key factor in locating the gridmark column.

(107) OBranchPG >> MG-Left >> FG-Right

c'əxəla	OBranchPG	MG-Left	FG-Right
<pre> x x x x x μ μ μ a. c'ə xə la </pre>	*	* **	
<pre> x x x x x μ μ μ b. c'ə xə la </pre>	*	* **	*!*

In (107), both candidates consist of three light syllables. The only difference between them is in the location of their gridmark columns, over the leftmost syllable in candidate (b) and over the rightmost syllable in candidate (a). Since neither candidate has a heavy syllable, neither can satisfy OBranchPG, and the constraint does not distinguish between them. Neither does MG-Left distinguish between the two, as both have an identical number of violations. The decision, then, falls to FG-Right, and since the supporting foot-level gridmark in the column of candidate (a) is closer to the right edge than that in the column of candidate (b), the (a) candidate correctly emerges as the winner.

In the context, then, of the complete rankings from (103) and (104) above, the ranking in (106, 107) obtains the defaults-to-opposite-side pattern exhibited by Kwakwala. Weight-sensitivity is produced by the demands of OBranchPG, and the two gridmark alignment constraints, MG-Left and FG-Right, produce the effect of conflicting directionality. MG-Left establishes the leftward orientation of stressed heavy syllables, and FG-Right establishes the right edge as the default edge.

5.3.2.3 Leftward Default: Selkup

Selkup (Kuznecova, Xelimskij, and Gruskina 1980 and Halle and Clements 1983) is a defaults-to-opposite-side system where the left edge is the default edge:

(108) Selkup Forms (from Halle and Clements 1983)

́LL	ámirna	<i>eats</i>
́LLL	qóɫcimpatɪ	<i>found</i>
LĹ	kananmí:	<i>our dog</i>
H́L	u:có:mit	<i>we work</i>
LHĹ	qumo:qlilí:	<i>your two friends</i>

As illustrated in (108), stress in Selkup occurs on the rightmost heavy syllable, or in the absence of a heavy syllable, on the leftmost syllable. Heavy syllables in Selkup are (C)V:

The analysis of Selkup is similar to that of Kwakwala above, the difference being a reversal in directional specifications. OBranchPG is still responsible for the system's weight-sensitivity, but this time MG-Right is responsible for locating bipositionally mapped syllables, and FG-Left is responsible for establishing the default edge. Assuming the rankings from (101) and (102) above, the correct results for forms with heavy syllables are obtained in particular by ranking OBranchPG over MG-Right and by ranking MG-Right over FG-Left. As (109) illustrates using /u:có:mit/, ranking OBranchPG over MG-Right ensures that the gridmark does not occur over a light syllable, as in candidate (c), in order to avoid a bipositionally mapped heavy syllable and the associated additional violations of mora-gridmark alignment. Ranking MG-Right over FG-Left ensures that the gridmark column does not occur on a heavy syllable other than the rightmost, as in candidate (b), in order for the supporting foot-level gridmark to be nearer the left edge.

(109) OBranchPG >> MG-Right >> FG-Left

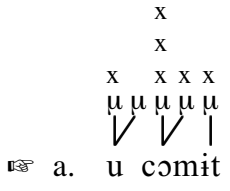
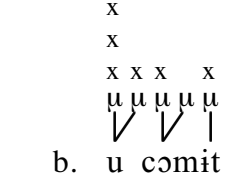
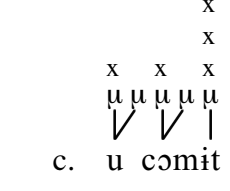
u:cɔ:mit	OBranchPG	MG-Right	FG-Left
<p>a. </p>		<p>* ** ***** (7)</p>	<p>**</p>
<p>b. </p>		<p>** *** ***!* (9)</p>	<p>*</p>
<p>c. </p>	<p>*!</p>	<p>** ***** (6)</p>	<p>*****</p>

In (109), the first and second syllables of each candidate are heavy, and the third syllable is light. Although locating its gridmark column over a light syllable allows candidate (c) to maintain monopositional mapping and an advantage with respect to mora-gridmark alignment, candidate (c) drops out because the lack of a moraic descent category causes it to violate OBranchPG where (a) and (b) do not. Locating its gridmark column over the heavy initial syllable allows candidate (b) to satisfy OBranchPG and FG-Left, but (b) drops out as well because a bipositionally mapped syllable in this position causes it to have more violations of MG-Right than candidate (a). Finally, although locating its gridmark column over the rightmost heavy syllable causes (a) to have more violations of FG-Left, it also allows (a) to do well enough on the higher ranked constraints to emerge as the winner.

In forms with heavy syllables, then, the (109) ranking correctly locates stress on the rightmost. As (110) illustrates using /ámirna/, this same ranking correctly locates stress on the leftmost syllable in forms with only light syllables.

(110) OBranchPG >> MG-Right >> FG-Left

amirna	OBranchPG	MG-Right	FG-Left
<pre> x x x x x μ μ μ a. amir na x x x x x μ μ μ b. amir na </pre>	*	* **	
	*	* **	*!*

In (110), both candidates consist of three light syllables, the difference between them being that the gridmark column occurs over the initial syllable in candidate (a) and over the final syllable in candidate (b). Since neither candidate has heavy syllables, neither is able to have a moraic descent category within the syllable for the prosodic word-level gridmark, and OBranchPG cannot distinguish between them. Also due to the absence of heavy syllables, the mapping for the two candidates to the moraic level of the grid is identical. Each has the best possible mora-gridmark alignment given the length of the form, and MG-Right fails to distinguish between them as well. The decision falls to FG-left, and since the position of its supporting foot-level gridmark allows candidate (a) to have fewer violations than candidate (b), (a) correctly emerges as the winner.

We have seen to this point that a difference in bipositional *vs.* monopositional mapping allows stressed heavy syllables to be influenced by alignment in ways that are not available to other syllables. This allows the proposal to obtain defaults-to-opposite-side systems by aligning stressed heavy syllables in one direction and, in the absence of heavy syllables, aligning stress in the opposite direction. Below, we turn to the stress pattern of Classical Arabic to examine the effects of SNonFinality on such systems.

5.3.2.4 Classical Arabic

Classical Arabic (McCarthy 1979), like Selkup above, is a defaults-to-opposite-side system with a leftward default. In Classical Arabic, however, the system is constrained by NonFinality within the prosodic word:

(111) Classical Arabic Forms (from McCarthy 1979)

´LLL	kátaba	<i>he wrote</i>
´LLH	bálahatun	<i>date (nom. sg.)</i>
L´LL	yušáariku	<i>he participates</i>
H´LLH	mámlakatun	<i>kingdom (nom. sg.)</i>
LH´H´H	manaadíluu	<i>kerchiefs (nom.)</i>

As illustrated in (111), stress in Classical Arabic occurs on the rightmost non-final heavy syllable, and in the absence of a non-final heavy syllable, on the leftmost syllable. Heavy syllables are CVV and CVC.⁴

Given the core ranking for a defaults-to-opposite-side system with leftward default, demonstrated above, the only additional concern in obtaining the Classical Arabic pattern is preventing stress from occurring on the final syllable. Since the default is leftward, there is no conflict with this requirement in forms with only light syllables. The rightward orientation of forms with heavy syllables, however, and even basic weight-sensitivity, must be circumscribed to prevent stress from occurring on the rightmost heavy syllable just in case this syllable is also the final syllable. This can be accomplished by ranking SNonFinality highly enough to restrict the workings of the core defaults-to-opposite-side system to the domain of pre-final syllables.

In forms with multiple heavy syllables, the key concern is restricting rightward orientation. As (112) illustrates using /manaadíluu/, ranking SNonFinality over MG-Right implements the needed restriction by ensuring that stress does not occur on the final syllable.

⁴ Classical Arabic also has superheavy CVVC and CVCC syllables. These occur in a very limited distribution influenced by syntactic considerations. Although the superheavy syllables do attract final stress, I will set this factor aside and focus on the basic pattern.

ble, as in candidate (c), in order to locate the bipositionally mapped syllable nearer to the right edge. This ranking does not mean, however, that the demands of MG-Right will be completely ignored. MG-Right still ensures that the gridmark column does not occur further to the left than necessary, as in candidate (b).

(112) SNonFinality >> MG-Right

manaadiiluu	SNonFinality	MG-Right
<p>a.ma na di lu</p>		(17)
<p>b.ma na di lu</p>		(19)!
<p>c.ma na di lu</p>	*!	(15)

In (112), the first syllable of each candidate is light, and the second, third, and fourth are heavy. Locating its gridmark column over the final syllable allows candidate (c) to position the extra mora-level gridmark that accompanies bipositional mapping nearer the right edge, giving (c) an advantage with respect to MG-Right. This location, however, does not allow the supporting foot-level gridmark to have a syllabic descent category within the prosodic word, and candidate (c) drops out because it violates SNonFinality where (a) and (b) do not. Neither candidate (a), where the gridmark column occurs over the penult, nor candidate (b), where the gridmark column occurs over the antepenult, violate SNonFinality, and the decision between them is passed on to MG-Right. Since the location of its gridmark column

allows candidate (a) to position the extra mora-level gridmark accompanying bipositional mapping nearer the right edge than does the location of the gridmark column in candidate (b), (a) correctly emerges as the winner.

In forms where the only heavy syllable is the final syllable, the key concern is restricting weight-sensitivity. As (113) illustrates using /bálahatun/, ranking SNonFinality over OBranchPG implements this restriction by ensuring that stress does not occur on the final syllable, as in candidate (b), in order for the prosodic word-level gridmark to have a moraic descent category within the syllable.

(113) SNonFinality >> OBranchPG

	balahatun	SNonFinality	OBranchPG
a.	<pre> x x x x x x μ μ μ μ μ ba la ha tu n </pre>		*
b.	<pre> x x x x x x x μ μ μ μ μ ba la ha tu n </pre>	*!	

In (113), the first three syllables of both candidates are light, and the fourth is heavy. The difference between them is that the gridmark column occurs over the final heavy syllable in candidate (b) and over the light initial syllable in candidate (a). Although locating the column over its final syllable allows candidate (b) to satisfy OBranchPG, it also causes (b) to violate SNonFinality where (a) does not. Locating its column over the light initial syllable causes (a) to violate OBranchPG, but it also allows (a) to do well enough on the higher ranked constraint to emerge as the winner.

The following ranking, then, in the context of the core ranking for leftward default systems obtains the correct predictions for Classical Arabic.

(114) Classical Arabic Ranking

SNonFinality >> OBranchPG >> MG-Right >> FG-Left

By ranking SNonFinality over OBranchPG and MG-Right, the basic defaults-to-opposite-side system is limited to pre-final syllables. In particular, ranking SNonFinality over MG-Right prevents stress from occurring on the rightmost heavy syllable just in case it is also the final syllable, and ranking SNonFinality over OBranchPG prevents stress from occurring on a heavy syllable just in case the only heavy syllable is also the final syllable.

5.4 Summary

In the discussion of weight-sensitivity in this chapter, we examined the relationship between heavy syllables and stress both from the direction of weight to stress and the direction of stress to weight. The Weight-to-Head constraint, repeated in (115), and the Hvy-Right constraint, repeated in (116), were instrumental in establishing the former relationship, and the moraic NonFinality constraints, repeated in (117), were instrumental in establishing the latter.

(115) Weight-to-Head

Every heavy syllable must be designated as the head of some foot.

(116) Hvy-Rt or Align (Mora-DC(Ft), L, Ft-GM, R)

The left edge of every moraic descent category within the domain of the foot is aligned with the right edge of its foot-level gridmark.

(117) Moraic NonFinality Constraints

a. Moraic NonFinality in the Prosodic Word

MNonFinality or NonFin (Ft-GM, Mora, PrWd): Every foot-level gridmark has a moraic descent category within the domain of the prosodic word.

b. Moraic NonFinality in the Foot

ILength or NonFin (Ft-GM, Mora, Ft): Every foot-level gridmark has a moraic descent category within the domain of the foot.

c. Moraic NonFinality in the Syllable

OBranchFG or NonFin (Ft-GM, Mora, Syll): Every foot-level gridmark has a moraic descent category within the domain of the syllable.

OBranchPG or NonFin (PrWd-GM, Mora, Syll): Every PrWd-level gridmark has a moraic descent category within the domain of the syllable.

We began by examining the relationship from weight to stress. The interactions involving Weight-to-Head, MapGM (Ft), and Hvy-Rt were instrumental in producing the desired perturbations in the Hixkaryana and Cahuilla stress patterns. Next, we examined the relationship from stress to weight. Moraic NonFinality in the prosodic word allowed stress to be sensitive to the weight of prosodic word-final syllables and was instrumental in obtaining the Wergaia stress pattern. Moraic NonFinality in the foot allowed stress to be sensitive to the weight of foot-final syllables and was instrumental in obtaining iambic lengthening in Choctaw. Finally, moraic NonFinality in the syllable allowed stress to be sensitive to syllable weight generally. It was instrumental in obtaining both the iambic lengthening pattern of Hixkaryana and the trochaic lengthening pattern of Chimalapa Zoque, and it was instrumental in producing both defaults-to-same-side and defaults-to-opposite-side unbounded stress patterns.

CONCLUSION

The primary motivation for this dissertation was to eliminate discrepancies between the range of binary stress patterns predicted by standard accounts and the range of patterns that are actually attested. We saw in Chapter 1 that the attested patterns were significantly fewer than the predicted patterns, and I outlined a proposal that would close the gap. The proposal departed from standard accounts both in the structural assumptions it made and in the constraints it utilized. The proposed account insisted on Strict Succession and rejected Proper Bracketing. In allowing prosodic categories to intersect, the proposal took advantage of a reformulated relationship between feet and stress. This reformulated relationship was itself a departure from standard accounts. Not only was the relationship between feet and stress violable, but gridmark entries could be shared between two intersected feet. The proposed account shifted emphasis away from the symmetrical alignment constraints and towards asymmetrical constraints like NonFinality and Initial Gridmark. Part of the restriction on alignment was in establishing a default connection between foot-type and footing directionality. This was accomplished by rejecting alignment of feet within a prosodic word in favor of alignment of foot-heads within a prosodic word. The result was a system that was more restrictive than that of standard accounts and one that predicted the range of attested binary stress patterns much more accurately.

In Chapter 2, I laid out the proposal's structural assumptions in more detail. We examined the first three components of the proposed account— the prosodic hierarchy, prosodic prominence, and the metrical grid— the conditions and constraints that governed their internal organization, and the conditions and constraints that either facilitated or restricted interaction between them. In Chapter 3, we examined alignment's role in the proposed account. Foot-head alignment not only established a default connection between foot-type and footing directionality, as we saw in Chapter 1, but it also had crucial structure minimizing properties. Because foot-head alignment preferred a minimal number of foot-heads, and

thus a minimal number of feet, it favored non-intersected binary footing, avoiding both monosyllabic feet and intersections where possible. Gridmark alignment constraints were also introduced in Chapter 3, allowing the proposal to expand beyond binary patterns. The interactions between foot-head alignment, foot-gridmark alignment, and MapGM (Ft) determined whether a particular system would emerge as binary, ternary, or unbounded.

Chapter 4 introduced a fourth system to the theory, the slope category system. The slope category system provided special designations to prosodic categories that occurred between a gridmark and the edges of a prosodic domain. These specially designated categories were then referred to by NonFinality constraints, Initial Gridmark constraints, and Window constraints. NonFinality constraints established minimal distances between gridmarks and right edge of a prosodic domain, Initial Gridmark constraints demanded the greatest possible distance between some gridmark and the right edge of a form, and Window constraints established maximal distances between gridmarks and either edge of some prosodic domain. In examining NonFinality constraints in more detail, we saw that they were crucial in correctly predicting two of the asymmetrically attested binary patterns from Chapter 1, the double offbeat pattern and the internal ternary pattern. We also saw that NonFinality accounted for two additional asymmetrically attested binary patterns, the even offbeat and even downbeat patterns. Initial Gridmark constraints completed the account of the original typology by correctly predicting the remaining two asymmetrically attested patterns, the double downbeat and edge ternary patterns. Finally, Window constraints, alignment constraints referring to slope categories, enabled the proposal to establish trisyllabic windows for primary stress at both the right and left edges of prosodic words.

In the discussion of weight-sensitivity in Chapter 5, we examined the relationship between stress and syllable weight both from the direction of weight to stress (the preference of heavy syllables to be stressed) and from the direction of stress to weight (the preference of stress to occur on heavy syllables). The Weight-to-Head constraint was the primary mechanism for establishing the former direction, and moraic NonFinality constraints were

the mechanisms for establishing the latter direction. The crucial interactions involving Weight-to-Head occurred with foot-head alignment constraints. By insisting that heavy syllables be foot-heads, Weight-to-Head was able to fix the positions of foot-heads contrary to the demands of foot-head alignment. We saw that this led to perturbations in basic binary patterns. The crucial interactions involving moraic NonFinality constraints occurred with Faithfulness constraints and gridmark alignment constraints. Moraic NonFinality in the foot and syllable promoted both iambic and trochaic lengthening. Moraic NonFinality in the syllable was also crucial in obtaining weight-sensitive unbounded stress systems of both the defaults-to-same-side and defaults-to-opposite-side varieties.

REFERENCES

- Abbot, Stan, 1985. A tentative multilevel multiunit phonological analysis of the Murik language. *Papers in New Guinea Linguistics* 22, 339-373.
- Alderete, John, 1995. Faithfulness to prosodic heads. Ms. University of Massachusetts, Amherst. ROA-94, Rutgers Optimality Archive, <http://rucss.rutgers.edu/roa.html>.
- Arnason, Kristjan, 1980. *Quantity in Historical Phonology: Icelandic and Related Cases*. Cambridge Studies in Linguistics 30. Cambridge: Cambridge University Press.
- Arnason, Kristjan, 1985. Icelandic word stress and metrical phonology. *Studia Linguistica* 39, 93-129.
- Bakovic, Eric, 1998. Unbounded stress and factorial typology. Ms. Rutgers University. ROA-244, Rutgers Optimality Archive, <http://rucss.rutgers.edu/roa.html>.
- Beckman, Jill, 1998. Positional Faithfulness. Ph. D. dissertation. University of Massachusetts, Amherst.
- Behrens, Dietlinde, 1975. Yakan phonemics and morphophonemics. *Pacific Linguistics, Series A*, No. 44, 13-28.
- Blevins, Juliette, 1990. Alternatives to exhaustivity and conflation in metrical theory. Ms., University of Texas, Austin.
- Boas, Franz, 1947. Kwakiutl grammar with a glossary of the suffixes. *Transactions of the American Philosophical Society, New Series* 37, Part 3, 201-377.
- Bosson, James E., 1964. *Modern Mongolian*. Uralic and Altaic Series 38. Indiana University, Bloomington.
- Boxwell, Helen, and Maurice Boxwell, 1966. Weri phonemes. In: Stephen A. Wurm, ed., *Papers in New Guinea Linguistics* 5, 77-93. Australian National University, Canberra.
- Breen, John Gavin, 1973. *Bidyara and Gungabula: grammar and vocabulary*. Linguistic Communications 8. Monash University, Melbourne.
- Chomsky, Noam, and Morris Halle, 1968. *The Sound Pattern of English*. New York: Harper and Row.
- Cohn, Abigail, 1989. Stress in Indonesian and bracketing paradoxes. *Natural Language and Linguistic Theory* 7, 167-216.
- Cohn, Abigail, 1993. The initial dactyl effect in Indonesian. *Linguistic Inquiry* 24, 372-381.
- Comrie, Bernard, 1976. Irregular stress in Polish and Macedonian. *International Review of Slavic Linguistics* 1, 227-240.
- Cooper, Grosvenor, and Leonard Meyer, 1960. *The Rhythmic Structure of Music*. Chicago: University of Chicago Press.
- Crowhurst, Megan, 1991. Demorification in Tubatulabal: evidence from initial reduplication and stress. *Northeastern Linguistic Society* 21, 49-63.

- Crowhurst, Megan, 1996. An optimal alternative to conflation. *Phonology* 13, 409-424.
- Crowhurst, Megan and Mark Hewitt, 1995. Directional footing, degeneracy, and alignment. Ms. University of North Carolina and University of British Columbia. ROA-65, Rutgers Optimality Archive, <http://ruccs.rutgers.edu/roa.html>.
- Crowley, Terry, 1981. The Mpakwithi dialect of Anguthimri. In: R. M. W. Dixon and Barry J. Blake, eds., *Handbook of Australian Languages*, vol. 2, 146-194. Amsterdam: John Benjamins.
- Derbyshire, Desmond C., 1985. Hixkaryana and Linguistic Typology. *SIL Publications in Linguistics* 76. Summer Institute of Linguistics, Dallas.
- Dixon, R. M. W., 1981. Wargamay. In: R. M. W. Dixon and Barry J. Blake, eds., *Handbook of Australian Languages*, vol. 2, 1-144. Amsterdam: John Benjamins.
- Echeverria, Max S., and Heles Contreras, 1965. Araucanian phonemics. *International Journal of American Linguistics* 31, 132-135.
- Everett, Daniel L., 1996. Prosodic levels and constraints in Banawa and Suruwaha. Ms. University of Pittsburgh. ROA-121, Rutgers Optimality Archive, <http://ruccs.rutgers.edu/roa.html>.
- Furby, Christine, 1974. Garawa phonology. *Pacific Linguistics, Series A*. Australian National University, Canberra.
- Green, Thomas, 1993. Configurational constraints in a generalized theory of phonological representation. Ph. D. dissertation. Massachusetts Institute of Technology, Cambridge.
- Green, Thomas, 1995. The stress window in Pirahã: a reanalysis of rhythm in Optimality Theory. Ms. Massachusetts Institute of Technology, Cambridge. ROA-45, Rutgers Optimality Archive, <http://ruccs.rutgers.edu/roa.html>.
- Green, Thomas, and Kenstowicz, Michael 1995. The Lapse Constraint. Ms. Massachusetts Institute of Technology, Cambridge. ROA-101, Rutgers Optimality Archive, <http://ruccs.rutgers.edu/roa.html>.
- Haas, Mary, 1977. Tonal accent in Creek. In: Larry Hyman, ed., *Studies in stress and accent*. Southern California Occasional Papers in Linguistics 4, 195-208. Department of Linguistics, University of Southern California, Los Angeles.
- Halle, Morris, 1990. Respecting metrical structure. *Natural Language and Linguistic Theory* 8, 149-176.
- Halle, Morris, and George N. Clements, 1983. *Problem book in phonology*. Cambridge, MA: MIT Press.
- Halle, Morris, and Jean-Roger Vergnaud, 1987. *An essay on stress*. Cambridge, MA: MIT Press.
- Hammond, Michael, 1984. Constraining metrical theory: a modular theory of rhythm and destressing. Ph. D. dissertation, University of California, Los Angeles.

- Hammond, Michael, 1986. The obligatory branching parameter in metrical theory. *Natural Language and Linguistic Theory* 4, 185-228.
- Hansen, Kenneth C., and L. E. Hansen, 1969. Pintupi phonology. *Oceanic Linguistics* 8, 153-170.
- Hayes, Bruce, 1981. A metrical theory of stress rules. Ph. D. dissertation. Massachusetts Institute of Technology, Cambridge.
- Hayes, Bruce, 1987. A revised parametric metrical theory. *Northeastern Linguistic Society* 17, 274-289.
- Hayes, Bruce, 1995. *Metrical Stress Theory: Principles and Case Studies*. Chicago: University of Chicago Press.
- Hercus, Louise A., 1986. *Victorian Languages: A Late Survey*. Pacific Linguistics B77. Australian National University, Canberra.
- Hewitt, Mark S., 1994. Deconstructing foot binarity in Koniag Alutiiq. Ms. University of British Columbia, Vancouver. ROA-12, Rutgers Optimality Archive, <http://ruccs.rutgers.edu/roa.html>.
- Hoff, Berend, 1968. The Carib Language. *Verhandelingen van het Koninklijk Instituut voor Taal-, Land-, en Volkenkunde* 55. The Hague: M. Nijhoff.
- Hualde, José I., 1998. A gap filled: postpostinitial accent in Azkoitia Basque. *Linguistics* 36, 99-117.
- Hung, Henrietta, 1993. Iambicity, rhythm, and non-parsing. Ms. University of Ottawa. ROA-9, Rutgers Optimality Archive, <http://ruccs.rutgers.edu/roa.html>.
- Hung, Henrietta, 1994. The Rhythmic and Prosodic Organization of Edge Constituents. Ph. D. dissertation. Brandeis University, Waltham, Massachusetts.
- Inkelas, Sharon, 1989. *Prosodic Constituency in the Lexicon*. Ph. D. dissertation. Stanford University. Published 1990. New York: Garland Press.
- Itkonen, Erkki, 1955. Ueber die Betonungsverhältnisse in den finnisch-ugrischen Sprachen. *Acta Linguistica Academiae Scientiarum Hungaricae* 5, 21-23.
- Ito, Junko, and Armin Mester, 1992. Weak layering and word binarity. Ms. University of California, Santa Cruz.
- Jackson, Michel, 1987. A metrical analysis of the pitch accent system of the Seminole verb. In: Pamela Munro, ed., *Muskogean Linguistics*. UCLA Occasional Papers in Linguistics 6, 81-95. Department of Linguistics, University of California, Los Angeles.
- Jha, Subhadra, 1940-1944. Maithili phonetics. *Indian Linguistics* 8, 435-459.
- Jha, Subhadra, 1958. *The Formation of the Maithili Language*. London: Luzac.
- Kager, René, 1989. *A Metrical Theory of Stress and Destressing in English and Dutch*. Linguistic Models 14. Dordrecht: Foris.

- Kager, René, 1993. Alternatives to the iambic-trochaic law. *Natural Language and Linguistic Theory* 11, 381-432.
- Kager, René, 1994. Ternary rhythm in alignment theory. Ms. Research Institute for Language and Speech, Utrecht University. ROA-35, Rutgers Optimality Archive, <http://ruccs.rutgers.edu/roa.html>.
- Kager, René, 1995. Review article. *Phonology* 12, 437-464.
- Kenstowicz, Michael, 1995. Cyclic vs. non-cyclic constraint evaluation. *Phonology* 12, 397-436.
- Key, Mary Ritchie, 1968. *Comparative Tacanan Phonology*. Janua Linguarum, Series practica 50. The Hague: Mouton.
- Knudson, Lyle M., 1975. A natural phonology and morphophonemics of Chimalapa Zoque. *Papers in Linguistics* 8, 283-346.
- Kroeber, A. L., 1963. Yokuts dialect survey. *University of California Archaeological Records* 11.3, 177-251.
- Kuznecova, A. N., E. A. Xelimskij, and E. V. Gruskina, 1980. *Očerki po sel'kupkomu jazyku*. Izdatel'stvo Moskovskogo Universiteta, Mosocw.
- Leer, Jeff, 1985a. Prosody in Alutiiq (the Koniag and Chugach dialects of Alaskan Yupik). In: Michael Krauss, ed., *Yupik Eskimo Prosodic Systems: Descriptive and Comparative Studies*, 77-133. Alaska Native Center, Fairbanks.
- Leer, Jeff, 1985b. Evolution of prosody in the Yupik languages. In: Michael Krauss, ed., *Yupik Eskimo Prosodic Systems: Descriptive and Comparative Studies*, 135-157. Alaska Native Center, Fairbanks.
- Leer, Jeff, 1985c. Toward a metrical interpretation of Yupik prosody. In: Michael Krauss, ed., *Yupik Eskimo Prosodic Systems: Descriptive and Comparative Studies*, 159-172. Alaska Native Center, Fairbanks.
- Lehrdahl, Fred, and Ray Jackendoff, 1983. *A Generative Theory of Tonal Music*. Cambridge, MA: MIT Press
- LeSourd, Philip S., 1993. *Accent and Syllable Structure in Passamaquoddy*. New York: Garland.
- Levin, Juliette, 1988. Bidirectional foot construction as a window on level ordering. In: Michael Hammond and Michael Noonan, eds., *Theoretical Morphology*, 339-52. Orlando, Florida: Academic Press.
- Liberman, Mark, 1975. *The intonational system of English*. Ph. D. dissertation. Massachusetts Institute of Technology, Cambridge.
- Liberman, Mark, and Alan Prince, 1977. On stress and linguistic rhythm. *Linguistic Inquiry* 8, 249-336.

- Lombardi, Linda, and John McCarthy, 1991. Prosodic circumscription in Choctaw morphology. *Phonology* 8, 37-72.
- Lynch, John D., 1974. Lenakel phonology. Ph. D. dissertation. University of Hawaii.
- Lynch, John D., 1977. Lenakel Dictionary. Pacific Linguistics C55. Australian National University, Canberra.
- Lynch, John D., 1978. A Grammar of Lenakel. Pacific Linguistics B55. Australian National University, Canberra.
- Manning, Margaret, and Naomi Sagers, 1977. A tentative phonemic analysis of Ningil. In: Richard Loving, ed., *Phonologies of Five Papua New Guinea Languages*, 49-71. Summer Institute of Linguistics, Ukarumpa, Papua New Guinea.
- Matteson, Esther, 1965. The Piro (Arawakan) Language. University of California Publications in Linguistics 22. Berkeley: University of California Press.
- McArthur, Henry, and Lucille McArthur, 1956. Aguacatec Mayan phonemes in the stress group. *International Journal of American Linguistics* 22, 72-76.
- McCarthy, John, 1979. On stress and syllabification. *Linguistic Inquiry* 10, 443-465.
- McCarthy, John and Alan Prince, 1986. Prosodic morphology. ms., University of Massachusetts and Brandeis University, Waltham, Massachusetts.
- McCarthy, John and Alan Prince, 1993a. 1993. Prosodic Morphology I: Constraint Interaction and Satisfaction. To appear, MIT Press. Technical Report #3, Rutgers University Center for Cognitive Science.
- McCarthy, John and Alan Prince, 1993b. Generalized Alignment. In: Geert Booij and Jaap van Marle, eds., *Yearbook of Morphology 1993*. Dordrecht: Kluwer.
- McCarthy, John and Alan Prince, 1995. Faithfulness and Reduplicative Identity. In: J. Beckman, S. Urbanczyk, and L. Walsh, eds., *University of Massachusetts Occasional Papers in Linguistics 18: Papers in Optimality Theory*. Graduate Linguistic Student Association, Amherst.
- McDonald, M., and Stephen A. Wurm, 1979. Basic Materials in Wangkumara (Galali): Grammar, Sentences, and Vocabulary. Pacific Linguistics B65. Australian National University, Canberra.
- Michelson, Karin, 1988. A Comparative Study of Lake-Iroquoian Accent. Dordrecht: Kluwer Academic Publishers.
- Mitchell, T. F., 1960. Prominence and syllabification in Arabic. *Bulletin of the School of Oriental and African Studies* 23, 369-389.
- Mithun, Marianne, and Hasan Basri, 1985. The phonology of Selayarese. *Oceanic Linguistics* 25.1-2, 210-254.
- Munro, Pamela, and Charles Ulrich, 1984. Structure-preservation and Western Muskogean rhythmic lengthening. *West Coast Conference on Formal Linguistics* 3, 191-202.

- Nespor, Marina, and Irene Voegel, 1986. *Prosodic Phonology*. Dordrecht: Foris.
- Newman, Stanley, 1944. *Yokuts Language of California*. Viking Fund Publications in Linguistics 2. New York.
- Nicklas, Thurston Dale, 1972. *The Elements of Choctaw*. Ph. D. dissertation. University of Michigan, Ann Arbor.
- Nicklas, Thurston Dale, 1975. Choctaw morphophonemics. In: James M. Crawford, ed., *Studies in Southeastern Indian Languages*, 237-250. Athens: University of Georgia Press.
- Osborn, Henry, 1966. Warao I: phonology and morphophonemics. *International Journal of American Linguistics* 32, 108-123.
- Osumi, Midori, 1995. *Tinrin Grammar*. Oceanic Linguistics Special Publication 25. Honolulu: University of Hawaii Press.
- Payne, David, 1990. Accent in Aguaruna. In: Doris L. Payne, ed., *Amazonian Linguistics: Studies in Lowland South American Languages*, 161-184. Austin: University of Texas Press.
- Payne, David, 1990. *The Phonology and Morphology of Axininca Campa*. Summer Institute of Linguistics and University of Texas, Arlington.
- Payne, Judith, 1990. Asheninca stress patterns. In: Doris L. Payne, ed., *Amazonian Linguistics: Studies in Lowland South American Languages*, 185-209. Austin: University of Texas Press.
- Poppe, Nicholas, 1960. *Buriat Grammar*. Uralic and Altaic Series 2. Indiana University, Bloomington.
- Poppe, Nicholas, 1962. *Uzbek Newspaper Reader*. Uralic and Altaic Series 10. Indiana University, Bloomington.
- Poppe, Nicholas, 1970. *Mongolian Language Handbook*. Center for Applied Linguistics, Washington D. C.
- Prince, Alan, 1980. A metrical theory for Estonian quantity. *Linguistic Inquiry* 11, 511-562.
- Prince, Alan, 1983. Relating to the grid. *Linguistic Inquiry* 14, 19-100.
- Prince, Alan, 1985. Improving tree theory. *Berkely Linguistics Society* 11, 471-490.
- Prince, Alan, 1991. Quantitative consequences of rhythmic organization. In: Karen Deaton, Manuela Noske, and Michael Ziolkowski, eds., *CLS 26-II: Papers from the Parasession on the Syllable in Phonetics and Phonology*. Chicago Linguistics Society, Chicago.
- Prince, Alan, and Paul Smolensky, 1993. *Optimality Theory: Constraint Interaction in Generative Grammar*. To appear, MIT Press. Technical Report #2, Rutgers University Cognitive Science Center.
- Rice, Curtis, 1988. Stress Assignment in the Chugach dialect of Alutiiq. *Chicago Linguistics Society* 24, 304-315.

- Rice, Curtis, 1990. Pacific Yupik: implications for metrical theory. Coyote Papers. Department of Linguistics, University of Arizona, Tuscon.
- Roberts, John R., 1987. Amele. Guilford, England: Biddles.
- Rubach, Jerzey, and Geert Booij, 1985. A grid theory of stress in Polish. *Lingua* 66, 281-319.
- Sapir, Edward, 1930. Southern Paiute, a Shoshonean language. *Proceedings of the American Academy of Arts and Sciences* 65, 1-296.
- Sapir, Edward, 1949. The psychological reality of phonemes. In: David G. Mandelbaum, ed., *Selected writings of Edward Sapir in language, culture, and personality*, 46-60.
- Seiler, Hansjakob, 1965. Accent and morphophonemics in Cahuilla and Uto-Aztecán. *International Journal of American Linguistics* 31, 50-59.
- Seiler, Hansjakob, 1967. Structure and reconstruction in some Uto-Aztecán languages. *International Journal of American Linguistics* 33, 135-147.
- Seiler, Hansjakob, 1977. *Cahuilla Grammar*. Banning, California: Malki Museum Press.
- Seiler, Hansjakob, and Kojiro Hioki, 1979. *Cahuilla Dictionary*. Banning, California: Malki Museum Press.
- Selkirk, Elisabeth O., 1980a. Prosodic domains in phonology: Sanskrit revisited. In: Mark Aronoff and Mary-Louise Kean, eds., *Juncture*, 107-129. Saratoga, California: Anma Libri.
- Selkirk, Elisabeth O., 1980b. The role of prosodic categories in English word stress. *Linguistic Inquiry* 11, 563-605.
- Selkirk, Elisabeth O., 1984. *Phonology and Syntax: The Relation between Sound and Structure*. Cambridge, MA: MIT Press.
- Street, John C., 1963. *Khalkha Structure*. Uralic and Altaic series 24. Indiana University, Bloomington.
- Thompson, David A., 1976. A phonology of Kuuku-Ya?u. In: Peter Sutton, ed., *Languages of Cape York*, 213-235. Australian Institute of Aboriginal Studies, Canberra.
- Tryon, Darrell T., 1967. *Nengone grammar*. Pacific Linguistics B6. Australian National University, Canberra.
- Tryon, Darrell T., 1970. *An introduction to Maranungku*. Pacific Linguistics B15. Australian National University, Canberra.
- Tyhurst, James J., 1987. Accent shift in Seminole nouns. In: Pamela Munro, ed., *Muskogean linguistics*. UCLA Occasional Papers in Linguistics 6, 161-170.
- Ulrich, Charles, 1986. *Choctaw Morphophonology*. Ph. D. dissertation. University of California, Los Angeles.

Voegelin, Charles, 1935. Tübatulabal grammar. University of California Publications in American Archaeology and Ethnology, vol. 34, no. 2, 55-189. Berkeley: University of California Press.

Walker, Rachel, 1996. Prominence-driven stress. Ms. University of California, Santa Cruz.

Zec, Draga, 1994. Sonority Constraints on Prosodic Structure. New York: Garland.